



# Buffetkultur. Genuss. Erlebnis.

## Buffet Culture. Pleasure. Experience.



WMF Professional  
Gesamtprogramm | Complete Range

2018/2019





Buffetkultur. Genuss. Erlebnis.  
Buffet Culture. Pleasure. Experience.

---

# WMF. Genussmomente auf ganzer Linie.

## WMF. Moments of pleasure all along the line.

---



In der Hotellerie und der Gastronomie gilt es, seine Gäste jeden Tag aufs Neue zu überzeugen und zu begeistern.

Ein wesentlicher Schlüssel zum Erfolg liegt in einem durchgängigen Gesamtkonzept: der stilbewussten Gestaltung des Interieurs, einer inspirierten und abwechslungsreichen Speisekarte gepaart mit einem herausragenden Service. Für den Gast steht dabei der gedeckte Tisch im Mittelpunkt – hier inszenieren Sie das Menü zum kulinarischen Erlebnis.

Ganz gleich ob elegant, bodenständig, modern oder puristisch: mit unserem umfangreichen Portfolio runden wir Ihr Konzept ideal ab. Und das nicht nur im à la carte Betrieb: für den Einsatz am Buffet überzeugen unsere Chafing Dishes und Buffetsysteme mit höchster Funktionalität, großer Flexibilität und beeindruckender Vielfalt.

Gerne unterstützen wir Sie dabei, passend auf Ihre Wünsche und Bedürfnisse, die perfekte Lösung zu erarbeiten. Mit individueller Beratung, gewohnter WMF Qualität und zuverlässigem Service.

Erleben Sie auch in diesem Jahr die Vielfalt von WMF Professional. Wir sind gerne für Sie da.

In the hotel industry as well as in the gastronomy business, it is of great importance to convince and inspire your guests every day.

An essential key to success is a consistent overall concept: a style-conscious interior design, just as an inspired and varied menu paired with an outstanding service. For guests, the laid table is the center of attention – here you stage the menu for a culinary experience.

Whether elegant, long-established, modern or puristic: With our extensive portfolio we complement your concept ideally. This does not only apply to an à la carte service. Our chafing dishes and buffet systems impress with high functionality, great flexibility and a great product variety for every buffet setting.

We are looking forward assisting you in finding the perfect solution to suit your wishes and needs. Providing individual advice with well-known WMF quality and absolute reliable service.

Experience the diversity of WMF Professional again this year. We are pleased to be at your service.



**Alexander Pick**  
Head of Sales WMF  
Business Unit Hotel

**Christoph Berscheid**  
Leiter Vertrieb Deutschland  
WMF GastroProfi







---

Leidenschaft für Tischkultur.  
Made in Geislingen.

Passion for table culture.  
Made in Geislingen.

---





Bestecke, Table Top und Buffet Elemente – alle WMF Produkte sind Ausdruck unserer Leidenschaft für Tischkultur. Sie sind hochwertige, perfekt verarbeitete Werkzeuge, die Sinne anregen, Geschmackserlebnisse steigern und das Ambiente zum Glänzen bringen. Sie transportieren von weltweit 40 Standorten aus unsere Philosophie: Ihr Gastronomiekonzept auf den Punkt und auf den Tisch zu bringen.

Tischkultur ist ständig in Bewegung. Sie lebt vom Gespür für den Moment. Für den perfekten Augenblick, in dem alles stimmig ist. Dahinter steht die Expertise und Zuverlässigkeit von WMF mit klar aufeinander abgestimmten Arbeitsprozessen in Forschung, Design, Entwicklung und Fertigung. Aus unserem vielfältigen Produktportfolio entstehen innovative, ganzheitlich abgestimmte Lösungen aus einer Hand. Für Ihren individuellen Stil. Für formvollendete Funktionalität, Präzision und Beständigkeit, die sich im Gastronomiealltag bewähren – seit 1853.

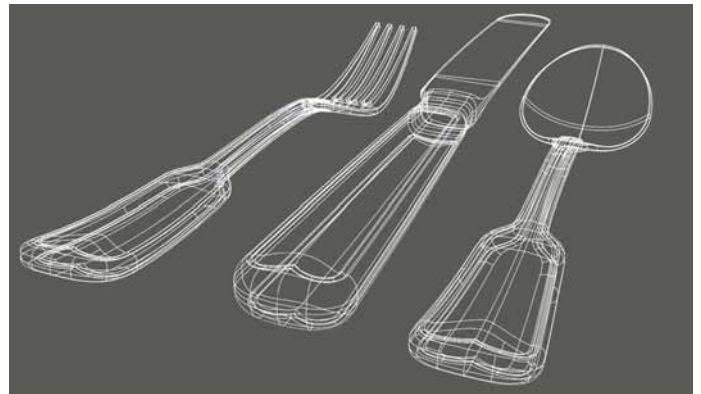
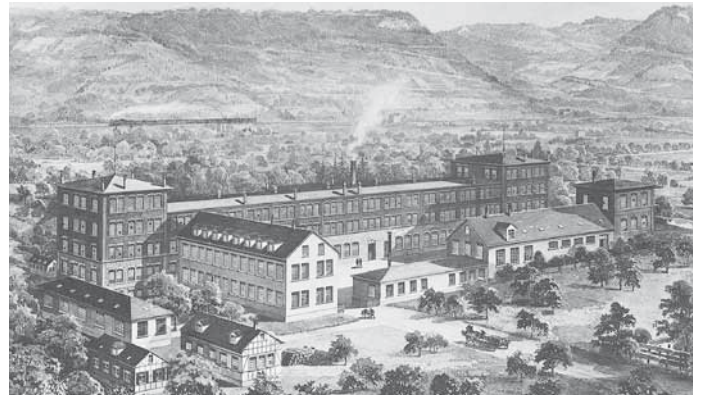

Cutlery, table top and buffet wares – all WMF products are expressions of our passion for table culture. They are high-quality, perfectly crafted implements that stimulate the senses, enhance taste experiences and add sparkle to ambience. From 40 locations worldwide they impart our philosophy: expression for your gastronomic concept and its presentation on the table.

Table culture is constantly in motion. It thrives in the feeling for the moment. For that perfect instant, when everything is exactly right. Brought about with the expertise and dependability of WMF and our finely tuned workflows in research, design, development and production. Innovative, totally harmonised, single-source solutions come from within our extensive product portfolio. For your individual style. For form-perfect functionality, precision and lasting good appearance tried and tested in the daily routines of gastronomy and catering – since 1853.







# Glanzstücke mit Geschichte: Die Kunst der Reparatur-Werkstatt von WMF.

Showpieces with a history:  
taken care of by our WMF repair service.



Was heute die qualitative Hochwertigkeit der Produkte von WMF ausmacht, findet seine Ursprünge in der traditionellen Handwerkskunst. Daher ist es für uns auch nach über 160 Jahren Unternehmensgeschichte selbstverständlich, Werkzeug und Hand anzulegen, um ein Produkt aufzuarbeiten oder individuell zu verschönern. Die besondere Expertise der WMF Reparatur-Werkstatt reicht in alle verarbeitenden Edelmetallkünste hinein: vom Ausbeulen, Löten und Schweißen über die Versilberung, das Vergolden sowie den Austausch von Knöpfen und Griffen bis hin zur Umsetzung kundenindividueller Design-Ansprüche.

Mit Hingabe und Detailverliebtheit versetzen wir seltene und lieb gewonnene Stücke wieder in ihren ursprünglichen Zustand. Dieses Werteverständnis pflegt WMF seit jeher – lange bevor die Begriffe Nachhaltigkeit oder Vintage zum Trend wurden. Der Service ist in der Branche etabliert und geschätzt: Beispielsweise arbeiteten wir für den letzten Auftrag des Bundespräsidialamtes knapp 900 Besteckteile auf – denn dort deckt man den Tisch für Gäste bereits seit rund 60 Jahren mit WMF in Silber. Einen weiteren Weg haben mehrere Rinderbrustwagen aus

Madeira zurückgelegt. Nach jahrzehntelangem Einsatz im Belmond Reid's Palace kamen sie schließlich zur originalgetreuen Aufarbeitung in die Werkstatt von WMF. Bei solch sensiblen, historischen Stücken ist die professionelle Aufbereitung oft die letzte Rettung. Diese Tatsache weckt die Leidenschaft unserer Mitarbeiter, ein Stück Geschichte zu wahren.

The high quality that is characteristic of WMF products today has its roots embedded in traditional craftsmanship. This is why, even after our company history that dates back over 160 years, it is second nature for us to use our hands and tools to recondition products or to individually embellish them. The specialist expertise at the WMF repair service covers all processed precious metal arts: from flattening, soldering and welding through to silverplating, goldplating and changing handles and buttons to meet customer-specific design demands.

With devotion and a love for detail, we restore rare and treasured pieces back to their original condition. WMF has always had this understanding of values – long before

the terms sustainable and vintage became trendy. The service is established and valued within the sector: For example, as part of the recent order from the German Presidential Office, we restored nearly 900 pieces of cutlery – since for the last 60 years its table has been laid for guests using WMF silver. A number of roast beef serving trolleys have also travelled a long way from Madeira. After decades of use at Belmond Reid's Palace, they finally arrived at the WMF workshop to be restored to their former glory. With such delicate, historical pieces, professional restoration is often the last hope. This fact awakens the passion of our employees who enjoy preserving a piece of history.





# Inhalt

contents



## Besteck flatware

Besteckkollektionen  
flatware collections

Besteck Ergänzungsteile  
neutral serving pieces

Besteck-Veredelungen  
cutlery finishing techniques

## Table Top table top

WMF firstglass

Tee & Kaffee  
tea & coffee

Weinkühler & Ständer  
wine cooler & stands

Serviergeräte  
serving utensils

Diverses  
miscellaneous

Körbe & Schalen  
baskets & bowls

Kerzen & Leuchter  
candles & lamps

Vasen  
vases

Mühlen & Menagen  
grinding & condiment sets

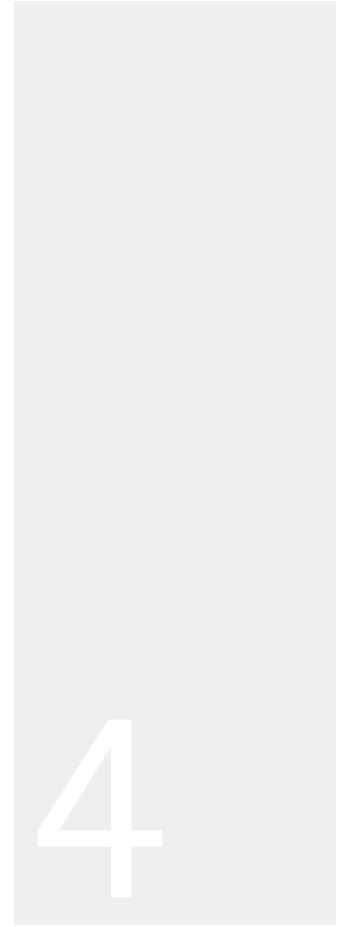
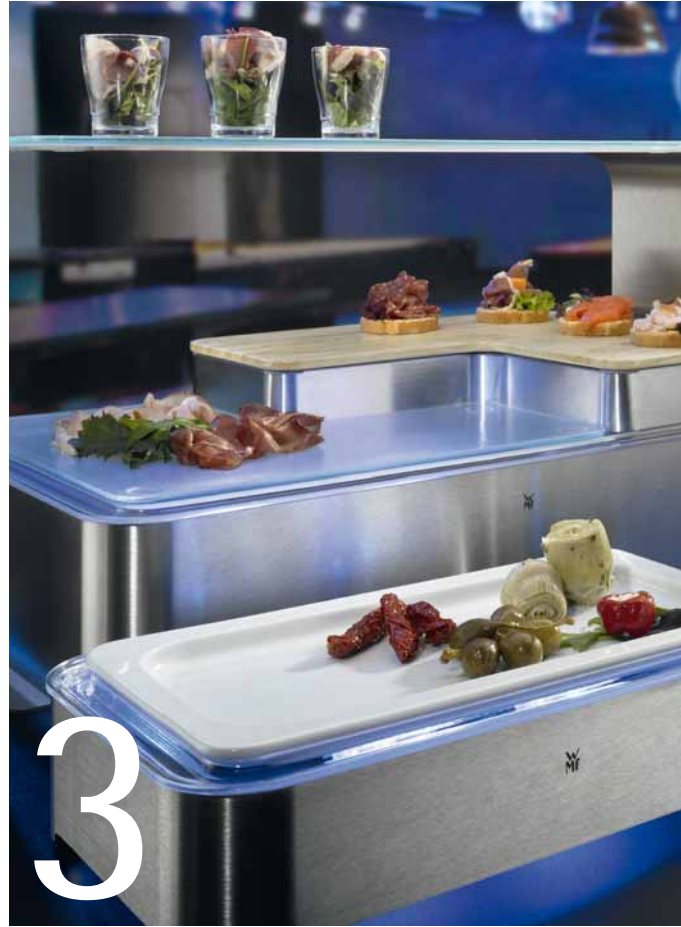

## Buffet buffet

Buffet in Ihrem Takt.  
buffet to your own beat.

WMF Quadro

Chafing Dishes Induktion  
chafing dishes induction

Chafing Dishes

Chafing Dish Zubehör  
chafing dish accessories

Coffee Urns

Dispenser

Getränkekühler  
beverage cooler

Etagéren  
etageres

Plattenständer  
tray stands

Platten & Tablett  
platters & trays

Pflegemittel  
cleaning aids

## Gesamt-Inhaltsverzeichnis alphabetical index

## A – Z



# Besteck

flatware







# Besteckkollektionen

flatware collections

NEU NEW



**MILANO 4000**

■ ■  
Seite 14 | page 14



**TRIOMPHE 2000**

■ ■  
Seite 18 | page 18



**BAROCK 3000**

■ ■  
Seite 22 | page 22



**JUWEL 7300**

■ ■  
Seite 26 | page 26



**SOLID 7900**

■ ■  
Seite 42 | page 42



**BASE 2300**

■  
Seite 46 | page 46



**UNIC 5300**

■ ■  
Seite 50 | page 50



**GASTRO 0800**

■  
Seite 54 | page 54



**FLAIR 1100**

■ ■  
Seite 70 | page 70



**CLUB 4700**

■  
Seite 74 | page 74



**BAGUETTE 0100**

■ ■ ■ ■  
Seite 78 | page 78



**MONDIAL 6200**

■ ■  
Seite 82 | page 82





**NORDIC 7200**

■ ■  
Seite 30 | page 30



**TELOS 1800**

■ ■  
Seite 34 | page 34



**CASINO 9000**

■ ■  
Seite 38 | page 38



**SIGNUM 1900**

■ ■  
Seite 58 | page 58



**CONTOUR 0200**

■ ■  
Seite 62 | page 62



**BISTRO 0400**

■ ■  
Seite 66 | page 66



**RESIDENCE 4800**

■ ■  
Seite 86 | page 86



**METROPOLITAN 5400**

■ ■  
Seite 90 | page 90

■ perfekt versilbert  
perfectly silver-plated

■ Cromargan®, poliert  
Cromargan®, polished

■ Stone-washed







NEU NEW

Erhaben.  
Sublime.

Lebendig.  
Vibrant.

Formvollendet.  
Perfect.

MILANO

■ 54.4001.6030

■ 54.4001.6040

**Menuelöffel**

206 mm/8 in.  
table spoon  
cuiller de table  
cuchara mesa  
cucchiaio tavola

■ 54.4036.6030

■ 54.4036.6040

**Fischmesser**

232 mm/9 in.  
fish knife  
couteau à poisson  
cuchillo pescado  
coltello pesce

■ 54.4002.6030

■ 54.4002.6040

**Menuegabel**

205 mm/8 in.  
table fork  
fourchette de table  
tenedor mesa  
forchetta tavola

■ 54.4064.6030

■ 54.4064.6040

**Kuchengabel**

146 mm/5<sup>12</sup>/<sub>16</sub> in.  
cake fork  
fourchette à gâteau  
tenedor lunch  
forchetta per dolce

■ 54.4003.6039

■ 54.4003.6049

**Menuemesser\*\***

238 mm/9<sup>1</sup>/<sub>2</sub> in.  
table knife\*\*  
couteau de table\*\*  
cuchillo mesa\*\*  
coltello tavola cutinat\*\*

■ 54.4004.6030

■ 54.4004.6040

**Vorspeisenlöffel**

186 mm/7<sup>4</sup>/<sub>16</sub> in.  
dessert spoon  
cuiller à dessert  
cuchara postre  
cucchiaio frutta

■ 54.4005.6030

■ 54.4005.6040

**Vorspeisengabel**

185 mm/7<sup>1</sup>/<sub>16</sub> in.  
dessert fork  
fourchette à dessert  
tenedor postre  
forchetta frutta

■ 54.4006.6039

■ 54.4006.6049

**Vorspeisen-  
messer\*\***

215 mm/8<sup>1</sup>/<sub>2</sub> in.  
dessert knife\*\*  
couteau à dessert\*\*  
cuchillo postre\*\*  
coltello frutta\*\*

■ 54.4007.6030

■ 54.4007.6040

**Kaffeelöffel**

145 mm/5<sup>12</sup>/<sub>16</sub> in.  
tea/coffee spoon  
cuiller à café  
cuchara café  
cucchiaio caffè/té

■ 54.4009.6030

■ 54.4009.6040

**Espresso- /  
Mokkalöffel**

120 mm/4<sup>12</sup>/<sub>16</sub> in.  
demi-tasse spoon  
cuiller à mocca  
cuchara moca  
cucchiaio moca

■ 54.4011.6030

■ 54.4011.6040

**Gourmetlöffel**

180 mm/7 in.  
gourmet spoon  
cuiller à sauce  
cuchara gourmet  
cucchiaio gourmet

■ 54.4035.6030

■ 54.4035.6040

**Fischgabel**

197 mm/7<sup>1</sup>/<sub>2</sub> in.  
fish fork  
fourchette à poisson  
tenedor pescado  
forchetta pesce

VPE 12 Stk. / Unit 12 pcs.

■ perfekte Versilberung /  
perfectly silverplated■ Cromargan®, poliert /  
stainless 18/10, polished\*\* Klingenstahl mit Wellenschliff /  
monobloc with serrated edge



**NEU NEW**

- **54 4000 6030**  
perfekt versilbert  
perfectly silverplated  
chromage parfait  
plateado perfecto  
perfetta placcatura in argento
- **54 4000 6040**  
Cromargan®, poliert  
Cromargan®, polished  
Cromargan®, poli  
Cromargan®, pulido  
Cromargan®, lucido

Milano steht für italienische Lebensfreude. Seine umschmeichelnde Form erinnert entfernt an die einladenden Terrassen des Landes und es schmiegt sich durch seine pittoreske Art in das südländische Gesamtbild ein.

Milano stands for Italian zest for life. Its flattering form is faintly redolent of the country's inviting terraces and it fits nicely into the overall Mediterranean look with its picturesque style.

**MILANO**  
4000





Samtiges Genusserlebnis mit TRIOMPHE  
in glasperlengestralter Ausführung.  
Velvety experience of pleasure with the  
glass blasted version of TRIOMPHE.



Exklusiv.  
Exclusive.

Auffallend.  
Eye-catching.

Elegant.  
Elegant.

TRIOMPHE

■ 54.2001.6030  
■ 54.2001.6040

**Menuelöffel**  
215 mm/8½ in.  
table spoon  
cuiller de table  
cuchara mesa  
cucchiaio tavola



■ 54.2002.6030  
■ 54.2002.6040

**Menuegabel**  
214 mm/8½ in.  
table fork  
fourchette de table  
tenedor mesa  
forchetta tavola



■ 54.2003.6037  
■ 54.2003.6047

**Menuemesser\***  
248 mm/9¾ in.  
table knife\*  
couteau de table\*  
cuchillo mesa\*  
coltello tavola cutinato\*



■ 54.2003.6039  
■ 54.2003.6049

**Menuemesser\*\***  
248 mm/9¾ in.  
table knife\*\*  
couteau de table\*\*  
cuchillo mesa\*\*  
coltello tavola cutinato\*\*



■ 54.2004.6030  
■ 54.2004.6040

**Vorspeisenlöffel**  
196 mm/7½ in.  
dessert spoon  
cuiller à dessert  
cuchara postre  
cucchiaio frutta



■ 54.2005.6030  
■ 54.2005.6040

**Vorspeisengabel**  
195 mm/7½ in.  
dessert fork  
fourchette à dessert  
tenedor postre  
forchetta frutta



■ 54.2006.6037  
■ 54.2006.6047

**Vorspeisen-  
messer\***  
226 mm/9 in.  
dessert knife\*  
couteau à dessert\*  
cuchillo postre\*  
coltello frutta\*



■ 54.2006.6039  
■ 54.2006.6049

**Vorspeisen-  
messer\*\***  
226 mm/9 in.  
dessert knife\*\*  
couteau à dessert\*\*  
cuchillo postre\*\*  
coltello frutta\*\*



■ 54.2007.6030  
■ 54.2007.6040

**Kaffeelöffel**  
136 mm/5½ in.  
tea/coffee spoon  
cuiller à café  
cuchara café  
cucchiaio caffè/té



■ 54.2009.6030  
■ 54.2009.6040

**Espresso- /  
Mokkalöffel**  
108 mm/4¼ in.  
demi-tasse spoon  
cuiller à mocca  
cuchara moca  
cucchiaio moca



■ 54.2010.6030  
■ 54.2010.6040

**Vorspeisen- /  
Dessertlöffel**  
156 mm/6¼ in.  
coffee/tea spoon, large  
cuiller à café/thé, grande  
cuchara à café/té, grande  
cucchiaio caffè/té, grande



■ 54.2011.6030  
■ 54.2011.6040

**Gourmetlöffel**  
196 mm/7¾ in.  
gourmet spoon  
cuiller à sauce  
cuchara gourmet  
cucchiaio gourmet



■ 54.2035.6030  
■ 54.2035.6040

**Fischgabel**  
190 mm/7½ in.  
fish fork  
fourchette à poisson  
tenedor pescado  
forchetta pesce



■ 54.2036.6030  
■ 54.2036.6040

**Fischmesser**  
215 mm/8½ in.  
fish knife  
couteau à poisson  
cuchillo pescado  
coltello pesce



■ 54.2040.6030  
■ 54.2040.6040

**Austerngabel**  
149 mm/6 in.  
oyster fork  
fourchette à huîtres  
tenedor ostras  
forchetta per ostriche



■ 54.2064.6030  
■ 54.2064.6040

**Kuchengabel**  
157 mm/6¼ in.  
cake fork  
fourchette à gâteau  
tenedor lunch  
forchetta per dolce



■ 54.2066.6039  
■ 54.2066.6049

**Brot- /  
Buttermesser\*\***  
170 mm/6½ in.  
bread/butter knife\*\*  
couteau de table\*\*  
cuchillo lunch\*\*  
coltello per dolce\*\*



■ 54.2072.6030  
■ 54.2072.6040

**Limolöffel**  
220 mm/8½ in.  
iced tea spoon  
cuiller à soda  
cuchara refresco  
cucchiaio bibita



■ 54.2078.6039  
■ 54.2078.6049

**Steakmesser\*\***  
247 mm/9¾ in.  
steak knife\*\*  
couteau à steak\*\*  
cuchillo steak\*\*  
coltello da bistecca\*\*



■ 54.2089.6030  
■ 54.2089.6040

**Tassenlöffel**  
174 mm/7 in.  
round bowl soup spoon  
cuiller à bouillon  
cuchara sopa  
cucchiaio da brodo



VPE 12 Stk. / Unit 12 pcs.

- perfekte Versilberung / perfectly silverplated
- Cromargan®, poliert / stainless 18/10, polished

\* Hohlheft mit Wellenschliff / hollow-handled with serrated edge

\*\* Klingenstahl mit Wellenschliff / monobloc with serrated edge





■ **54 2000 6030**  
 perfekt versilbert  
 perfectly silverplated  
 chromage parfait  
 plateado perfecto  
 perfetta placcatura in argento

■ **54 2000 6040**  
 Cromargan®, poliert  
 Cromargan®, polished  
 Cromargan®, poli  
 Cromargan®, pulido  
 Cromargan®, lucido

Triomphe verleiht dem klassischen Besteckmuster „Augsburger Faden“ modernen Zeitgeist. In Kombination mit feiner Tischwäsche und edlem Porzellan ist das Modell der Glanzpunkt auf dem gedeckten Tisch.

Triomphe gives the classic “Augsburger Faden” cutlery design a modern twist. Combined with fine table linen and elegant porcelain, this collection is a sparkling focal point of any well-laid table.

**TRIOMPHE**  
 2000







Fürstlich.  
Regal.

Edel.  
Noble.

Traditionell.  
Traditional.

**BAROCK**

■ 54.3001.6030  
■ 54.3001.6040

**Menuelöffel**  
213 mm/8½ in.  
table spoon  
cuiller de table  
cuchara mesa  
cucchiaio tavola



■ 54.3002.6030  
■ 54.3002.6040

**Menuegabel**  
212 mm/8½ in.  
table fork  
fourchette de table  
tenedor mesa  
forchetta tavola



■ 54.3003.6037  
■ 54.3003.6047

**Menuemesser\***  
235 mm/9½ in.  
table knife\*  
couteau de table\*  
cuchillo mesa\*  
coltello tavola cutinato\*



■ 54.3003.6039  
■ 54.3003.6049

**Menuemesser\*\***  
235 mm/9½ in.  
table knife\*\*  
couteau de table\*\*  
cuchillo mesa\*\*  
coltello tavola cutinato\*\*



■ 54.3004.6030  
■ 54.3004.6040

**Vorspeisenlöffel**  
196 mm/7¾ in.  
dessert spoon  
cuiller à dessert  
cuchara postre  
cucchiaio frutta



■ 54.3005.6030  
■ 54.3005.6040

**Vorspeisengabel**  
195 mm/7¾ in.  
dessert fork  
fourchette à dessert  
tenedor postre  
forchetta frutta



■ 54.3006.6037  
■ 54.3006.6047

**Vorspeisen-  
messer\***  
217 mm/8½ in.  
dessert knife\*  
couteau à dessert\*  
cuchillo postre\*  
coltello frutta\*



■ 54.3006.6039  
■ 54.3006.6049

**Vorspeisen-  
messer\*\***  
217 mm/8½ in.  
dessert knife\*\*  
couteau à dessert\*\*  
cuchillo postre\*\*  
coltello frutta\*\*



■ 54.3007.6030  
■ 54.3007.6040

**Kaffeelöffel**  
136 mm/5½ in.  
tea/coffee spoon  
cuiller à café  
cuchara café  
cucchiaio caffè/té



■ 54.3009.6030  
■ 54.3009.6040

**Espresso- /  
Mokkalöffel**  
108 mm/4½ in.  
demi-tasse spoon  
cuiller à mocca  
cuchara moca  
cucchiaio moca



■ 54.3010.6030  
■ 54.3010.6040

**Vorspeisen- /  
Dessertlöffel**  
156 mm/6¼ in.  
coffee/tea spoon, large  
cuiller à café/thé, grande  
cuchara à café/té, grande  
cucchiaio caffè/té, grande



■ 54.3011.6030  
■ 54.3011.6040

**Gourmetlöffel**  
194 mm/7¾ in.  
gourmet spoon  
cuiller à sauce  
cuchara gourmet  
cucchiaio gourmet



■ 54.3035.6030  
■ 54.3035.6040

**Fischgabel**  
190 mm/7½ in.  
fish fork  
fourchette à poisson  
tenedor pescado  
forchetta pesce



■ 54.3036.6030  
■ 54.3036.6040

**Fischmesser**  
214 mm/8½ in.  
fish knife  
couteau à poisson  
cuchillo pescado  
coltello pesce



■ 54.3064.6030  
■ 54.3064.6040

**Kuchengabel**  
157 mm/6¼ in.  
cake fork  
fourchette à gâteau  
tenedor lunch  
forchetta per dolce



■ 54.3066.6039  
■ 54.3066.6049

**Brot- /  
Buttermesser\*\***  
170 mm/6¾ in.  
bread/butter knife\*\*  
couteau de table\*\*  
cuchillo lunch\*\*  
coltello per dolce\*\*



■ 54.3072.6030  
■ 54.3072.6040

**Limolöffel**  
220 mm/8¾ in.  
iced tea spoon  
cuiller à soda  
cuchara refresco  
cucchiaio bibita



■ 54.3078.6039  
■ 54.3078.6049

**Steakmesser\*\***  
242,5 mm/9½ in.  
steak knife\*\*  
couteau à steak\*\*  
cuchillo steak\*\*  
coltello da bistecca\*\*



■ 54.3089.6030  
■ 54.3089.6040

**Tassenlöffel**  
174 mm/7 in.  
round bowl soup spoon  
cuiller à bouillon  
cuchara sopa  
cucchiaio da brodo



VPE 12 Stk. / Unit 12 pcs.

■ perfekte Versilberung /  
perfectly silverplated

■ Cromargan®, poliert /  
stainless 18/10, polished

\* Hohlheft mit Wellenschliff /  
hollow-handled with serrated edge

\*\* Klingenstahl mit Wellenschliff /  
monobloc with serrated edge





■ **54 3000 6030**  
 perfekt versilbert  
 perfectly silverplated  
 chromage parfait  
 plateado perfecto  
 perfetta placcatura in argento

■ **54 3000 6040**  
 Cromargan®, poliert  
 Cromargan®, polished  
 Cromargan®, poli  
 Cromargan®, pulido  
 Cromargan®, lucido

Barock akzentuiert erlesene Menüfolgen mit seiner traditionellen Schönheit. Filigrane Ornamente und tropfenförmige Griffe unterstreichen die Eleganz festlicher Tafeln.

With its traditional beauty, Barock accentuates the fine-dining experience. Elegant embellishments and drop-shaped handles add to the sophistication of any festive table.

**BAROCK**  
 3000







Extravagant.  
Extravagant.

Außergewöhnlich.  
Extraordinary.

Brilliant.  
Brilliant.

JUWEL

■ 54.7301.6030  
■ 54.7301.6040

**Menuelöffel**

213 mm/8<sup>3</sup>/<sub>4</sub> in.  
table spoon  
cuiller de table  
cuchara mesa  
cucchiaio tavola



■ 54.7302.6030  
■ 54.7302.6040

**Menuegabel**

211 mm/8<sup>1</sup>/<sub>4</sub> in.  
table fork  
fourchette de table  
tenedor mesa  
forchetta tavola



■ 54.7303.6037  
■ 54.7303.6047

**Menuemesser\***

236 mm/9<sup>3</sup>/<sub>4</sub> in.  
table knife\*  
couteau de table\*  
cuchillo mesa\*  
coltello tavola cutinato\*



■ 54.7303.6039  
■ 54.7303.6049

**Menuemesser\*\***

239 mm/9<sup>1</sup>/<sub>2</sub> in.  
table knife\*\*  
couteau de table\*\*  
cuchillo mesa\*\*  
coltello tavola cutinato\*\*



■ 54.7304.6030  
■ 54.7304.6040

**Vorspeisenlöffel**

196 mm/7<sup>3</sup>/<sub>4</sub> in.  
dessert spoon  
cuiller à dessert  
cuchara postre  
cucchiaio frutta



■ 54.7305.6030  
■ 54.7305.6040

**Vorspeisengabel**

194 mm/7<sup>3</sup>/<sub>4</sub> in.  
dessert fork  
fourchette à dessert  
tenedor postre  
forchetta frutta



■ 54.7306.6037  
■ 54.7306.6047

**Vorspeisenmesser\***

212 mm/8<sup>1</sup>/<sub>4</sub> in.  
dessert knife\*  
couteau à dessert\*  
cuchillo postre\*  
coltello frutta\*



■ 54.7306.6039  
■ 54.7306.6049

**Vorspeisenmesser\*\***

220 mm/8<sup>3</sup>/<sub>4</sub> in.  
dessert knife\*\*  
couteau à dessert\*\*  
cuchillo postre\*\*  
coltello frutta\*\*



■ 54.7307.6030  
■ 54.7307.6040

**Kaffeelöffel**

136 mm/5<sup>1</sup>/<sub>4</sub> in.  
tea/coffee spoon  
cuiller à café  
cuchara café  
cucchiaio caffè/té



■ 54.7309.6030  
■ 54.7309.6040

**Espresso- / Mokkalöffel**

108 mm/4<sup>1</sup>/<sub>4</sub> in.  
demi-tasse spoon  
cuiller à moca  
cuchara moca  
cucchiaio moca



■ 54.7310.6030  
■ 54.7310.6040

**Vorspeisen- / Dessertlöffel**

159 mm/6<sup>1</sup>/<sub>4</sub> in.  
coffee/tea spoon, large  
cuiller à café/thé, grande  
cuchara à café/té, grande  
cucchiaio caffè/té, grande



■ 54.7311.6030  
■ 54.7311.6040

**Gourmetlöffel**

193 mm/7<sup>1</sup>/<sub>2</sub> in.  
gourmet spoon  
cuiller à sauce  
cuchara gourmet  
cucchiaio gourmet



■ 54.7335.6030  
■ 54.7335.6040

**Fischgabel**

190 mm/7<sup>1</sup>/<sub>2</sub> in.  
fish fork  
fourchette à poisson  
tenedor pescado  
forchetta pesce



■ 54.7336.6030  
■ 54.7336.6040

**Fischmesser**

214 mm/8<sup>1</sup>/<sub>2</sub> in.  
fish knife  
couteau à poisson  
cuchillo pescado  
coltello pesce



■ 54.7340.6030  
■ 54.7340.6040

**Austerngabel**

149 mm/5<sup>3</sup>/<sub>4</sub> in.  
oyster fork  
fourchette à huîtres  
tenedor ostras  
forchetta per ostriche



■ 54.7364.6030  
■ 54.7364.6040

**Kuchengabel**

158 mm/6<sup>1</sup>/<sub>4</sub> in.  
cake fork  
fourchette à gâteau  
tenedor lunch  
forchetta per dolce



■ 54.7366.6039  
■ 54.7366.6049

**Brot- / Buttermesser\*\***

170 mm/6<sup>3</sup>/<sub>4</sub> in.  
bread/butter knife\*\*  
couteau de table\*\*  
cuchillo lunch  
coltello per dolce\*\*



■ 54.7372.6030  
■ 54.7372.6040

**Limolöffel**

220 mm/8<sup>3</sup>/<sub>4</sub> in.  
iced tea spoon  
cuiller à soda  
cuchara refresco  
cucchiaio bibita



■ 54.7378.6039  
■ 54.7378.6049

**Steakmesser\*\***

239 mm/9<sup>1</sup>/<sub>2</sub> in.  
steak knife\*\*  
couteau à steak\*\*  
cuchillo steak\*\*  
coltello da bistecca\*\*



■ 54.7386.6039  
■ 54.7386.6049

**Obstmesser**

170 mm/6<sup>3</sup>/<sub>4</sub> in.  
fruit knife  
couteau à fruits  
cuchillo para fruta  
coltello da frutta



■ 54.7389.6030  
■ 54.7389.6040

**Tassenlöffel**

170 mm/6<sup>3</sup>/<sub>4</sub> in.  
round bowl soup spoon  
cuiller à bouillon  
cuchara sopa  
cucchiaio da brodo



VPE 12 Stk. / Unit 12 pcs.

■ perfekte Versilberung / perfectly silverplated

■ Cromargan®, poliert / stainless 18/10, polished

\* Hohlheft mit Wellenschliff / hollow-handled with serrated edge

\*\* Klingenstahl mit Wellenschliff / monobloc with serrated edge





■ **54 7300 6030**  
 perfekt versilbert  
 perfectly silverplated  
 chromage parfait  
 plateado perfecto  
 perfetta placcatura in argento

■ **54 7300 6040**  
 Cromargan®, poliert  
 Cromargan®, polished  
 Cromargan®, poli  
 Cromargan®, pulido  
 Cromargan®, lucido

Juwel ist das funkelnde Highlight für jedes gehobene Ambiente. Die aufwendige Facettierung am Griffende erinnert an den Schliff eines Edelsteins und stammt aus der Feder der Designerin Jette Joop.

Juwel is a sparkling highlight that adds to any sophisticated setting. The complex beveling at the end of the handles is reminiscent of finely-cut gemstones and is a product of the imagination of designer Jette Joop.

**JUWEL**  
 7300







Pur.  
Pure.

Minimalistisch.  
Minimalist.

Ästhetisch.  
Aesthetic.

NORDIC

■ 54.7201.6030  
■ 54.7201.6040

**Menuelöffel**

230 mm/9 in.  
table spoon  
cuiller de table  
cuchara mesa  
cucchiaio tavola



■ 54.7202.6030  
■ 54.7202.6040

**Menuegabel**

228 mm/9 in.  
table fork  
fourchette de table  
tenedor mesa  
forchetta tavola



■ 54.7203.6039  
■ 54.7203.6049

**Menuemesser\*\***

246 mm/9 3/4 in.  
table knife\*\*  
couteau de table\*\*  
cuchillo mesa\*\*  
coltello tavola cutinato\*\*



■ 54.7235.6030  
■ 54.7235.6040

**Fischgabel**

203 mm/8 in.  
fish fork  
fourchette à poisson  
tenedor pescado  
forchetta pesce



■ 54.7236.6030  
■ 54.7236.6040

**Fischmesser**

226 mm/9 in.  
fish knife  
couteau à poisson  
cuchillo pescado  
coltello pesce



■ 54.7240.6030  
■ 54.7240.6040

**Austerngabel**

149 mm/5 7/8 in.  
oyster fork  
fourchette à huîtres  
tenedor ostras  
forchetta per ostriche



■ 54.7204.6030  
■ 54.7204.6040

**Vorspeisenlöffel**

212 mm/8 1/2 in.  
dessert spoon  
cuiller à dessert  
cuchara postre  
cucchiaio frutta



■ 54.7264.6030  
■ 54.7264.6040

**Kuchengabel**

164 mm/6 1/2 in.  
cake fork  
fourchette à gâteau  
tenedor lunch  
forchetta per dolce



■ 54.7205.6030  
■ 54.7205.6040

**Vorspeisengabel**

210 mm/8 1/4 in.  
dessert fork  
fourchette à dessert  
tenedor postre  
forchetta frutta



■ 54.7266.6039  
■ 54.7266.6049

**Brot- /  
Buttermesser\*\***

170 mm/6 3/4 in.  
bread/butter knife\*\*  
couteau de table\*\*  
cuchillo mesa\*\*  
coltello per dolce\*\*



■ 54.7206.6039  
■ 54.7206.6049

**Vorspeisen-  
messer\*\***

226 mm/9 in.  
dessert knife\*\*  
cuiller à dessert\*\*  
cuchara postre\*\*  
cucchiaio frutta\*\*



■ 54.7272.6030  
■ 54.7272.6040

**Limolöffel**

220 mm/8 3/4 in.  
iced tea spoon  
cuiller à soda  
cuchara refresco  
cucchiaio bibita



■ 54.7207.6030  
■ 54.7207.6040

**Kaffeelöffel**

140 mm/5 1/2 in.  
tea/coffee spoon  
cuiller à café  
cuchara café  
cucchiaio caffè/té



■ 54.7278.6039  
■ 54.7278.6049

**Steakmesser\*\***

248 mm/9 3/4 in.  
steak knife\*\*  
couteau à steak\*\*  
cuchillo steak\*\*  
coltello da bistecca\*\*



■ 54.7209.6030  
■ 54.7209.6040

**Espresso- /  
Mokkalöffel**

110 mm/4 1/4 in.  
demi-tasse spoon  
cuiller à mocca  
cuchara moca  
cucchiaio moca



■ 54.7286.6039  
■ 54.7286.6049

**Obstmesser**

170 mm/6 3/4 in.  
fruit knife  
couteau à fruits  
cuchillo para fruta  
coltello da frutta



■ 54.7210.6030  
■ 54.7210.6040

**Vorspeisen- /  
Dessertlöffel**

163 mm/6 1/2 in.  
coffee/tea spoon, large  
cuiller à café/thé, grande  
cuchara à café/té, grande  
cucchiaio caffè/té, grande



■ 54.7289.6030  
■ 54.7289.6040

**Tassenlöffel**

181 mm/7 1/4 in.  
round bowl soup spoon  
cuiller à bouillon  
cuchara sopa  
cucchiaio da brodo



■ 54.7211.6030  
■ 54.7211.6040

**Gourmetlöffel**

203 mm/8 in.  
gourmet spoon  
cuiller à sauce  
cuchara salsa  
cucchiaio gourmet



VPE 12 Stk. / Unit 12 pcs.  
■ perfekte Versilberung /  
perfectly silverplated  
■ Cromargan®, poliert /  
stainless 18/10, polished  
\*\* Klingenstahl mit Wellenschliff /  
monobloc with serrated edge





■ **54 7200 6030**  
 perfekt versilbert  
 perfectly silverplated  
 chromage parfait  
 plateado perfecto  
 perfetta placcatura in argento

■ **54 7200 6040**  
 Cromargan®, poliert  
 Cromargan®, polished  
 Cromargan®, poli  
 Cromargan®, pulido  
 Cromargan®, lucido

Nordic besticht durch kühle Eleganz und eine außergewöhnliche Griff­länge. Umgeben von minimalistischem Interieur, fügt sich das klare Design stimmig ins Gesamtbild.

Nordic stands out thanks to its cool elegance and unusual handle length. In a minimalist interior setting, its clear design fits harmoniously into the overall look.

**NORDIC**  
 7200







Stark.  
Powerful.

Herausragend.  
Magnificent.

Schlank.  
Streamlined.

TELOS

■ 54.1801.6040

**Menuelöffel**

212 mm/8<sup>3</sup>/<sub>4</sub> in.  
table spoon  
cuiller de table  
cuchara mesa  
cucchiaio tavola



■ 54.1864.6040

**Kuchengabel**

159 mm/6<sup>2</sup>/<sub>4</sub> in.  
cake fork  
fourchette à gâteau  
tenedor lunch  
forchetta per dolce



■ 54.1802.6040

**Menuegabel**

211 mm/8<sup>3</sup>/<sub>4</sub> in.  
table fork  
fourchette de table  
tenedor mesa  
forchetta tavola



■ 54.1866.6049

**Brot- /  
Buttermesser\*\***

180 mm/7 in.  
bread/butter knife\*\*  
couteau de table\*\*  
cuchillo lunch\*\*  
coltello per dolce\*\*



■ 54.1803.6049

**Menuemesser\*\***

234 mm/9<sup>3</sup>/<sub>4</sub> in.  
table knife\*\*  
couteau de table\*\*  
cuchillo mesa\*\*  
coltello tavola cutinato\*\*



■ 54.1889.6040

**Tassenlöffel**

170 mm/6<sup>3</sup>/<sub>4</sub> in.  
round bowl soup spoon  
cuiller à bouillon  
cuchara sopa  
cucchiaio da brodo



■ 54.1804.6040

**Vorspeisenlöffel**

190 mm/7<sup>1</sup>/<sub>2</sub> in.  
dessert spoon  
cuiller à dessert  
cuchara postre  
cucchiaio frutta



■ 54.1805.6040

**Vorspeisengabel**

189 mm/7<sup>1</sup>/<sub>2</sub> in.  
dessert fork  
fourchette à dessert  
tenedor postre  
forchetta frutta



■ 54.1806.6049

**Vorspeisen-  
messer\*\***

210 mm/8<sup>3</sup>/<sub>4</sub> in.  
dessert knife\*\*  
couteau à dessert\*\*  
cuchillo postre\*\*  
coltello frutta\*\*



■ 54.1807.6040

**Kaffeelöffel**

136 mm/5<sup>3</sup>/<sub>4</sub> in.  
tea/coffee spoon  
cuiller à café  
cuchara café  
cucchiaio caffè/té



■ 54.1809.6040

**Espresso- /  
Mokkalöffel**

108 mm/4<sup>1</sup>/<sub>4</sub> in.  
demi-tasse spoon  
cuiller à mocca  
cuchara moca  
cucchiaio moca



■ 54.1810.6040

**Vorspeisen- /  
Dessertlöffel**

158 mm/6<sup>1</sup>/<sub>4</sub> in.  
coffee/tea spoon, large  
cuiller à café/thé, grande  
cuchara à café/té, grande  
cucchiaio caffè/té, grande



■ 54.1836.6040

**Fischmesser**

208 mm/8<sup>1</sup>/<sub>4</sub> in.  
fish knife  
couteau à poisson  
cuchillo pescado  
coltello pesce



VPE 12 Stk. / Unit 12 pcs.

■ Cromargan®, poliert /  
stainless 18/10, polished

\*\* Klingenstahl mit Wellenschliff /  
monobloc with serrated edge





■ **54 1800 6040**  
 Cromargan®, poliert  
 Cromargan®, polished  
 Cromargan®, poli  
 Cromargan®, pulido  
 Cromargan®, lucido

Telos entspricht den Bedürfnissen international orientierter Gastronomiekonzepte auf ganzer Linie. Dank der eingängigen Form avanciert das Modell zum zeitlosen Klassiker für die gehobene Gastronomie.

Telos satisfies the needs of international catering concepts in every way. With its recognizable shape, this model is advancing into a timeless classic for sophisticated dining.

**TELOS**  
 1800

**Schichtsalat**  
Dressing und gebratenen  
Pilzen

**Rinderkraftbrühe**  
mit Bärlauchnocken

**Original Wiener Schnitzel**  
mit Bratkartoffeln, Preiselbeeren und  
Saisonsalat

**Zwiebelrostbraten von der  
Rinderlende**  
an kräftiger Pfeffersauce mit Bärlauch-  
bratkartoffeln und Saisonsalat

**Panna Cotta**  
mit Rhabarberkompott

**Eisvariation**  
Gemischtes Eis mit Eierlikörsahne und  
frischen Früchten

*Guten  
Appetit*

























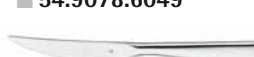

Energisch.  
Energetic.

Robust.  
Robust.

Ausgewogen.  
Balanced.

CASINO

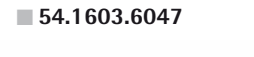
<p>■ 54.9001.6030 ■ 54.9001.6040</p> 	<p><b>Menuelöffel</b> 210 mm/8<sup>1</sup>/<sub>4</sub> in. table spoon cuiller de table cuchara mesa cucchiaio tavola</p>	<p>■ 54.9035.6030 ■ 54.9035.6040</p> 	<p><b>Fischgabel</b> 179 mm/7 in. fish fork fourchette à poisson tenedor pescado forchetta pesce</p>	<p>■ 54.1603.6039 ■ 54.1603.6049</p> 	<p><b>Menuemesser***</b> 236 mm/9<sup>1</sup>/<sub>4</sub> in. table knife*** couteau de table*** cuchillo mesa*** coltello tavola cutinato***</p>
<p>■ 54.9002.6030 ■ 54.9002.6040</p> 	<p><b>Menuegabel</b> 208 mm/8<sup>1</sup>/<sub>4</sub> in. table fork fourchette de table tenedor mesa forchetta tavola</p>	<p>■ 54.9036.6030 ■ 54.9036.6040</p> 	<p><b>Fischmesser</b> 201 mm/8 in. fish knife couteau à poisson cuchillo pescado coltello pesce</p>	<p>■ 54.1606.6037 ■ 54.1606.6047</p> 	<p><b>Vorspeisenmesser*</b> 217 mm/8<sup>1</sup>/<sub>2</sub> in. dessert knife* couteau à dessert* cuchillo postre* coltello frutta*</p>
<p>■ 54.9003.6039 ■ 54.9003.6049</p> 	<p><b>Menuemesser**</b> 234 mm/9<sup>1</sup>/<sub>4</sub> in. table knife** couteau de table** cuchillo mesa** coltello tavola cutinato**</p>	<p>■ 54.9040.6030 ■ 54.9040.6040</p> 	<p><b>Austerngabel</b> 149 mm/5<sup>7</sup>/<sub>8</sub> in. oyster fork fourchette à huîtres tenedor ostras forchetta per ostriche</p>	<p>■ 54.1606.6039 ■ 54.1606.6049</p> 	<p><b>Vorspeisenmesser***</b> 217 mm/8<sup>1</sup>/<sub>2</sub> in. dessert knife*** couteau à dessert*** cuchillo postre*** coltello frutta***</p>
<p>■ 54.9004.6030 ■ 54.9004.6040</p> 	<p><b>Vorspeisenlöffel</b> 190 mm/7<sup>1</sup>/<sub>2</sub> in. dessert spoon cuiller à dessert cuchara postre cucchiaio frutta</p>	<p>■ 54.9064.6030 ■ 54.9064.6040</p> 	<p><b>Kuchengabel</b> 158 mm/6<sup>1</sup>/<sub>4</sub> in. cake fork fourchette à gâteau tenedor lunch forchetta per dolce</p>		
<p>■ 54.9005.6030 ■ 54.9005.6040</p> 	<p><b>Vorspeisengabel</b> 188 mm/7<sup>1</sup>/<sub>2</sub> in. dessert fork fourchette à dessert tenedor postre forchetta frutta</p>	<p>■ 54.9066.6039 ■ 54.9066.6049</p> 	<p><b>Brot- / Buttermesser**</b> 170 mm/6<sup>3</sup>/<sub>4</sub> in. bread/butter knife** couteau de table** cuchillo lunch** coltello per dolce**</p>		
<p>■ 54.9006.6039 ■ 54.9006.6049</p> 	<p><b>Vorspeisenmesser**</b> 212 mm/8<sup>1</sup>/<sub>4</sub> in. dessert knife** couteau à dessert** cuchillo postre** coltello frutta**</p>	<p>■ 54.9072.6030 ■ 54.9072.6040</p> 	<p><b>Limolöffel</b> 220 mm/8<sup>3</sup>/<sub>4</sub> in. iced tea spoon cuiller à soda cuchara refresco cucchiaio bibita</p>		
<p>■ 54.9007.6030 ■ 54.9007.6040</p> 	<p><b>Kaffeelöffel</b> 134 mm/5<sup>1</sup>/<sub>4</sub> in. tea/coffee spoon cuiller à café cuchara café cucchiaio caffè/té</p>	<p>■ 54.9078.6039 ■ 54.9078.6049</p> 	<p><b>Steakmesser**</b> 234 mm/9<sup>1</sup>/<sub>4</sub> in. steak knife** couteau à steak** cuchillo steak** coltello da bistecca**</p>		
<p>■ 54.9009.6030 ■ 54.9009.6040</p> 	<p><b>Espresso- / Mokkalöffel</b> 108 mm/4<sup>1</sup>/<sub>4</sub> in. demi-tasse spoon cuiller à moca cuchara moca cucchiaio moca</p>	<p>■ 54.9089.6030 ■ 54.9089.6040</p> 	<p><b>Tassenlöffel</b> 168 mm/6<sup>1</sup>/<sub>2</sub> in. round bowl soup spoon cuiller à bouillon cuchara sopa cucchiaio da brodo</p>		
<p>■ 54.9010.6030 ■ 54.9010.6040</p> 	<p><b>Vorspeisen- / Dessertlöffel</b> 159 mm/6<sup>1</sup>/<sub>4</sub> in. coffee/tea spoon, large cuiller à café/thé, grande cuchara à café/té, grande cucchiaio caffè/té, grande</p>	<p>■ 54.9090.6039 ■ 54.9090.6049</p> 	<p><b>Pizzamesser</b> 234 mm/9<sup>1</sup>/<sub>4</sub> in. pizza knife couteau à pizza cuchillo pizza coltello da pizza</p>		
<p>■ 54.9011.6030 ■ 54.9011.6040</p> 	<p><b>Gourmetlöffel</b> 190 mm/7<sup>1</sup>/<sub>2</sub> in. gourmet spoon cuiller à sauce cuchara gourmet cucchiaio gourmet</p>	<p>■ 54.1603.6037 ■ 54.1603.6047</p> 	<p><b>Menuemesser*</b> 236 mm/9<sup>1</sup>/<sub>4</sub> in. table knife* couteau de table* cuchillo mesa* coltello tavola cutinato*</p>		

VPE 12 Stk. / Unit 12 pcs.

■ perfekte Versilberung /  
perfectly silverplated

■ Cromargan®, poliert /  
stainless 18/10, polished

\* Hohlheft mit Wellenschliff,  
steht auch auf Klinge /  
hollow-handle with serrated edge,  
standing on blade optional

\*\* Klingenstahl mit Wellenschliff /  
monobloc with serrated edge

\*\*\* Klingenstahl mit Wellenschliff,  
steht auch auf Klinge /  
monobloc with serrated edge,  
standing on blade optional





■ **54 9000 6030**  
 perfekt versilbert  
 perfectly silverplated  
 chromage parfait  
 plateado perfecto  
 perfetta placcatura in argento

■ **54 9000 6040**  
 Cromargan®, poliert  
 Cromargan®, polished  
 Cromargan®, poli  
 Cromargan®, pulido  
 Cromargan®, lucido

Casino wohnt ein klarer und zugleich eleganter Charakter inne. Die Kollektion wirkt wie aus einem Guss und ist prädestiniert als Begleiter stilsicherer Genusswelten.

Casino has a simple, yet elegant character. The collection forms a seamless whole and perfectly complements any stylish culinary environment.

**CASINO**  
 9000







Stimmig.  
Harmonious.

Prägnant.  
Distinctive.

Dezent.  
Discreet.

**SOLID**

■ 10.7901.6060  
■ 12.7901.6040

**Menuelöffel**

212 mm/8<sup>1</sup>/<sub>4</sub> in.  
table spoon  
cuiller de table  
cuchara mesa  
cucchiaio tavola



■ 10.7902.6060  
■ 12.7902.6040

**Menuegabel**

210 mm/8<sup>1</sup>/<sub>4</sub> in.  
table fork  
fourchette de table  
tenedor mesa  
forchetta tavola



■ 10.7903.6067  
■ 12.7903.6047

**Menuemesser\***

246 mm/9<sup>3</sup>/<sub>4</sub> in.  
table knife\*  
couteau de table\*  
cuchillo mesa\*  
coltello tavola cutinato\*



■ 10.7903.6069  
■ 12.7903.6049

**Menuemesser\*\***

239 mm/9<sup>1</sup>/<sub>2</sub> in.  
table knife\*\*  
couteau de table\*\*  
cuchillo mesa\*\*  
coltello tavola cutinato\*\*



■ 10.7904.6060  
■ 12.7904.6040

**Vorspeisenlöffel**

190 mm/7<sup>1</sup>/<sub>2</sub> in.  
dessert spoon  
cuiller à dessert  
cuchara postre  
cucchiaio frutta



■ 10.7905.6060  
■ 12.7905.6040

**Vorspeisengabel**

188 mm/7<sup>1</sup>/<sub>2</sub> in.  
dessert fork  
fourchette à dessert  
tenedor postre  
forchetta frutta



■ 10.7906.6067  
■ 12.7906.6047

**Vorspeisen-  
messer\***

220 mm/8<sup>3</sup>/<sub>4</sub> in.  
dessert knife\*  
couteau à dessert\*  
cuchillo postre\*  
coltello frutta\*



■ 10.7906.6069  
■ 12.7906.6049

**Vorspeisen-  
messer\*\***

214 mm/8<sup>1</sup>/<sub>2</sub> in.  
dessert knife\*\*  
couteau à dessert\*\*  
cuchillo postre\*\*  
coltello frutta\*\*



■ 10.7907.6060  
■ 12.7907.6040

**Kaffeelöffel**

136 mm/5<sup>1</sup>/<sub>4</sub> in.  
tea/coffee spoon  
cuiller à café  
cuchara café  
cucchiaio caffè/té



■ 10.7909.6060  
■ 12.7909.6040

**Espresso- /  
Mokkalöffel**

108 mm/4<sup>1</sup>/<sub>4</sub> in.  
demi-tasse spoon  
cuiller à mocca  
cuchara moca  
cucchiaio moca



■ 10.7910.6060  
■ 12.7910.6040

**Vorspeisen- /  
Dessertlöffel**

159 mm/6<sup>1</sup>/<sub>4</sub> in.  
coffee/tea spoon, large  
cuiller à café/thé, grande  
cuchara à café/té, grande  
cucchiaio caffè/té, grande



■ 10.7911.6060  
■ 12.7911.6040

**Gourmetlöffel**

190 mm/7<sup>1</sup>/<sub>2</sub> in.  
gourmet spoon  
cuiller à sauce  
cuchara gourmet  
cucchiaio gourmet



■ 10.7935.6062  
■ 12.7935.6042

**Fischgabel**

188 mm/7<sup>1</sup>/<sub>2</sub> in.  
fish fork  
fourchette à poisson  
tenedor pescado  
forchetta pesce



■ 10.7935.6063  
■ 12.7935.6043

**Fischmesser**

209 mm/8<sup>1</sup>/<sub>4</sub> in.  
fish knife  
couteau à poisson  
cuchillo pescado  
coltello pesce



■ 10.7940.6060  
■ 12.7940.6040

**Austerngabel**

149 mm/5<sup>3</sup>/<sub>4</sub> in.  
oyster fork  
fourchette à huîtres  
tenedor ostras  
forchetta per ostriche



■ 10.7964.6060  
■ 12.7964.6040

**Kuchengabel**

160 mm/6<sup>1</sup>/<sub>4</sub> in.  
cake fork  
fourchette à gâteau  
tenedor lunch  
forchetta per dolce



■ 10.7966.6069  
■ 12.7966.6049

**Brot- /  
Buttermesser\*\***

170 mm/6<sup>3</sup>/<sub>4</sub> in.  
bread/butter knife\*\*  
couteau de table\*\*  
cuchillo lunch\*\*  
coltello per dolce\*\*



■ 10.7972.6060  
■ 12.7972.6040

**Limolöffel**

220 mm/8<sup>3</sup>/<sub>4</sub> in.  
iced tea spoon  
cuiller à soda  
cuchara refresco  
cucchiaio bibita



■ 10.7978.6069  
■ 12.7978.6049

**Steakmesser\*\***

235 mm/9<sup>1</sup>/<sub>4</sub> in.  
steak knife\*\*  
couteau à steak\*\*  
cuchillo steak\*\*  
coltello da bistecca\*\*



■ 10.7989.6060  
■ 12.7989.6040

**Tassenlöffel**

170 mm/6<sup>3</sup>/<sub>4</sub> in.  
round bowl soup spoon  
cuiller à bouillon  
cuchara sopa  
cucchiaio da brodo



VPE 12 Stk. / Unit 12 pcs.

■ perfekte Versilberung /  
perfectly silverplated

■ Cromargan®, poliert /  
stainless 18/10, polished

\* Hohlheft mit Wellenschliff /  
hollow-handled with serrated edge

\*\* Klingenstahl mit Wellenschliff /  
monobloc with serrated edge





■ **10 7900 6060**  
 perfekt versilbert  
 perfectly silverplated  
 chromage parfait  
 plateado perfecto  
 perfetta placcatura in argento

■ **12 7900 6040**  
 Cromargan®, poliert  
 Cromargan®, polished  
 Cromargan®, poli  
 Cromargan®, pulido  
 Cromargan®, lucido

Solid betont mit seiner gediegenen und dennoch nicht alltäglichen Optik verschiedene Inszenierungen zünftiger Gastronomiekonzepte. Mit kräftigen Formen und langen Zinken ist das Modell bestens ausbalanciert.

Solid has a dignified, yet extraordinary appearance and can complement a range of different looks for authentic catering concepts. With its powerful forms and long tines, this collection is perfectly balanced.

**SOLID**  
 7900



# MENU

**Gemischter Salat**  
mit Bärlauchdressing und  
Pilzen

**Rinderkraut**  
mit Bärlauch

**Originaler Schnitzel**  
mit Bratöl, Preiselbeeren und  
Sensalat

**Rinderk**  
saftiger Pfeffersauce  
bratkartoffeln und  
Salat

**Panada**  
mit Rindfleisch  
kompote

**Variation**  
Gerichte mit Eierlikörsahne und  
frischen Früchten





Stylisch.  
Stylish.

Endlos.  
Infinite.

Schlicht.  
Simple.

BASE

■ 12.2301.6040

**Menuelöffel**

199 mm/7<sup>7</sup>/<sub>8</sub> in.  
table spoon  
cuiller de table  
cuchara mesa  
cucchiaio tavola



■ 12.2366.6049

**Brot- /  
Buttermesser\*\***

177 mm/7 in.  
bread/butter knife\*\*  
couteau de table\*\*  
cuchillo lunch\*\*  
coltello per dolce\*\*



■ 12.2302.6040

**Menuegabel**

197 mm/7<sup>7</sup>/<sub>8</sub> in.  
table fork  
fourchette de table  
tenedor mesa  
forchetta tavola



■ 12.2389.6040

**Tassenlöffel**

166 mm/6<sup>1</sup>/<sub>2</sub> in.  
round bowl soup spoon  
cuiller à bouillon  
cuchara sopa  
cucchiaio da brodo



■ 12.2303.6049

**Menuemesser\*\***

226 mm/9 in.  
table knife\*\*  
couteau de table\*\*  
cuchillo mesa\*\*  
coltello tavola cutinato\*\*



■ 12.2304.6040

**Vorspeisenlöffel**

187 mm/7<sup>1</sup>/<sub>4</sub> in.  
dessert spoon  
cuiller à dessert  
cuchara postre  
cucchiaio frutta



■ 12.2305.6040

**Vorspeisengabel**

185 mm/7<sup>1</sup>/<sub>4</sub> in.  
dessert fork  
fourchette à dessert  
tenedor postre  
forchetta frutta



■ 12.2306.6049

**Vorspeisen-  
messer\*\***

213 mm/8<sup>1</sup>/<sub>2</sub> in.  
dessert knife\*\*  
couteau à dessert\*\*  
cuchillo postre\*\*  
coltello frutta\*\*



■ 12.2307.6040

**Kaffeelöffel**

132 mm/5<sup>1</sup>/<sub>4</sub> in.  
tea/coffee spoon  
cuiller à café  
cuchara café  
cucchiaio caffè/té



■ 12.2309.6040

**Espresso- /  
Mokkalöffel**

108 mm/4<sup>1</sup>/<sub>4</sub> in.  
demi-tasse spoon  
cuiller à mocca  
cuchara moca  
cucchiaio moca



■ 12.2310.6040

**Vorspeisen- /  
Dessertlöffel**

156 mm/6<sup>1</sup>/<sub>4</sub> in.  
coffee/tea spoon, large  
cuiller à café/thé, grande  
cuchara à café/té, grande  
cucchiaio caffè/té, grande



■ 12.2364.6040

**Kuchengabel**

157 mm/6<sup>1</sup>/<sub>4</sub> in.  
cake fork  
fourchette à gâteau  
tenedor lunch  
forchetta per dolce



VPE 12 Stk. / Unit 12 pcs.

■ Cromargan®, poliert /  
stainless 18/10, polished

\*\* Klingenstahl mit Wellenschliff /  
monobloc with serrated edge





■ 12 2300 6040  
 Cromargan®, poliert  
 Cromargan®, polished  
 Cromargan®, poli  
 Cromargan®, pulido  
 Cromargan®, lucido

Base ist für die Ewigkeit gemacht. Mit seiner schlichten Formgebung flankiert das Besteck die unterschiedlichsten Formen und Farben an Porzellan sowie Accessoires.

Base is never going to be out of fashion. With its simple forms, this cutlery complements porcelain and accessories of all shapes and colors.

**BASE**  
 2300







Direkt.  
Straight.

Markant.  
Striking.

Modern.  
Modern.

UNIC

■ 10.5301.6060  
■ 12.5301.6040

**Menuelöffel**

215 mm/8½ in.  
table spoon  
cuiller de table  
cuchara mesa  
cucchiaio tavola



■ 10.5302.6060  
■ 12.5302.6040

**Menuegabel**

214 mm/8½ in.  
table fork  
fourchette de table  
tenedor mesa  
forchetta tavola



■ 10.5303.6061  
■ 12.5303.6041

**Menuemesser\*\*\***

237 mm/9½ in.  
table knife\*\*\*  
couteau de table\*\*\*  
cuchillo mesa\*\*\*  
coltello tavola\*\*\*



■ 10.5303.6067  
■ 12.5303.6047

**Menuemesser\***

233 mm/9¼ in.  
table knife\*  
couteau de table\*  
cuchillo mesa\*  
coltello tavola cutinato\*



■ 10.5303.6069  
■ 12.5303.6049

**Menuemesser\*\***

236 mm/9¼ in.  
table knife\*\*  
couteau de table\*\*  
cuchillo mesa\*\*  
coltello tavola\*\*



■ 10.5304.6060  
■ 12.5304.6040

**Vorspeisenlöffel**

196 mm/7¾ in.  
dessert spoon  
cuiller à dessert  
cuchara postre  
cucchiaio frutta



■ 10.5305.6060  
■ 12.5305.6040

**Vorspeisengabel**

195 mm/7¾ in.  
dessert fork  
fourchette à dessert  
tenedor postre  
forchetta frutta



■ 10.5306.6061  
■ 12.5306.6041

**Vorspeisen-  
messer\*\*\***

216 mm/8½ in.  
dessert knife\*\*\*  
couteau à dessert\*\*\*  
cuchillo postre\*\*\*  
coltello frutta\*\*\*



■ 10.5306.6067  
■ 12.5306.6047

**Vorspeisen-  
messer\***

212 mm/8½ in.  
dessert knife\*  
couteau à dessert\*  
cuchillo postre\*  
coltello frutta\*



■ 10.5306.6069  
■ 12.5306.6049

**Vorspeisen-  
messer\*\***

215 mm/8½ in.  
dessert knife\*\*  
couteau à dessert\*\*  
cuchillo postre\*\*  
coltello frutta\*\*



■ 10.5307.6060  
■ 12.5307.6040

**Kaffeelöffel**

136 mm/5¼ in.  
tea/coffee spoon  
cuiller à café  
cuchara café  
cucchiaio caffè/té



■ 10.5309.6060  
■ 12.5309.6040

**Espresso- /  
Mokkalöffel**

108 mm/4¼ in.  
demi-tasse spoon  
cuiller à moca  
cuchara moca  
cucchiaio moca



■ 10.5310.6060  
■ 12.5310.6040

**Vorspeisen- /  
Dessertlöffel**

156 mm/6¼ in.  
coffee/tea spoon, large  
cuiller à café/thé, grande  
cuchara à café/té, grande  
cucchiaio caffè/té, grande



■ 10.5311.6060  
■ 12.5311.6040

**Gourmetlöffel**

196 mm/7¾ in.  
gourmet spoon  
cuiller à sauce  
cuchara gourmet  
cucchiaio gourmet



■ 10.5335.6061  
■ 12.5335.6041

**Fischmesser\*\*\*\***

216 mm/8½ in.  
fish knife\*\*\*\*  
couteau à poisson\*\*\*\*  
cuchillo pescado\*\*\*\*  
coltello pesce\*\*\*\*



■ 10.5335.6062  
■ 12.5335.6042

**Fischgabel**

190 mm/7½ in.  
fish fork  
fourchette à poisson  
tenedor pescado  
forchetta pesce



■ 10.5335.6063  
■ 12.5335.6043

**Fischmesser**

215 mm/8½ in.  
fish knife  
couteau à poisson  
cuchillo pescado  
coltello pesce



■ 10.5340.6060  
■ 12.5340.6040

**Austerngabel**

149 mm/5¾ in.  
oyster fork  
fourchette à huîtres  
tenedor ostras  
forchetta per ostriche



■ 10.5364.6060  
■ 12.5364.6040

**Kuchengabel**

157 mm/6¼ in.  
cake fork  
fourchette à gâteau  
tenedor lunch  
forchetta per dolce



■ 10.5366.6061  
■ 12.5366.6041

**Brot- /  
Buttermesser\*\*\***

170 mm/6¾ in.  
bread/butter knife\*\*\*  
couteau de table\*\*\*  
cuchillo lunch\*\*  
coltello per dolce\*\*\*



■ 10.5366.6069  
■ 12.5366.6049

**Brot- /  
Buttermesser\*\***

170 mm/6¾ in.  
bread/butter knife\*\*  
couteau de table\*\*  
cuchillo mesa\*\*  
coltello per dolce\*\*



■ 10.5372.6060  
■ 12.5372.6040

**Limolöffel**

220 mm/8½ in.  
iced tea spoon  
cuiller à soda  
cuchara refresco  
cucchiaio bibita



■ 10.5378.6069  
■ 12.5378.6049

**Steakmesser\*\***

239 mm/9½ in.  
steak knife\*\*  
couteau à steak\*\*  
cuchillo steak\*\*  
coltello da bistecca\*\*



■ 10.5389.6060  
■ 12.5389.6040

**Tassenlöffel**

174 mm/6¾ in.  
round bowl soup spoon  
cuiller à bouillon  
cuchara sopa  
cucchiaio da brodo



VPE 12 Stk. / Unit 12 pcs.

- perfekte Versilberung / perfectly silverplated
- Cromargan®, poliert / stainless 18/10, polished

\* Hohlheft mit Wellenschliff / hollow-handled with serrated edge

\*\* Klingenstahl mit Wellenschliff / monobloc with serrated edge

\*\*\* Klingenstahl mit Wellenschliff, steht auch auf Klinge / monobloc with serrated edge, standing on blade optional

\*\*\*\* Klingenstahl, steht auf Klinge / monobloc, standing on blade optional





■ **10 5300 6060**  
 perfekt versilbert  
 perfectly silverplated  
 chromage parfait  
 plateado perfecto  
 perfetta placcatura in argento

■ **12 5300 6040**  
 Cromargan®, poliert  
 Cromargan®, polished  
 Cromargan®, poli  
 Cromargan®, pulido  
 Cromargan®, lucido

Unic macht einen klassischen Eindruck – und das trotz der designorientierten Silhouette. Die streng parallel verlaufende Linienführung passt zu jeglicher Art von modernen Tafeln.

Unic makes a classic impression, despite its design-oriented silhouette. Its strong parallel lines fit perfectly with any modern table design.

**UNIC**  
**5300**





haube

ektail  
em Dill





Harmonisch.  
Harmonious.

Klassisch.  
Classic.

Vielseitig.  
Versatile.

**GASTRO**

■ 12.0801.6040

**Menuelöffel**

195 mm/7<sup>3</sup>/<sub>4</sub> in.  
table spoon  
cuiller de table  
cuchara mesa  
cucchiaio tavola



■ 12.0810.6040

**Vorspeisen- /  
Dessertlöffel**

156 mm/6<sup>1</sup>/<sub>4</sub> in.  
coffee/tea spoon, large  
cuiller à café/thé, grande  
cuchara lunch  
cucchiaio caffè/té grande



■ 12.0802.6040

**Menuegabel**

193 mm/7<sup>1</sup>/<sub>2</sub> in.  
table fork  
fourchette de table  
tenedor mesa  
forchetta tavola



■ 12.0835.6042

**Fischgabel**

178 mm/7 in.  
fish fork  
fourchette à poisson  
tenedor pescado  
forchetta pesce



■ 12.0803.6047

**Menuemesser\***

209 mm/8<sup>1</sup>/<sub>2</sub> in.  
table knife\*  
couteau de table\*  
cuchillo mesa\*  
coltello tavola cutinato\*



■ 12.0835.6043

**Fischmesser**

205 mm/8 in.  
fish knife  
couteau à poisson  
cuchillo pescado  
coltello pesce



■ 12.0803.6049

**Menuemesser\*\***

209 mm/8<sup>1</sup>/<sub>2</sub> in.  
table knife\*\*  
couteau de table\*\*  
cuchillo mesa\*\*  
coltello tavola cutinato\*\*



■ 12.0864.6040

**Kuchengabel**

157 mm/6<sup>1</sup>/<sub>4</sub> in.  
cake fork  
fourchette à gâteau  
tenedor lunch  
forchetta per dolce



■ 12.0804.6040

**Vorspeisenlöffel**

182 mm/7<sup>1</sup>/<sub>2</sub> in.  
dessert spoon  
cuiller à dessert  
cuchara postre  
cucchiaio frutta



■ 12.0866.6049

**Brot- /  
Buttermesser\*\***

168 mm/6<sup>1</sup>/<sub>2</sub> in.  
bread/butter knife\*\*  
couteau de table\*\*  
cuchillo lunch\*\*  
coltello per dolce\*\*



■ 12.0805.6040

**Vorspeisengabel**

180 mm/7 in.  
dessert fork  
fourchette à dessert  
tenedor postre  
forchetta frutta



■ 12.0872.6040

**Limolöffel**

220 mm/8<sup>3</sup>/<sub>4</sub> in.  
iced tea spoon  
cuiller à soda  
cuchara refresco  
cucchiaio bibita



■ 12.0806.6047

**Vorspeisen-  
messer\***

195 mm/7<sup>3</sup>/<sub>4</sub> in.  
dessert knife\*  
couteau à dessert\*  
cuchillo postre\*  
coltello frutta\*



■ 12.0878.6047

**Steakmesser\***

232 mm/9<sup>1</sup>/<sub>4</sub> in.  
steak knife\*  
couteau à steak\*  
cuchillo steak\*  
coltello da bistecca\*



■ 12.0806.6049

**Vorspeisen-  
messer\*\***

195 mm/7<sup>3</sup>/<sub>4</sub> in.  
dessert knife\*\*  
couteau à dessert\*\*  
cuchillo postre\*\*  
coltello frutta\*\*



■ 12.0878.6049

**Steakmesser\*\***

232 mm/9<sup>1</sup>/<sub>4</sub> in.  
steak knife\*\*  
couteau à steak\*\*  
cuchillo steak\*\*  
coltello da bistecca\*\*



■ 12.0807.6040

**Kaffeelöffel**

132 mm/5<sup>1</sup>/<sub>4</sub> in.  
tea/coffee spoon  
cuiller à café  
cuchara café  
cucchiaio caffè/té



■ 12.0889.6040

**Tassenlöffel**

168 mm/6<sup>1</sup>/<sub>2</sub> in.  
round bowl soup spoon  
cuiller à bouillon  
cuchara sopa  
cucchiaio da brodo



■ 12.0809.6040

**Espresso- /  
Mokkalöffel**

108 mm/4<sup>1</sup>/<sub>4</sub> in.  
demi-tasse spoon  
cuiller à mocca  
cuchara moca  
cucchiaio moca



VPE 12 Stk. / Unit 12 pcs.

- Cromargan®, poliert / stainless 18/10, polished
- \* Hohlheft mit Wellenschliff / hollow-handled with serrated edge
- \*\* Klingenstahl mit Wellenschliff / monobloc with serrated edge





■ 12 0800 6040  
 Cromargan®, poliert  
 Cromargan®, polished  
 Cromargan®, poli  
 Cromargan®, pulido  
 Cromargan®, lucido

Gastro ist dank seiner dezenten und gleichzeitig eleganten Silhouette wie geschaffen für originelle Gastro-Konzepte. Drapiert auf kariertem Tischwäsche oder einfachen Holztischen entfaltet sich der typische Flair.

With its understated, yet elegant silhouette, Gastro is the ideal choice for original catering concepts. Bring out the best in this cutlery by laying it out on checked table linens or simple wooden tables.

**GASTRO**  
 0800







Geschmeidig.  
Smooth.

Vertraut.  
Familiar.

Etabliert.  
Established.

**SIGNUM**

■ 10.1901.6060

■ 12.1901.6040

**Menuelöffel**

212 mm/8<sup>1</sup>/<sub>2</sub> in.  
table spoon  
cuiller de table  
cuchara mesa  
cucchiaio tavola



■ 10.1902.6060

■ 12.1902.6040

**Menuegabel**

210 mm/8<sup>1</sup>/<sub>2</sub> in.  
table fork  
fourchette de table  
tenedor mesa  
forchetta tavola



■ 10.1903.6067

■ 12.1903.6047

**Menuemesser\***

239 mm/9<sup>1</sup>/<sub>2</sub> in.  
table knife\*  
couteau de table\*  
cuchillo mesa\*  
coltello tavola cutinato\*



■ 10.1903.6069

■ 12.1903.6049

**Menuemesser\*\***

238 mm/9<sup>1</sup>/<sub>2</sub> in.  
table knife\*\*  
couteau de table\*\*  
cuchillo mesa\*\*  
coltello tavola cutinato\*\*



■ 10.1904.6060

■ 12.1904.6040

**Vorspeisenlöffel**

190 mm/7<sup>1</sup>/<sub>2</sub> in.  
dessert spoon  
cuiller à dessert  
cuchara postre  
cucchiaio frutta



■ 10.1905.6060

■ 12.1905.6040

**Vorspeisengabel**

188 mm/7<sup>1</sup>/<sub>2</sub> in.  
dessert fork  
fourchette à dessert  
tenedor postre  
forchetta frutta



■ 10.1906.6067

■ 12.1906.6047

**Vorspeisen-  
messer\***

214 mm/8<sup>1</sup>/<sub>2</sub> in.  
dessert knife\*  
couteau à dessert\*  
cuchillo postre\*  
coltello frutta\*



■ 10.1906.6069

■ 12.1906.6049

**Vorspeisen-  
messer\*\***

213 mm/8<sup>1</sup>/<sub>2</sub> in.  
dessert knife\*\*  
couteau à dessert\*\*  
cuchillo postre\*\*  
coltello frutta\*\*



■ 10.1907.6060

■ 12.1907.6040

**Kaffeelöffel**

136 mm/5<sup>1</sup>/<sub>2</sub> in.  
tea/coffee spoon  
cuiller à café  
cuchara café  
cucchiaio caffè/té



■ 10.1909.6060

■ 12.1909.6040

**Espresso- /  
Mokkalöffel**

108 mm/4<sup>1</sup>/<sub>2</sub> in.  
demi-tasse spoon  
cuiller à mocca  
cuchara moca  
cucchiaio moca



■ 10.1910.6060

■ 12.1910.6040

**Vorspeisen- /  
Dessertlöffel**

156 mm/6<sup>1</sup>/<sub>4</sub> in.  
coffee/tea spoon, large  
cuiller à café/thé grande  
cuchara à café/té, grande  
cucchiaio caffè/té, grande



■ 10.1911.6060

■ 12.1911.6040

**Gourmetlöffel**

190 mm/7<sup>1</sup>/<sub>2</sub> in.  
gourmet spoon  
cuiller à sauce  
cuchara gourmet  
cucchiaio gourmet



■ 10.1916.6060

■ 12.1916.6040

**Gemüselöffel**

237 mm/9<sup>1</sup>/<sub>2</sub> in.  
vegetable serving spoon  
cuiller à légumes  
cucharón legumbres  
cucchiaione servire



■ 10.1935.6062

■ 12.1935.6042

**Fischgabel**

184 mm/7<sup>1</sup>/<sub>4</sub> in.  
fish fork  
fourchette à poisson  
tenedor pescado  
forchetta pesce



■ 10.1935.6063

■ 12.1935.6043

**Fischmesser**

206 mm/8 in.  
fish knife  
couteau à poisson  
cuchillo pescado  
coltello pesce



■ 10.1940.6060

■ 12.1940.6040

**Austerngabel**

149 mm/5<sup>3</sup>/<sub>4</sub> in.  
oyster fork  
fourchette à huîtres  
tenedor ostras  
forchetta per ostriche



■ 10.1964.6060

■ 12.1964.6040

**Kuchengabel**

157 mm/6<sup>1</sup>/<sub>4</sub> in.  
cake fork  
fourchette à gâteau  
tenedor lunch  
forchetta per dolce



■ 10.1966.6069

■ 12.1966.6049

**Brot- /  
Buttermesser\*\***

170 mm/6<sup>3</sup>/<sub>4</sub> in.  
bread/butter knife\*\*  
couteau de table\*\*  
cuchillo mesa\*\*  
coltello per dolce\*\*



■ 10.1972.6060

■ 12.1972.6040

**Limolöffel**

220 mm/8<sup>3</sup>/<sub>4</sub> in.  
iced tea spoon  
cuiller à soda  
cuchara refresco  
cucchiaio bibita



■ 10.1978.6069

■ 12.1978.6049

**Steakmesser\*\***

239 mm/9<sup>1</sup>/<sub>2</sub> in.  
steak knife\*\*  
couteau à steak\*\*  
cuchillo steak\*\*  
coltello da bistecca\*\*



■ 10.1986.6069

■ 12.1986.6049

**Obstmesser**

170 mm/6<sup>3</sup>/<sub>4</sub> in.  
fruit knife  
couteau à fruits  
cuchillo para fruta  
coltello da frutta



■ 10.1989.6060

■ 12.1989.6040

**Tassenlöffel**

170 mm/6<sup>3</sup>/<sub>4</sub> in.  
round bowl soup spoon  
cuiller à bouillon  
cuchara sopa  
cucchiaio da brodo



■ 10.1990.6069

■ 12.1990.6049

**Pizzamesser**

239 mm/9<sup>1</sup>/<sub>2</sub> in.  
pizza knife  
couteau à pizza  
cuchillo pizza  
coltello da pizza



VPE 12 Stk. / Unit 12 pcs.

■ perfekte Versilberung /  
perfectly silverplated

■ Cromargan®, poliert /  
stainless 18/10, polished

\* Hohlheft mit Wellenschliff /  
hollow-handled with serrated edge

\*\* Klingenstahl mit Wellenschliff /  
monobloc with serrated edge





■ **10 1900 6060**  
 perfekt versilbert  
 perfectly silverplated  
 chromage parfait  
 plateado perfecto  
 perfetta placcatura in argento

■ **12 1900 6040**  
 Cromargan®, poliert  
 Cromargan®, polished  
 Cromargan®, poli  
 Cromargan®, pulido  
 Cromargan®, lucido

Signum vereint die traditionelle Rundstilform mit einer klaren Linienführung – und sorgt für ein modernes und zugleich vertrautes Tischambiente in ganz unterschiedlichen Interieur-Stilen.

Signum combines the traditional rounded handle with clear lines, helping to create a modern, yet familiar table ambience in all kinds of interiors.

**SIGNUM**  
 1900







Fein.  
Delicate.

Schwungvoll.  
Curvy.

Dekorativ.  
Decorative.

CONTOUR

■ 10.0201.6060  
 ■ 12.0201.6040  
**Menuelöffel**  
 200 mm/8 in.  
 table spoon  
 cuiller de table  
 cuchara mesa  
 cucchiaio tavola



■ 10.0210.6060  
 ■ 12.0210.6040  
**Vorspeisen- /  
 Dessertlöffel**  
 156 mm/6 1/4 in.  
 coffee/tea spoon, large  
 cuiller à café/thé, grande  
 cuchara à café/té, grande  
 cucchiaio caffè/té, grande



■ 10.0202.6060  
 ■ 12.0202.6040  
**Menuegabel**  
 203 mm/8 in.  
 table fork  
 fourchette de table  
 tenedor mesa  
 forchetta tavola



■ 10.0211.6060  
 ■ 12.0211.6040  
**Gourmetlöffel**  
 190 mm/7 1/2 in.  
 gourmet spoon  
 cuiller à sauce  
 cuchara gourmet  
 cucchiaio gourmet



■ 10.0203.6067  
 ■ 12.0203.6047  
**Menuemesser\***  
 230 mm/9 in.  
 table knife\*  
 couteau de table\*  
 cuchillo mesa\*  
 coltello tavola cutinato\*



■ 10.0235.6062  
 ■ 12.0235.6042  
**Fischgabel**  
 174 mm/6 7/8 in.  
 fish fork  
 fourchette à poisson  
 tenedor pescado  
 forchetta pesce



■ 10.0203.6069  
 ■ 12.0203.6049  
**Menuemesser\*\***  
 235 mm/9 1/4 in.  
 table knife\*\*  
 couteau de table\*\*  
 cuchillo mesa\*\*  
 coltello tavola\*\*



■ 10.0235.6063  
 ■ 12.0235.6043  
**Fischmesser**  
 204 mm/8 in.  
 fish knife  
 couteau à poisson  
 cuchillo pescado  
 coltello pesce



■ 10.0204.6060  
 ■ 12.0204.6040  
**Vorspeisenlöffel**  
 182 mm/7 1/4 in.  
 dessert spoon  
 cuiller à dessert  
 cuchara postre  
 cucchiaio frutta



■ 10.0240.6060  
 ■ 12.0240.6040  
**Austerngabel**  
 136 mm/5 1/4 in.  
 oyster fork  
 fourchette à huîtres  
 tenedor ostras  
 forchetta per ostriche



■ 10.0205.6060  
 ■ 12.0205.6040  
**Vorspeisengabel**  
 185 mm/7 1/4 in.  
 dessert fork  
 fourchette à dessert  
 tenedor postre  
 forchetta frutta



■ 10.0264.6060  
 ■ 12.0264.6040  
**Kuchengabel**  
 152 mm/6 in.  
 cake fork  
 fourchette à gâteau  
 tenedor lunch  
 forchetta per dolce



■ 10.0206.6067  
 ■ 12.0206.6047  
**Vorspeisen-  
 messer\***  
 211 mm/8 1/4 in.  
 dessert knife\*  
 couteau à dessert\*  
 cuchillo postre\*  
 coltello frutta\*



■ 10.0266.6069  
 ■ 12.0266.6049  
**Brot- /  
 Buttermesser\*\***  
 170 mm/6 7/8 in.  
 bread/butter knife\*\*  
 couteau de table\*\*  
 cuchillo lunch\*\*  
 coltello per dolce\*\*



■ 10.0206.6069  
 ■ 12.0206.6049  
**Vorspeisen-  
 messer\*\***  
 211 mm/8 1/4 in.  
 dessert knife\*\*  
 couteau à dessert\*\*  
 cuchillo postre\*\*  
 coltello frutta\*\*



■ 10.0272.6060  
 ■ 12.0272.6040  
**Limolöffel**  
 220 mm/8 3/4 in.  
 iced tea spoon  
 cuiller à soda  
 cuchara refresco  
 cucchiaio bibita



■ 10.0207.6060  
 ■ 12.0207.6040  
**Kaffeelöffel**  
 132 mm/5 1/4 in.  
 tea/coffee spoon  
 cuiller à café  
 cuchara café  
 cucchiaio caffè/té



■ 12.0278.6049  
**Steakmesser\*\***  
 225 mm/8 7/8 in.  
 steak knife\*\*  
 couteau à steak\*\*  
 cuchillo steak\*\*  
 coltello da bistecca\*\*



■ 10.0209.6060  
 ■ 12.0209.6040  
**Espresso- /  
 Mokkalöffel**  
 108 mm/4 1/4 in.  
 demi-tasse spoon  
 cuiller à mocca  
 cuchara moca  
 cucchiaio moca



■ 10.0289.6060  
 ■ 12.0289.6040  
**Tassenlöffel**  
 169 mm/6 7/8 in.  
 round bowl soup spoon  
 cuiller à bouillon  
 cuchara sopa  
 cucchiaio da brodo



VPE 12 Stk. / Unit 12 pcs.

■ perfekte Versilberung /  
 perfectly silverplated

■ Cromargan®, poliert /  
 stainless 18/10, polished

\* Hohlheft mit Wellenschliff /  
 hollow-handled with serrated edge

\*\* Klingenstahl mit Wellenschliff /  
 monobloc with serrated edge





■ **10 0200 6060**  
 perfekt versilbert  
 perfectly silverplated  
 chromage parfait  
 plateado perfecto  
 perfetta placcatura in argento

■ **12 0200 6040**  
 Cromargan®, poliert  
 Cromargan®, polished  
 Cromargan®, poli  
 Cromargan®, pulido  
 Cromargan®, lucido

Contour greift mit feinen Prägungen und tropfenförmigen Griffen traditionelle Besteckmuster auf moderne Weise auf. Die schwungvolle Linienführung fügt sich harmonisch in eine lockere Atmosphäre ein.

With its fine stamping and drop-shaped handles, Contour is a modern take on traditional cutlery designs. Its flowing lines perfectly suit a more relaxed atmosphere.

**CONTOUR**  
 0200







Wandelbar.  
Versatile.

Zeitlos.  
Timeless.

Geradlinig.  
Straightforward.

**BISTRO**

■ 01.0401.6060  
 ■ 11.0401.6040  
**Menuelöffel**  
 203 mm/8 in.  
 table spoon  
 cuiller de table  
 cuchara mesa  
 cucchiaio tavola



■ 01.0402.6060  
 ■ 11.0402.6040  
**Menuegabel**  
 201 mm/8 in.  
 table fork  
 fourchette de table  
 tenedor mesa  
 forchetta tavola



■ 01.0403.6067  
 ■ 11.0403.6047  
**Menuemesser\***  
 230 mm/9 in.  
 table knife\*  
 couteau de table\*  
 cuchillo mesa\*  
 coltello tavola cutinato\*



■ 01.0403.6069  
 ■ 11.0403.6049  
**Menuemesser\*\***  
 227 mm/9 in.  
 table knife\*\*  
 couteau de table\*\*  
 cuchillo mesa\*\*  
 coltello tavola cutinato\*\*



■ 01.0404.6060  
 ■ 11.0404.6040  
**Vorspeisenlöffel**  
 183 mm/7 1/4 in.  
 dessert spoon  
 cuiller à dessert  
 cuchara postre  
 cucchiaio frutta



■ 01.0405.6060  
 ■ 11.0405.6040  
**Vorspeisengabel**  
 181 mm/7 in.  
 dessert fork  
 fourchette à dessert  
 tenedor postre  
 forchetta frutta



■ 01.0406.6067  
 ■ 11.0406.6047  
**Vorspeisen-  
 messer\***  
 209 mm/8 1/4 in.  
 dessert knife\*  
 couteau à dessert\*  
 cuchillo postre\*  
 coltello frutta\*



■ 01.0406.6069  
 ■ 11.0406.6049  
**Vorspeisen-  
 messer\*\***  
 205 mm/8 in.  
 dessert knife\*\*  
 couteau à dessert\*\*  
 cuchillo postre\*\*  
 coltello frutta\*\*



■ 01.0407.6060  
 ■ 11.0407.6040  
**Kaffeelöffel**  
 132 mm/5 1/4 in.  
 tea/coffee spoon  
 cuiller à café  
 cuchara café  
 cucchiaio caffè/té



■ 01.0409.6060  
 ■ 11.0409.6040  
**Espresso- /  
 Mokkalöffel**  
 108 mm/4 1/4 in.  
 demi-tasse spoon  
 cuiller à mocca  
 cuchara moca  
 cucchiaio moca



■ 01.0410.6060  
 ■ 11.0410.6040  
**Vorspeisen- /  
 Dessertlöffel**  
 156 mm/6 1/4 in.  
 coffee/tea spoon, large  
 cuiller à café/thé, grande  
 cuchara à café/té, grande  
 cucchiaio caffè/té grande



■ 01.0411.6060  
 ■ 11.0411.6040  
**Gourmetlöffel**  
 190 mm/7 1/2 in.  
 gourmet spoon  
 cuiller à sauce  
 cuchara gourmet  
 cucchiaio gourmet



■ 01.0435.6062  
 ■ 11.0435.6042  
**Fischgabel**  
 183 mm/7 1/4 in.  
 fish fork  
 fourchette à poisson  
 tenedor pescado  
 forchetta pesce



■ 01.0435.6063  
 ■ 11.0435.6043  
**Fischmesser**  
 206 mm/8 in.  
 fish knife  
 couteau à poisson  
 cuchillo pescado  
 coltello pesce



■ 01.0440.6060  
 ■ 11.0440.6040  
**Austerngabel**  
 145 mm/5 3/4 in.  
 oyster fork  
 fourchette à huîtres  
 tenedor ostras  
 forchetta per ostriche



■ 01.0464.6060  
 ■ 11.0464.6040  
**Kuchengabel**  
 157 mm/6 1/4 in.  
 cake fork  
 fourchette à gâteau  
 tenedor lunch  
 forchetta per dolce



■ 01.0466.6069  
 ■ 11.0466.6049  
**Brot- /  
 Buttermesser\*\***  
 170 mm/6 3/4 in.  
 bread/butter knife\*\*  
 couteau de table\*\*  
 cuchillo lunch\*\*  
 coltello per dolce\*\*



■ 01.0472.6060  
 ■ 11.0472.6040  
**Limolöffel**  
 220 mm/8 3/4 in.  
 iced tea spoon  
 cuiller à soda  
 cuchara refresco  
 cucchiaio bibita



■ 01.0478.6069  
 ■ 11.0478.6049  
**Steakmesser\*\***  
 230 mm/9 in.  
 steak knife\*\*  
 couteau à steak\*\*  
 cuchillo steak\*\*  
 coltello da bistecca\*\*



■ 01.0489.6060  
 ■ 11.0489.6040  
**Tassenlöffel**  
 166 mm/6 1/2 in.  
 round bowl soup spoon  
 cuiller à bouillon  
 cuchara sopa  
 cucchiaio da brodo



VPE 12 Stk. / Unit 12 pcs.

- perfekte Versilberung / perfectly silverplated
- Cromargan®, poliert / stainless 18/10, polished

\* Hohlheft mit Wellenschliff / hollow-handled with serrated edge

\*\* Klingenstahl mit Wellenschliff / monobloc with serrated edge





■ **01 0400 6060**  
 perfekt versilbert  
 perfectly silverplated  
 chromage parfait  
 plateado perfecto  
 perfetta placcatura in argento

■ **11 0400 6040**  
 Cromargan®, poliert  
 Cromargan®, polished  
 Cromargan®, poli  
 Cromargan®, pulido  
 Cromargan®, lucido

Bistro betont mit schlichtem Design und klaren Linien die unterschiedlichsten Arrangements auf ideale Weise – mit prägnanten, kreisrunden Löffelkellen als optischer Blickfang.

With its simple design and clear lines, Bistro is the ideal complement to all kinds of table arrangements. The spoons, with their striking, circular bowls are particularly eye-catching.

**BISTRO**  
 0400



Le   
Menu

*Essentielle Pastasorte* der Schafskäsehaube  
dazu Baguette

  
*Champcocktail*  
mit frischem Dill

  
*Cordon Bleu*  
mit Rahmsauce, Kroketten und Salat der Saison

  
*Crème Brûlée*  
vom Grand Cru Yellow Bourbon Café





Kunstvoll.  
Elaborate.

Dynamisch.  
Dynamic.

Markant.  
Striking.

FLAIR

■ 10.1101.6060  
■ 12.1101.6040

**Menuelöffel**  
207 mm/8<sup>1</sup>/<sub>4</sub> in.  
table spoon  
cuiller de table  
cuchara mesa  
cucchiaio tavola



■ 10.1102.6060  
■ 12.1102.6040

**Menuegabel**  
205 mm/8 in.  
table fork  
fourchette de table  
tenedor mesa  
forchetta tavola



■ 10.1103.6067  
■ 12.1103.6047

**Menuemesser\***  
237 mm/9<sup>1</sup>/<sub>2</sub> in.  
table knife\*  
couteau de table\*  
cuchillo mesa\*  
coltello tavola cutinato\*



■ 10.1103.6069  
■ 12.1103.6049

**Menuemesser\*\***  
230 mm/9 in.  
table knife\*\*  
couteau de table\*\*  
cuchillo mesa\*\*  
coltello tavola cutinato\*\*



■ 10.1104.6060  
■ 12.1104.6040

**Vorspeisenlöffel**  
183 mm/7<sup>1</sup>/<sub>4</sub> in.  
dessert spoon  
cuiller à dessert  
cuchara postre  
cucchiaio frutta



■ 10.1105.6060  
■ 12.1105.6040

**Vorspeisengabel**  
181 mm/7 in.  
dessert fork  
fourchette à dessert  
tenedor postre  
forchetta frutta



■ 10.1106.6067  
■ 12.1106.6047

**Vorspeisen-  
messer\***  
214 mm/8<sup>1</sup>/<sub>2</sub> in.  
dessert knife\*  
couteau à dessert\*  
cuchillo postre\*  
coltello frutta\*



■ 10.1106.6069  
■ 12.1106.6049

**Vorspeisen-  
messer\*\***  
207 mm/8<sup>1</sup>/<sub>4</sub> in.  
dessert knife\*\*  
couteau à dessert\*\*  
cuchillo postre\*\*  
coltello frutta\*\*



■ 10.1107.6060  
■ 12.1107.6040

**Kaffeelöffel**  
132 mm/5<sup>1</sup>/<sub>4</sub> in.  
tea/coffee spoon  
cuiller à café  
cuchara café  
cucchiaio caffè/té



■ 10.1109.6060  
■ 12.1109.6040

**Espresso- /  
Mokkalöffel**  
108 mm/4<sup>1</sup>/<sub>4</sub> in.  
demi-tasse spoon  
cuiller à mocca  
cuchara moca  
cucchiaio moca



■ 10.1110.6060  
■ 12.1110.6040

**Vorspeisen- /  
Dessertlöffel**  
156 mm/6 in.  
coffee/tea spoon, large  
cuiller à café/té, grande  
cuchara à café/té, grande  
cucchiaio caffè/té, grande



■ 10.1111.6060  
■ 12.1111.6040

**Gourmetlöffel**  
190 mm/7<sup>1</sup>/<sub>2</sub> in.  
gourmet spoon  
cuiller à sauce  
cuchara gourmet  
cucchiaio gourmet



■ 10.1135.6062  
■ 12.1135.6042

**Fischgabel**  
183 mm/7<sup>1</sup>/<sub>4</sub> in.  
fish fork  
fourchette à poisson  
tenedor pescado  
forchetta pesce



■ 10.1135.6063  
■ 12.1135.6043

**Fischmesser**  
206 mm/8 in.  
fish knife  
couteau à poisson  
cuchillo pescado  
coltello pesce



■ 10.1140.6060  
■ 12.1140.6040

**Austerngabel**  
149 mm/5<sup>3</sup>/<sub>4</sub> in.  
oyster fork  
fourchette à huîtres  
tenedor ostras  
forchetta per ostriche



■ 10.1164.6060  
■ 12.1164.6040

**Kuchengabel**  
157 mm/6<sup>1</sup>/<sub>4</sub> in.  
cake fork  
fourchette à gâteau  
tenedor lunch  
forchetta per dolce



■ 10.1166.6069  
■ 12.1166.6049

**Brot- /  
Buttermesser\*\***  
170 mm/6<sup>3</sup>/<sub>4</sub> in.  
bread/butter knife\*\*  
couteau de table\*\*  
cuchillo lunch\*\*  
coltello per dolce\*\*



■ 10.1172.6060  
■ 12.1172.6040

**Limolöffel**  
220 mm/8<sup>3</sup>/<sub>4</sub> in.  
iced tea spoon  
cuiller à soda  
cuchara refresco  
cucchiaio bibita



■ 10.1178.6069  
■ 12.1178.6049

**Steakmesser\*\***  
226 mm/9 in.  
steak knife\*\*  
couteau à steak\*\*  
cuchillo steak\*\*  
coltello da bistecca\*\*



■ 10.1189.6060  
■ 12.1189.6040

**Tassenlöffel**  
166 mm/6<sup>1</sup>/<sub>2</sub> in.  
round bowl soup spoon  
cuiller à bouillon  
cuchara sopa  
cucchiaio da brodo



VPE 12 Stk. / Unit 12 pcs.

- perfekte Versilberung / perfectly silverplated
- Cromargan®, poliert / stainless 18/10, polished

\* Hohlheft mit Wellenschliff / hollow-handled with serrated edge

\*\* Klingenstahl mit Wellenschliff / monobloc with serrated edge





■ **10 1100 6060**  
 perfekt versilbert  
 perfectly silverplated  
 chromage parfait  
 plateado perfecto  
 perfetta placcatura in argento

■ **12 1100 6040**  
 Cromargan®, poliert  
 Cromargan®, polished  
 Cromargan®, poli  
 Cromargan®, pulido  
 Cromargan®, lucido

Flair ist mit seinen spitz zulaufenden Griffen und filigranem Dekor ein aufmerksamkeitsstarkes Element auf dem gedeckten Tisch. Das filigrane Dekor geht eine perfekte Symbiose mit funktionalem Design ein.

With its tapered handles and elegant decorative elements, Flair is a striking addition to any well-laid table. This collection is a perfect combination of elegance and functional design.

**FLAIR**  
 1100







Agil.  
Agile.

Zurückhaltend.  
Restrained.

Grazil.  
Graceful.

CLUB

■ 11.4701.6040

**Menuelöffel**

199 mm/8 in.  
table spoon  
cuiller de table  
cuchara mesa  
cucchiaio tavola



■ 11.4710.6040

**Vorspeisen- /  
Dessertlöffel**

156 mm/6 1/4 in.  
coffee/tea spoon, large  
cuiller à café/té, grande  
cuchara lunch  
cucchiaio caffè/té, grande



■ 11.4702.6040

**Menuegabel**

197 mm/7 3/4 in.  
table fork  
fourchette de table  
tenedor mesa  
forchetta tavola



■ 11.4711.6040

**Gourmetlöffel**

186 mm/7 1/4 in.  
gourmet spoon  
cuiller à sauce  
cuchara gourmet  
cucchiaio gourmet



■ 11.4703.6047

**Menuemesser\***

217 mm/8 1/2 in.  
table knife\*  
couteau de table\*  
cuchillo mesa\*  
coltello tavola cutinato\*



■ 11.4735.6042

**Fischgabel**

183 mm/7 1/4 in.  
fish fork  
fourchette à poisson  
tenedor pescado  
forchetta pesce



■ 11.4703.6049

**Menuemesser\*\***

215 mm/8 1/2 in.  
table knife\*\*  
couteau de table\*\*  
cuchillo mesa\*\*  
coltello tavola cutinato\*\*



■ 11.4735.6043

**Fischmesser**

206 mm/8 in.  
fish knife  
couteau à poisson  
cuchillo pescado  
coltello pesce



■ 11.4704.6040

**Vorspeisenlöffel**

183 mm/7 1/4 in.  
dessert spoon  
cuiller à dessert  
cuchara postre  
cucchiaio frutta



■ 11.4740.6040

**Austerngabel**

146 mm/5 3/4 in.  
oyster fork  
fourchette à huîtres  
tenedor ostras  
forchetta per ostriche



■ 11.4705.6040

**Vorspeisengabel**

181 mm/7 1/4 in.  
dessert fork  
fourchette à dessert  
tenedor postre  
forchetta frutta



■ 11.4764.6040

**Kuchengabel**

157 mm/6 1/4 in.  
cake fork  
fourchette à gâteau  
tenedor lunch  
forchetta per dolce



■ 11.4706.6047

**Vorspeisen-  
messer\***

201 mm/8 in.  
dessert knife\*  
couteau à dessert\*  
cuchillo postre\*  
coltello frutta\*



■ 11.4766.6049

**Brot- /  
Buttermesser\*\***

170 mm/6 3/4 in.  
bread/butter knife\*\*  
couteau de table\*\*  
cuchillo lunch\*\*  
coltello per dolce\*\*



■ 11.4706.6049

**Vorspeisen-  
messer\*\***

197 mm/7 3/4 in.  
dessert knife\*\*  
couteau à dessert\*\*  
cuchillo postre\*\*  
coltello frutta\*\*



■ 11.4772.6040

**Limolöffel**

220 mm/8 3/4 in.  
iced tea spoon  
cuiller à soda  
cuchara refresco  
cucchiaio bibita



■ 11.4707.6040

**Kaffeelöffel**

132 mm/5 1/4 in.  
tea/coffee spoon  
cuiller à café  
cuchara café  
cucchiaio caffè/té



■ 11.4778.6049

**Steakmesser\*\***

219 mm/8 3/4 in.  
steak knife\*\*  
couteau à steak\*\*  
cuchillo steak\*\*  
coltello da bistecca\*\*



■ 11.4709.6040

**Espresso- /  
Mokkalöffel**

108 mm/4 1/4 in.  
demi-tasse spoon  
cuiller à moca  
cuchara moca  
cucchiaio moca



■ 11.4789.6040

**Tassenlöffel**

166 mm/6 1/2 in.  
round bowl soup spoon  
cuiller à bouillon  
cuchara sopa  
cucchiaio da brodo



VPE 12 Stk. / Unit 12 pcs.

■ Cromargan®, poliert /  
stainless 18/10, polished

\* Hohlheft mit Wellenschliff /  
hollow-handled with serrated edge

\*\* Klingenstahl mit Wellenschliff /  
monobloc with serrated edge





■ 11 4700 6040  
 Cromargan®, poliert  
 Cromargan®, polished  
 Cromargan®, poli  
 Cromargan®, pulido  
 Cromargan®, lucido

Club ist mit seiner flexiblen und gleichzeitig markanten Ästhetik ein Allround-Talent. Mit einer umlaufenden Schmucklinie eignet sich die Kollektion für einfach wie festlich gedeckte Tische.

With its flexible, yet striking aesthetics, Club is a real all-rounder. The decorative line around the edge makes this collection ideal for both simple and festively laid tables.

**CLUB**  
 4700



Exklusive Unikate in stone-washed Ausführung.  
Exclusive unique pieces in stone-washed finishing.





Ausdrucksstark.  
Expressive.

Flexibel.  
Flexible.

Überraschend.  
Surprising.

**BAGUETTE**

■ 01.0101.6060  
 ■ 11.0101.6040  
 ■ 59.0101.8190

**Menuelöffel**  
 211 mm/8<sup>1</sup>/<sub>4</sub> in.  
 table spoon  
 cuiller de table  
 cuchara mesa  
 cucchiaio tavola



■ 01.0102.6060  
 ■ 11.0102.6040  
 ■ 59.0102.8190

**Menuegabel**  
 211 mm/8<sup>1</sup>/<sub>4</sub> in.  
 table fork  
 fourchette de table  
 tenedor mesa  
 forchetta tavola



■ 01.0115.6061  
 ■ 11.0115.6041

**Menuelöffel, klein**  
 196 mm/7<sup>3</sup>/<sub>4</sub> in.  
 tasting spoon, small  
 cuiller de table, petit  
 cuchara menu, pequeño  
 cucchiaio menu, piccolo



■ 01.0115.6062  
 ■ 11.0115.6042

**Menuegabel, klein**  
 196 mm/7<sup>3</sup>/<sub>4</sub> in.  
 tasting fork, small  
 fourchette de table, petite  
 tenedor menu, pequeño  
 forchetta menu, piccolo



■ 01.0103.6067  
 ■ 11.0103.6047

**Menuemesser\***  
 231 mm/9 in.  
 table knife\*  
 couteau de table\*  
 cuchillo mesa\*  
 coltello tavola cutinato\*



■ 01.0103.6069  
 ■ 11.0103.6049  
 ■ 59.0103.8190

**Menuemesser\*\***  
 231 mm/9 in.  
 table knife\*\*  
 couteau de table\*\*  
 cuchillo mesa\*\*  
 coltello tavola cutinato\*\*



■ 01.0104.6060  
 ■ 11.0104.6040  
 ■ 59.0104.8190

**Vorspeisenlöffel**  
 183 mm/7<sup>1</sup>/<sub>4</sub> in.  
 dessert spoon  
 cuiller à dessert  
 cuchara postre  
 cucchiaio frutta



■ 01.0105.6060  
 ■ 11.0105.6040  
 ■ 59.0105.8190

**Vorspeisengabel**  
 179 mm/7 in.  
 dessert fork  
 fourchette à dessert  
 tenedor postre  
 forchetta frutta



■ 01.0106.6067  
 ■ 11.0106.6047

**Vorspeisenmesser\***  
 214 mm/8<sup>1</sup>/<sub>2</sub> in.  
 dessert knife\*  
 couteau à dessert\*  
 cuchillo postre\*  
 coltello frutta\*



■ 01.0106.6069  
 ■ 11.0106.6049  
 ■ 59.0106.8190

**Vorspeisenmesser\*\***  
 214 mm/8<sup>1</sup>/<sub>2</sub> in.  
 dessert knife\*\*  
 couteau à dessert\*\*  
 cuchillo postre\*\*  
 coltello frutta\*\*



■ 01.0107.6060  
 ■ 11.0107.6040  
 ■ 59.0107.8190

**Kaffeelöffel**  
 147 mm/5<sup>3</sup>/<sub>4</sub> in.  
 tea/coffee spoon  
 cuiller à café  
 cuchara café  
 cucchiaio caffè/té



■ 01.0109.6060  
 ■ 11.0109.6040  
 ■ 59.0109.8190

**Espresso- / Mokkalöffel**  
 114 mm/4<sup>1</sup>/<sub>2</sub> in.  
 demi-tasse spoon  
 cuiller à moca  
 cuchara moca  
 cucchiaio moca



■ 01.0110.6060  
 ■ 11.0110.6040  
 ■ 59.0110.8190

**Vorspeisen- / Dessertlöffel**  
 165 mm/6<sup>1</sup>/<sub>2</sub> in.  
 coffee/tea spoon, large  
 cuiller à café/té, grande  
 cuchara à café/té, grande  
 cucchiaio caffè/té, grande



■ 01.0111.6060  
 ■ 11.0111.6040

**Gourmetlöffel**  
 186 mm/7<sup>1</sup>/<sub>4</sub> in.  
 gourmet spoon  
 cuiller à sauce  
 cuchara gourmet  
 cucchiaio gourmet



■ 01.0135.6062  
 ■ 11.0135.6042

**Fischgabel**  
 179 mm/7 in.  
 fish fork  
 fourchette à poisson  
 tenedor pescado  
 forchetta pesce



■ 01.0135.6063  
 ■ 11.0135.6043

**Fischmesser**  
 215 mm/8<sup>1</sup>/<sub>2</sub> in.  
 fish knife  
 couteau à poisson  
 cuchillo pescado  
 coltello pesce



■ 01.0140.6060  
 ■ 11.0140.6040

**Austerngabel**  
 141 mm/5<sup>1</sup>/<sub>2</sub> in.  
 oyster fork  
 fourchette à huîtres  
 tenedor ostras  
 forchetta per ostriche



■ 01.0164.6060  
 ■ 11.0164.6040  
 ■ 59.0164.8190

**Kuchengabel**  
 163 mm/6<sup>1</sup>/<sub>2</sub> in.  
 cake fork  
 fourchette à gâteau  
 tenedor lunch  
 forchetta per dolce



■ 01.0166.6069  
 ■ 11.0166.6049  
 ■ 59.0166.8190

**Brot- / Buttermesser\*\***  
 170 mm/6<sup>3</sup>/<sub>4</sub> in.  
 bread/butter knife\*\*  
 couteau de table\*\*  
 cuchillo lunch\*\*  
 coltello per dolce\*\*



■ 01.0172.6060  
 ■ 11.0172.6040

**Limolöffel**  
 220 mm/8<sup>3</sup>/<sub>4</sub> in.  
 iced tea spoon  
 cuiller à soda  
 cuchara refresco  
 cucchiaio bibita



■ 01.0178.6067  
 ■ 11.0178.6047

**Steakmesser\***  
 220 mm/8<sup>3</sup>/<sub>4</sub> in.  
 steak knife\*  
 couteau à steak\*  
 cuchillo steak\*  
 coltello da bistecca\*



■ 11.0178.6049  
 ■ 59.0178.8190

**Steakmesser\*\***  
 234 mm/9<sup>1</sup>/<sub>4</sub> in.  
 steak knife\*\*  
 couteau à steak\*\*  
 cuchillo steak\*\*  
 coltello da bistecca\*\*



■ 01.0189.6060  
 ■ 11.0189.6040

**Tassenlöffel**  
 168 mm/6<sup>3</sup>/<sub>4</sub> in.  
 round bowl soup spoon  
 cuiller à bouillon  
 cuchara sopa  
 cucchiaio da brodo



VPE 12 Stk. / Unit 12 pcs.

- perfekte Versilberung / perfectly silverplated
- Cromargan®, poliert / stainless 18/10, polished
- Stone-washed

\* Hohlheft mit Wellenschliff / hollow-handled with serrated edge

\*\* Klingenstahl mit Wellenschliff / monobloc with serrated edge





**NEU NEW**  
**STONE-WASHED**  
 lagerhaltig on stock

■ **59 0100 8190**  
 Cromargan®, stone-washed  
 stainless 18/10, stone-washed

■ **01 0100 6060**  
 perfekt versilbert  
 perfectly silverplated  
 chromage parfait  
 plateado perfecto  
 perfetta placcatura in argento

■ **11 0100 6040**  
 Cromargan®, poliert  
 Cromargan®, polished  
 Cromargan®, poli  
 Cromargan®, pulido  
 Cromargan®, lucido

Baguette verfügt dank seiner beeindruckenden Größe über besondere Prägnanz. Die markanten Kerben und erhabenen Oberflächen setzen plastische Akzente.

Thanks to its impressive size, Baguette makes a particularly striking impact. Characteristic notches and raised surfaces give this collection a sculpted look.

**BAGUETTE**  
 0100



























Geometrisch.  
Geometric.

Hochwertig.  
Classy.

Unabhängig.  
Independent.

MONDIAL

- |  |   |  |   |  |  |
|--|---|--|---|--|--|
| <p>■ 10.6201.6060<br/>■ 12.6201.6040</p>                                | <p><b>Menuelöffel</b><br/>203 mm/8 in.<br/>table spoon<br/>cuiller de table<br/>cuchara mesa<br/>cucchiaio tavola</p>   | <p>■ 10.6207.6060<br/>■ 12.6207.6040</p>    | <p><b>Kaffeelöffel</b><br/>132 mm/5 1/4 in.<br/>tea/coffee spoon<br/>cuiller à café<br/>cuchara café<br/>cucchiaio caffè/té</p>   | <p>■ 10.6278.6069<br/>■ 12.6278.6049</p>  | <p><b>Steakmesser**</b><br/>229 mm/9 in.<br/>steak knife**<br/>couteau à steak**<br/>cuchillo steak**<br/>coltello da bistecca**</p>     |
| <p>■ 10.6202.6060<br/>■ 12.6202.6040</p>                                | <p><b>Menuegabel</b><br/>201 mm/8 in.<br/>table fork<br/>fourchette de table<br/>tenedor mesa<br/>forchetta tavola</p>  | <p>■ 10.6209.6060<br/>■ 12.6209.6040</p>    | <p><b>Espresso- / Mokkalöffel</b><br/>108 mm/4 1/4 in.<br/>demi-tasse spoon<br/>cuiller à moca<br/>cuchara moca<br/>cucchiaio moca</p>  | <p>■ 10.6289.6060<br/>■ 12.6289.6040</p>  | <p><b>Tassenlöffel</b><br/>166 mm/6 1/2 in.<br/>round bowl soup spoon<br/>cuiller à bouillon<br/>cuchara sopa<br/>cucchiaio da brodo</p> |
| <p>■ 12.6202.6042</p>   | <p><b>Menuegabel, lang</b><br/>210 mm/8 1/2 in.<br/>table fork, long<br/>fourchette de table, longue<br/>tenedor mesa, largo<br/>forchetta tavola, lungo</p>        | <p>■ 10.6210.6060<br/>■ 12.6210.6040</p>    | <p><b>Vorspeisen- / Dessertlöffel</b><br/>156 mm/6 1/4 in.<br/>coffee/tea spoon, large<br/>cuiller à café/té, grande<br/>cuchara à café/té, grande<br/>cucchiaio caffè/té, grande</p> |  |  |
| <p>■ 10.6203.6067<br/>■ 12.6203.6047</p>              | <p><b>Gourmetlöffel</b><br/>186 mm/7 1/4 in.<br/>gourmet spoon<br/>cuiller à sauce<br/>cuchara gourmet<br/>cucchiaio gourmet</p>                                    |  |   |  |  |
| <p>■ 10.6203.6069<br/>■ 12.6203.6049</p>                               | <p><b>Menuemesser**</b><br/>229 mm/9 in.<br/>table knife**<br/>couteau de table**<br/>cuchillo mesa**<br/>coltello tavola cutinato**</p>                            | <p>■ 10.6235.6062<br/>■ 12.6235.6042</p>   | <p><b>Fischgabel</b><br/>183 mm/7 1/4 in.<br/>fish fork<br/>fourchette à poisson<br/>tenedor pescado<br/>forchetta pesce</p>  |  |  |
| <p>■ 12.6233.6049</p>   | <p><b>Menuemesser**, lang</b><br/>240 mm/9 1/2 in.<br/>table knife**, long<br/>couteau de table**, long<br/>cuchillo mesa**, largo<br/>coltello tavola**, lungo</p> | <p>■ 10.6235.6063<br/>■ 12.6235.6043</p>  | <p><b>Fischmesser</b><br/>206 mm/8 in.<br/>fish knife<br/>couteau à poisson<br/>cuchillo pescado<br/>coltello pesce</p>   |  |  |
| <p>■ 10.6204.6060<br/>■ 12.6204.6040</p>                              | <p><b>Vorspeisenlöffel</b><br/>187 mm/7 1/2 in.<br/>dessert spoon<br/>cuiller à dessert<br/>cuchara postre<br/>cucchiaio frutta</p>                                 | <p>■ 10.6240.6060<br/>■ 12.6240.6040</p>  | <p><b>Austerngabel</b><br/>138 mm/5 1/2 in.<br/>oyster fork<br/>fourchette à huîtres<br/>tenedor ostras<br/>forchetta per ostriche</p>  |  |  |
| <p>■ 10.6205.6060<br/>■ 12.6205.6040</p>                              | <p><b>Vorspeisengabel</b><br/>185 mm/7 1/4 in.<br/>dessert fork<br/>fourchette à dessert<br/>tenedor postre<br/>forchetta frutta</p>                                | <p>■ 10.6264.6060<br/>■ 12.6264.6040</p>  | <p><b>Kuchengabel</b><br/>157 mm/6 1/4 in.<br/>cake fork<br/>fourchette à gâteau<br/>tenedor lunch<br/>forchetta per dolce</p>  |  |  |
| <p>■ 10.6206.6067<br/>■ 12.6206.6047</p>  | <p><b>Brot- / Buttermesser**</b><br/>170 mm/6 3/4 in.<br/>bread/butter knife**<br/>couteau de table**<br/>cuchillo lunch**<br/>coltello per dolce**</p>             |  |   |  |  |
| <p>■ 10.6206.6069<br/>■ 12.6206.6049</p>                              | <p><b>Vorspeisenmesser**</b><br/>213 mm/8 1/2 in.<br/>dessert knife**<br/>couteau à dessert**<br/>cuchillo postre**<br/>coltello frutta**</p>                       | <p>■ 10.6272.6060<br/>■ 12.6272.6040</p>  | <p><b>Limolöffel</b><br/>220 mm/8 3/4 in.<br/>iced tea spoon<br/>cuiller à soda<br/>cuchara refresco<br/>cucchiaio bibita</p>   |  |  |

VPE 12 Stk. / Unit 12 pcs.

■ perfekte Versilberung / perfectly silverplated

■ Cromargan®, poliert / stainless 18/10, polished

\* Hohlheft mit Wellenschliff / hollow-handled with serrated edge

\*\* Klingenstahl mit Wellenschliff / monobloc with serrated edge





■ **10 6200 6060**  
 perfekt versilbert  
 perfectly silverplated  
 chromage parfait  
 plateado perfecto  
 perfetta placcatura in argento

■ **12 6200 6040**  
 Cromargan®, poliert  
 Cromargan®, polished  
 Cromargan®, poli  
 Cromargan®, pulido  
 Cromargan®, lucido

Mondial akzentuiert mit seinem trapezförmigen Design klassische Arrangements auf einprägsame Weise. Dank der hochwertigen Verarbeitung passt die Serie besonders zu erlesenen Konzepten.

With its trapezoidal design, Mondial makes a memorable addition to classic table arrangements. Thanks to the high-quality workmanship, this collection is a particularly good fit with refined concepts.

**MONDIAL**  
 6200





























Stattlich.  
Majestic.

Klar.  
Clear.

Variabel.  
Versatile.

RESIDENCE

- |  |   |  |   |  |  |
|--|---|--|---|--|--|
| <p>■ 10.4801.6060<br/>■ 12.4801.6040</p>    | <p><b>Menuelöffel</b><br/>204 mm/8 in.<br/>table spoon<br/>cuiller de table<br/>cuchara mesa<br/>cucchiaio tavola</p>   | <p>■ 10.4807.6060<br/>■ 12.4807.6040</p>    | <p><b>Kaffeelöffel</b><br/>132 mm/5 1/4 in.<br/>tea/coffee spoon<br/>cuiller à café<br/>cuchara café<br/>cucchiaio caffè/té</p>   | <p>■ 12.4878.6047</p>                     | <p><b>Steakmesser*</b><br/>220 mm/8 1/2 in.<br/>steak knife*<br/>couteau à steak*<br/>cuchillo steak*<br/>coltello da bistecca*</p>      |
| <p>■ 10.4802.6060<br/>■ 12.4802.6040</p>    | <p><b>Menuegabel</b><br/>202 mm/8 in.<br/>table fork<br/>fourchette de table<br/>tenedor mesa<br/>forchetta tavola</p>  | <p>■ 10.4809.6060<br/>■ 12.4809.6040</p>    | <p><b>Espresso- / Mokkalöffel</b><br/>108 mm/4 1/4 in.<br/>demi-tasse spoon<br/>cuiller à moca<br/>cuchara moca<br/>cucchiaio moca</p>  | <p>■ 12.4878.6049</p>                     | <p><b>Steakmesser**</b><br/>228 mm/9 in.<br/>steak knife**<br/>couteau à steak**<br/>cuchillo steak**<br/>coltello da bistecca**</p>     |
| <p>■ 12.4802.6042</p>                       | <p><b>Menuegabel, lang</b><br/>210 mm/8 1/2 in.<br/>table fork, long<br/>fourchette de table, longue<br/>tenedor mesa, largo<br/>forchetta tavola, lungo</p>        | <p>■ 10.4810.6060<br/>■ 12.4810.6040</p>    | <p><b>Vorspeisen- / Dessertlöffel</b><br/>157 mm/6 1/4 in.<br/>coffee/tea spoon, large<br/>cuiller à café/té, grande<br/>cuchara à café/té, grande<br/>cucchiaio caffè/té, grande</p> | <p>■ 10.4889.6060<br/>■ 12.4889.6040</p>  | <p><b>Tassenlöffel</b><br/>166 mm/6 1/2 in.<br/>round bowl soup spoon<br/>cuiller à bouillon<br/>cuchara sopa<br/>cucchiaio da brodo</p> |
| <p>■ 10.4803.6067<br/>■ 12.4803.6047</p>    | <p><b>Menuemesser*</b><br/>226 mm/9 in.<br/>table knife*<br/>couteau de table*<br/>cuchillo mesa*<br/>coltello tavola cutinato*</p>                                 | <p>■ 10.4811.6060<br/>■ 12.4811.6040</p>    | <p><b>Gourmetlöffel</b><br/>186 mm/7 1/4 in.<br/>gourmet spoon<br/>cuiller à sauce<br/>cuchara gourmet<br/>cucchiaio gourmet</p>  |  |  |
| <p>■ 10.4803.6069<br/>■ 12.4803.6049</p>   | <p><b>Menuemesser**</b><br/>227 mm/9 in.<br/>table knife**<br/>couteau de table**<br/>cuchillo mesa**<br/>coltello tavola cutinato**</p>                            | <p>■ 10.4835.6062<br/>■ 12.4835.6042</p>   | <p><b>Fischgabel</b><br/>176 mm/7 in.<br/>fish fork<br/>fourchette à poisson<br/>tenedor pescado<br/>forchetta pesce</p>  |  |  |
| <p>■ 12.4833.6049</p>                     | <p><b>Menuemesser**, lang</b><br/>240 mm/9 1/2 in.<br/>table knife**, long<br/>couteau de table**, long<br/>cuchillo mesa**, largo<br/>coltello tavola**, lungo</p> | <p>■ 10.4835.6063<br/>■ 12.4835.6043</p>  | <p><b>Fischmesser</b><br/>198 mm/7 3/4 in.<br/>fish knife<br/>couteau à poisson<br/>cuchillo pescado<br/>coltello pesce</p>   |  |  |
| <p>■ 10.4804.6060<br/>■ 12.4804.6040</p>  | <p><b>Vorspeisenlöffel</b><br/>187 mm/7 1/2 in.<br/>dessert spoon<br/>cuiller à dessert<br/>cuchara postre<br/>cucchiaio frutta</p>                                 | <p>■ 10.4840.6060<br/>■ 12.4840.6040</p>  | <p><b>Austerngabel</b><br/>140 mm/5 1/2 in.<br/>oyster fork<br/>fourchette à huîtres<br/>tenedor ostras<br/>forchetta per ostriche</p>  |  |  |
| <p>■ 10.4805.6060<br/>■ 12.4805.6040</p>  | <p><b>Vorspeisengabel</b><br/>186 mm/7 1/4 in.<br/>dessert fork<br/>fourchette à dessert<br/>tenedor postre<br/>forchetta frutta</p>                                | <p>■ 10.4864.6060<br/>■ 12.4864.6040</p>  | <p><b>Kuchengabel</b><br/>157 mm/6 1/4 in.<br/>cake fork<br/>fourchette à gâteau<br/>tenedor lunch<br/>forchetta per dolce</p>  |  |  |
| <p>■ 10.4806.6067<br/>■ 12.4806.6047</p>  | <p><b>Vorspeisenmesser*</b><br/>212 mm/8 1/4 in.<br/>dessert knife*<br/>couteau à dessert*<br/>cuchillo postre*<br/>coltello frutta*</p>                            | <p>■ 10.4866.6069<br/>■ 12.4866.6049</p>  | <p><b>Brot- / Buttermesser**</b><br/>170 mm/6 3/4 in.<br/>bread/butter knife**<br/>couteau de table**<br/>cuchillo lunch**<br/>coltello per dolce**</p>                               |  |  |
| <p>■ 10.4806.6069<br/>■ 12.4806.6049</p>  | <p><b>Vorspeisenmesser**</b><br/>212 mm/8 1/4 in.<br/>dessert knife**<br/>couteau à dessert**<br/>cuchillo postre**<br/>coltello frutta**</p>                       | <p>■ 10.4872.6060<br/>■ 12.4872.6040</p>  | <p><b>Limolöffel</b><br/>220 mm/8 3/4 in.<br/>iced tea spoon<br/>cuiller à soda<br/>cuchara refresco<br/>cucchiaio bibita</p>   |  |  |

VPE 12 Stk. / Unit 12 pcs.

- perfekte Versilberung / perfectly silverplated
- Cromargan®, poliert / stainless 18/10, polished
- \* Hohlheft mit Wellenschliff / hollow-handled with serrated edge
- \*\* Klingenstahl mit Wellenschliff / monobloc with serrated edge





■ **10 4800 6060**  
 perfekt versilbert  
 perfectly silverplated  
 chromage parfait  
 plateado perfecto  
 perfetta placcatura in argento

■ **12 4800 6040**  
 Cromargan®, poliert  
 Cromargan®, polished  
 Cromargan®, poli  
 Cromargan®, pulido  
 Cromargan®, lucido

Residence interpretiert den Barockstil auf neue Weise. In auserlesenen Tisch-Arrangements mit modernem Touch kommt die Schönheit der klaren Linienführung besonders zur Geltung.

Residence takes the baroque style in a new direction. Sophisticated table arrangements with a modern touch really emphasize the beauty of its clear lines.

**RESIDENCE**  
 4800







Formvollendet.  
Accomplished.

Stilsicher.  
Stylish.

Einprägsam.  
Memorable.

**METROPOLITAN**

■ 10.5401.6060

**Menuelöffel**

■ 12.5401.6040

199 mm/8 in.  
table spoon  
cuiller de table  
cuchara mesa  
cucchiaio tavola



■ 10.5402.6060

**Menuegabel**

■ 12.5402.6040

197 mm/7 1/2 in.  
table fork  
fourchette de table  
tenedor mesa  
forchetta tavola



■ 10.5403.6067

**Menuemesser\***

■ 12.5403.6047

216 mm/8 1/2 in.  
table knife\*  
couteau de table\*  
cuchillo mesa\*  
coltello tavola cutinato\*



■ 10.5403.6069

**Menuemesser\*\***

■ 12.5403.6049

215 mm/8 1/2 in.  
table knife\*\*  
couteau de table\*\*  
cuchillo mesa\*\*  
coltello tavola cutinato\*\*



■ 10.5404.6060

**Vorspeisenlöffel**

■ 12.5404.6040

187 mm/7 1/2 in.  
dessert spoon  
cuiller à dessert  
cuchara postre  
cucchiaio frutta



■ 10.5405.6060

**Vorspeisengabel**

■ 12.5405.6040

185 mm/7 1/4 in.  
dessert fork  
fourchette à dessert  
tenedor postre  
forchetta frutta



■ 10.5406.6067

**Vorspeisen-**

■ 12.5406.6047

205 mm/8 in.  
dessert knife\*  
couteau à dessert\*  
cuchillo postre\*  
coltello frutta\*



■ 10.5406.6069

**Vorspeisen-**

■ 12.5406.6049

205 mm/8 in.  
dessert knife\*\*  
couteau à dessert\*\*  
cuchillo postre\*\*  
coltello frutta\*\*



■ 10.5407.6060

**Kaffeelöffel**

■ 12.5407.6040

132 mm/5 1/4 in.  
tea/coffee spoon  
cuiller à café  
cuchara café  
cucchiaio caffè/té



■ 10.5409.6060

**Espresso- /**

■ 12.5409.6040

108 mm/4 1/4 in.  
demi-tasse spoon  
cuiller à moca  
cuchara moca  
cucchiaio moca



■ 10.5410.6060

**Vorspeisen- /**

■ 12.5410.6040

156 mm/6 1/4 in.  
coffee/tea spoon, large  
cuiller à café/té, grande  
cuchara à café/té, grande  
cucchiaio caffè/té, grande



■ 10.5411.6060

**Gourmetlöffel**

■ 12.5411.6040

191 mm/7 1/2 in.  
gourmet spoon  
cuiller à sauce  
cuchara gourmet  
cucchiaio gourmet



■ 10.5435.6062

**Fischgabel**

■ 12.5435.6042

177 mm/7 in.  
fish fork  
fourchette à poisson  
tenedor pescado  
forchetta pesce



■ 10.5435.6063

**Fischmesser**

■ 12.5435.6043

199 mm/8 in.  
fish knife  
couteau à poisson  
cuchillo pescado  
coltello pesce



■ 10.5440.6060

**Austerngabel**

■ 12.5440.6040

141 mm/5 1/2 in.  
oyster fork  
fourchette à huîtres  
tenedor ostras  
forchetta per ostriche



■ 10.5464.6060

**Kuchengabel**

■ 12.5464.6040

157 mm/6 1/4 in.  
cake fork  
fourchette à gâteau  
tenedor lunch  
forchetta per dolce



■ 10.5466.6069

**Brot- /**

■ 12.5466.6049

170 mm/6 2/4 in.  
bread/butter knife\*\*  
couteau de table\*\*  
cuchillo lunch\*\*  
coltello per dolce\*\*



■ 10.5472.6060

**Limolöffel**

■ 12.5472.6040

220 mm/8 3/4 in.  
iced tea spoon  
cuiller à soda  
cuchara refresco  
cucchiaio bibita



■ 12.5478.6047

**Steakmesser\***

■ 12.5478.6049

222 mm/8 3/4 in.  
steak knife\*  
couteau à steak\*  
cuchillo steak\*  
coltello da bistecca\*



■ 12.5478.6049

**Steakmesser\*\***

■ 12.5478.6049

229 mm/9 in.  
steak knife\*\*  
couteau à steak\*\*  
cuchillo steak\*\*  
coltello da bistecca\*\*



■ 10.5489.6060

**Tassenlöffel**

■ 12.5489.6040

166 mm/6 1/2 in.  
round bowl soup spoon  
cuiller à bouillon  
cuchara sopa  
cucchiaio da brodo



VPE 12 Stk. / Unit 12 pcs.

■ perfekte Versilberung / perfectly silverplated

■ Cromargan®, poliert / stainless 18/10, polished

\* Hohlheft mit Wellenschliff / hollow-handled with serrated edge

\*\* Klingenstahl mit Wellenschliff / monobloc with serrated edge





■ **10 5400 6060**  
 perfekt versilbert  
 perfectly silverplated  
 chromage parfait  
 plateado perfecto  
 perfetta placcatura in argento

■ **12 5400 6040**  
 Cromargan®, poliert  
 Cromargan®, polished  
 Cromargan®, poli  
 Cromargan®, pulido  
 Cromargan®, lucido

Metropolitan bereichert klassische Gedecke mit seiner formvollendeten Silhouette. Die Wellenelemente an den Stielenden machen die Kollektion zum unverwechselbaren Begleiter unterschiedlichster Porzellanteile.

Metropolitan enhances classic table settings with its perfect silhouette. The wavy elements on the handle ends make this collection an unmistakable companion to all manner of porcelain items.

# METROPOLITAN

## 5400

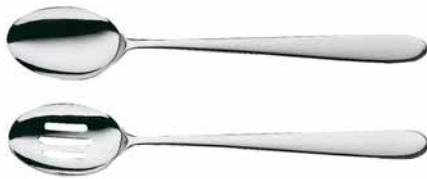

**Chafing Dish – Besteck**

chafing dish serving set  
service pour chafing dish  
cubierto servir chafing dish  
posate chafing dish

	Länge cm	length in.	Cromargan® stainless 18/10	versilbert silverplated
Chafing Dish Löffel / chafing dish spoon	39	15 1/4	<b>12.8387.6041</b>	<b>10.8387.6061*</b>
Chafing Dish Gabel / chafing dish fork	39	15 1/4	<b>12.8387.6042</b>	<b>10.8387.6062*</b>

\* VPE 12 Stk. / Unit 12 pcs.



**Salat-/Vorlegebesteck**

salad/buffet serving set  
couvert à salade/servir  
cubierto ensalada/servir  
posate servire insalata

	Länge cm	length in.	Cromargan® stainless 18/10	versilbert silverplated
Chafing Dish Löffel / chafing dish spoon	26	10 1/4	<b>12.8386.6041</b>	<b>10.8386.6061*</b>
Chafing Dish Gabel / chafing dish fork	26	10 1/4	<b>12.8386.6042</b>	
Chafing Dish Gabel / chafing dish fork	26	10 1/4	<b>12.8249.6040</b>	<b>10.8249.6060*</b>
Salatgabel / salad fork	26	10 1/4	<b>12.8343.6042</b>	<b>10.8343.6062*</b>

\* VPE 12 Stk. / Unit 12 pcs.



**Chafing Dish – Besteck**

chafing dish serving set  
service pour chafing dish  
cubierto servir chafing dish  
posate chafing dish

Hohlheftgriff /  
hollow-handled

Cromargan® / stainless 18/10

	Länge cm	length in.	
Chafing Dish Löffel / chafing dish spoon	32,5	12 3/4	<b>12.8381.6041</b>
Chafing Dish Gabel / chafing dish fork	32,5	12 3/4	<b>12.8381.6042</b>



**Fleischgabel**

serving fork  
fourchette à viande  
tenedor carne  
forchetta da antipasto

Hohlheftgriff /  
hollow-handled

Cromargan® / stainless 18/10

Länge cm	length in.	
32,5	12 3/4	<b>12.8382.6040</b>





### Nudellöffel

pasta serving spoon  
cuillère à spaghetti  
cuchara pasta  
cuchiaio per pasta

Hohlheftgriff /  
hollow-handled

Cromargan® / stainless 18/10

Länge	length
cm	in.
31,5	12 <sup>1</sup> / <sub>2</sub>

12.8383.6040



### Salatzange

salad serving tongs  
pince à salade  
pinza para ensalada  
pinza servire insalata

Länge	length
cm	in.
31	12 <sup>1</sup> / <sub>4</sub>

Cromargan®	versilbert
stainless 18/10	silverplated
12.8341.6040	10.8341.6060*

\* VPE 12 Stk. / Unit 12 pcs.



### Salatzange

salad serving tongs  
pince à salade  
pinza para ensalada  
pinza servire insalata

Cromargan® / stainless 18/10

Länge	length
cm	in.
30,5	12

12.8306.6040



### Universalzange Prof. Wagenfeld

pastry serving tongs  
pince à gâteau  
pinza pasteles  
pinza universale

Länge	length
cm	in.
20,5	8

Cromargan®	versilbert
mattiert	silverplated
stainless 18/10, satin finished	
12.8246.6030	10.8246.6060*

\* VPE 12 Stk. / Unit 12 pcs.



**Universalzange**

pastry serving tongs  
pince à gâteau  
pinza pasteles  
pinza universale

Cromargan® / stainless 18/10

Länge	length
cm	in.
23	9

54.9906.6040



**Eiszange**

ice tongs  
pince à glace  
pinza hielo  
pinza per ghiaccio

Länge	length
cm	in.
17,3	6 <sup>3</sup> / <sub>4</sub>

Cromargan®	versilbert
stainless 18/10	silverplated
<b>12.8307.6040</b>	<b>10.8307.6060*</b>

\* VPE 12 Stk. / Unit 12 pcs.



**Gebäck- und Servierzange**

pastry serving tongs  
pince à gâteau  
pinza pasteles  
pinza servire per dolci

Cromargan® teilmattiert / stainless 18/10 partly satin finished

Länge	length
cm	in.
17	6 <sup>3</sup> / <sub>4</sub>

12.8362.6040



**Zuckerzange**

sugar tongs  
pince à sucre  
pinza de azucar  
pinza per zucchero

Länge	length
cm	in.
10,7	4 <sup>1</sup> / <sub>4</sub>

Cromargan®	versilbert
stainless 18/10	silverplated
<b>12.8342.6040</b>	<b>10.8342.6060*</b>

\* VPE 12 Stk. / Unit 12 pcs.





### Hummergabel

lobster fork  
fourchette à homard  
tenedor bogavante  
forchetta aragosta

Länge	length
cm	in.
23,5	9 <sup>1</sup> / <sub>4</sub>

Cromargan®	versilbert
stainless 18/10	silverplated
<b>12.8336.6040</b>	<b>10.8336.6060*</b>

\* VPE 12 Stk. / Unit 12 pcs.



### Hummerzange

lobster-crack  
pince à homard  
pinza para langostas  
pinza per aragoste

Chromstahl / chrome steel

Länge	length
cm	in.
19,8	7 <sup>3</sup> / <sub>4</sub>

**12.8410.6040**



### Schneckengabel

snail fork  
fourchette à escargots  
tenedor caracoles  
forchetta per lumache

Länge	length
cm	in.
14,5	5 <sup>3</sup> / <sub>4</sub>

Cromargan®	versilbert
stainless 18/10	silverplated
<b>12.8335.6040</b>	<b>10.8335.6060*</b>

\* VPE 12 Stk. / Unit 12 pcs.



### Schneckenzange

snail tweezer  
pince à escargots  
pinza caracoles  
pinza per lumache

Cromargan® / stainless 18/10

Länge	length
cm	in.
15	6

**12.8291.6040**



**Dressinglöffel**

dressing ladle  
cuiller à sauce  
cazo salsa  
mestolino salsa

Cromargan® / stainless 18/10

Inhalt	cap.	Länge	length	Ø	Ø	
Ltr.	oz.	cm	in.	cm	in.	
0,03	1,05	26	10 <sup>1</sup> / <sub>4</sub>	6,5	2 <sup>1</sup> / <sub>2</sub>	12.8207.6040



**Bowlenlöffel**

punch bowl ladle  
cuiller à punch  
cazo ponche  
cucchiaio per bowl

Cromargan® / stainless 18/10

Inhalt	cap.	Länge	length	
Ltr.	oz.	cm	in.	
0,08	2,70	40	15 <sup>3</sup> / <sub>4</sub>	12.8344.6040



**Saucenlöffel**

gravy ladle  
cuiller à sauce  
cazo salsa  
mestolino salsa

Cromargan® / stainless 18/10

Inhalt	cap.	Länge	length	
Ltr.	oz.	cm	in.	
0,03	1,05	18	7	12.8395.6040



**Portionsschöpfer**

soup ladle, medium  
louche, medium  
cazo porciones  
ramaiolo, medio

Cromargan® / stainless 18/10

Inhalt	cap.	Länge	length	
Ltr.	oz.	cm	in.	
0,06	2,03	26,4	10 <sup>1</sup> / <sub>2</sub>	12.8423.6040



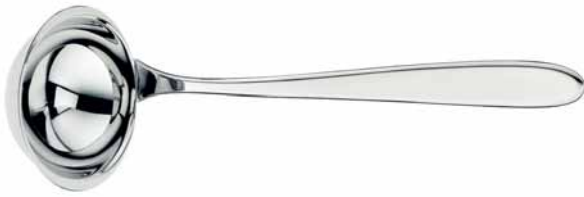

### Suppenschöpfer

soup ladle  
louche à potage  
cazo sopa  
ramaiole

Cromargan® / stainless 18/10

Inhalt	cap.	Länge	length
Ltr.	oz.	cm	in.
0,11	3,72	29,5	11 1/2

54.9904.6040



### Kartoffellöffel

potato spoon  
cuiller à pommes de terre  
cucharon patatas  
cucchiaio per patate

Cromargan® / stainless 18/10

Länge	length
cm	in.
21,5	8 1/2

12.8394.6040



### Eisschaufel

ice-shovel  
cuiller à glace  
pala para hielo  
cucchianino per gelato

Cromargan® / stainless 18/10

Länge	length
cm	in.
13,8	5 1/2

12.8057.6040\*

\* VPE 12 Stk. / unit 12 pcs.



### Eierlöffel

egg spoon  
cuiller à oeuf  
cuchara huevos  
cucchiaio per uovo

Cromargan® / stainless 18/10

Länge	length
cm	in.
13	5

12.9008.6040\*

\* VPE 12 Stk. / unit 12 pcs.



**Vorlege-/ Aufschnittgabel**

serving fork  
fourchette à viande  
tenedor carne  
forchetta da antipasto

Cromargan® / stainless 18/10

Länge	length
cm	in.
19	7½

12.8393.6040



**Brotmesser  
GRAND GOURMET**

bread knife  
couteau à pain  
cuchillo pan  
coltello pane

Spezialklingenstahl, Cromargan® /  
special blade steel, stainless 18/10

Länge	length
cm	in.
32	12½

18.8950.6032



**Brotmesser  
SPITZENKLASSE PLUS**

bread knife  
couteau à pain  
cuchillo pan  
coltello pane

Spezialklingenstahl, Cromargan® /  
special blade steel, stainless 18/10

Länge	length
cm	in.
31,5	12½

18.8976.6032



**Tranchiermesser  
GRAND GOURMET**

carving knife  
couteau à viande  
cuchillo carne  
coltello carne

Spezialklingenstahl, Cromargan® /  
special blade steel, stainless 18/10

Gesamtlänge	total length	Klingenlänge	length of blade
cm	in.	cm	in.
32,5	12¾	20	8

18.8948.6032





**Tranchiergabel  
GRAND GOURMET**

meat fork  
fourchette à viande  
tenedor carne  
forchettone

Cromargan® / stainless 18/10

Gesamtlänge cm	total length in.	Klingenlänge cm	length of blade in.
29	11 <sup>1</sup> / <sub>2</sub>	14	5 <sup>1</sup> / <sub>2</sub>

**18.8957.6030**



**Tranchiermesser  
SPITZENKLASSE PLUS**

carving knife  
couteau à viande  
cuchillo carne  
coltello carne

Spezialklingenstahl, Cromargan® /  
special blade steel, stainless 18/10

Gesamtlänge cm	total length in.	Klingenlänge cm	length of blade in.
32	12 <sup>1</sup> / <sub>2</sub>	20	8

**18.9582.6032**



**Tranchiergabel  
SPITZENKLASSE PLUS**

meat fork  
fourchette à viande  
tenedor carne  
forchettone

Spezialklingenstahl, Cromargan® /  
special blade steel, stainless 18/10

Gesamtlänge cm	total length in.	Klingenlänge cm	length of blade in.
27	10 <sup>3</sup> / <sub>4</sub>	12	4 <sup>3</sup> / <sub>4</sub>

**18.9588.6031**



**Steakbesteck SOLID**

steak fork and knife SOLID  
couvert à steak SOLID  
cubierto steak SOLID  
posate da bistecca SOLID

Cromargan® / stainless 18/10

	Länge cm	length in.	
Steakgabel SOLID / steak fork SOLID	21	8 <sup>1</sup> / <sub>4</sub>	<b>12.9013.6040</b>
Steakmesser SOLID* / steak knife SOLID*	24,4	9 <sup>3</sup> / <sub>4</sub>	<b>12.9014.6040*</b>

\* Hohlheft mit Wellenschliff / hollow-handled with serrated edge



**Steakbesteck**

steak flatware  
couvert à steak  
cubierto steak  
posate da bistecca

Cromargan® / stainless 18/10

	Länge cm	length in.	
Steakgabel / steak fork	21	8 <sup>1</sup> / <sub>4</sub>	12.8960.6042
Steakmesser / steak knife	23,1	9	12.8960.6049



**Steakmesser**

steak knife  
couteau à steak  
cuchillo steak  
coltello da bistecca

Cromargan® / stainless 18/10

Länge cm	length in.	
20	8	12.8705.6047



**Steakmesser\***

steak knife\*  
couteau à steak\*  
cuchillo steak\*  
coltello da bistecca\*

Cromargan®, poliert / stainless 18/10, polished

Länge mm	length in.	
220	8 <sup>3</sup> / <sub>4</sub>	11.0178.6047

\* Hohlheft mit Wellenschliff / hollow-handled with serrated edge



**Kaviarlöffel**

caviar spoon  
cuiller à caviar  
cuchara caviar  
cucchiaio per caviale

versilbert / silverplated

Länge cm	length in.	
20	8	01.0195.6062*

\* VPE 12 Stk. / unit 12 pcs.





### Kaviarmesser

caviar knife  
couteau à caviar  
cuchillo caviar  
coltellino per caviale

versilbert / silverplated

Länge	length
cm	in.
21	8 <sup>1</sup> / <sub>4</sub>

01.0195.6063\*

\* VPE 12 Stk. / unit 12 pcs.



### Happy Spoon

happy spoon  
happy spoon  
happy spoon  
happy spoon

in Menue- und Vorspeisengröße! /  
in size table and dessert spoon!

Cromargan® / stainless 18/10

	Länge cm	length in.	
Happy Spoon	12,5	5	12.8993.6040
Happy Spoon S	11,5	4 <sup>1</sup> / <sub>2</sub>	12.8345.6040

\* VPE 12 Stk. / unit 12 pcs.



### Tortenheber

pie server, large  
pelle à gâteau, grande  
pala tarta, grande  
pala da torta, grande

Länge	length
cm	in.
26	10 <sup>1</sup> / <sub>4</sub>

Cromargan®	versilbert
stainless 18/10	silverplated
12.8424.6040	10.8424.6060*

\* VPE 12 Stk. / Unit 12 pcs.



### Tortenmesser

cake knife  
couteau à tarte  
cuchillo tarta  
coltello torta

Cromargan® / stainless 18/10

Länge	length
cm	in.
28	11

12.9163.6040



**Käsemesser**

cheese knife  
couteau à fromage  
cuchillo queso  
coltello formaggio

Cromargan® / stainless 18/10

Länge	length
cm	in.
22	8 <sup>3</sup> / <sub>4</sub>

12.8861.6041



**"4 for you" - Löffel**

"4 for you" spoon  
cuiller "4 for you"  
cuchara "4 for you"  
cucchiaio "4 for you"

Chromstahl / chrome steel

	Länge cm	length in.	
Gewürzlöffel (VPE 12 Stk.) / spicy spoon (unit 12 pcs.)	7	2 <sup>3</sup> / <sub>4</sub>	54.9184.6040
Espressolöffel / demi-tasse spoon	10,5	4 <sup>1</sup> / <sub>4</sub>	12.9185.6040
Kaffeelöffel / coffee spoon	13,5	5 <sup>1</sup> / <sub>4</sub>	12.9186.6040
Eiskaffeelöffel / iced tea spoon	19,5	7 <sup>1</sup> / <sub>2</sub>	12.9188.6040

\* VPE 12 Stk. / unit 12 pcs.



**Löffel „KaffeeKultur“**

spoons „KaffeeKultur“  
cuillers „KaffeeKultur“  
cucharas „KaffeeKultur“  
cucchiai „KaffeeKultur“

Cromargan® / stainless 18/10

Länge	length
mm	in.
110	4 <sup>1</sup> / <sub>4</sub>
136	5 <sup>1</sup> / <sub>4</sub>
157	6 <sup>1</sup> / <sub>4</sub>

54.9901.6040

54.9902.6040

54.9903.6040

\* VPE 12 Stk. / unit 12 pcs.



**Eislöffel XL**

ice spoon XL  
cuiller à glace XL  
pala para hielo XL  
cucchianino per gelato XL

Cromargan® / stainless 18/10

Länge	length
mm	in.
180	7

54.9905.6040\*

\* VPE 12 Stk. / unit 12 pcs.





### Ess-Stäbchen Paar

#### ASIA

chopsticks pair  
baguettes paire  
juego de palillos  
paio bacchette

Cromargan®, POM Kunststoff / stainless 18/10, plastic

Länge	length
cm	in.
25,4	10

55.0122.6040



### Ess-Stäbchen Ablage

#### ASIA

chopstick stand  
rangement pour baguettes  
soporte para palillos  
portaoggetti per bacchette

Cromargan® / stainless 18/10

Größe	size
cm	in.
8,4 x 1,7 x 1	3 1/4 x 3/4 x 1/2

55.0123.6040



### Ess-Stäbchen Set

#### ASIA

chopstick set  
kit baguettes  
juego palillos  
set bacchette

bestehend aus: Ess-Stäbchen Paar, Ess-Stäbchen Ablage und  
Menselöffel Nordic /  
consisting of: chopstick pair, chopstick stand and table spoon Nordic

Cromargan®, POM Kunststoff / stainless 18/10, plastic

Ess-Stäbchen Paar / chopsticks pair

Länge	length
cm	in.
25,4	10

55.0122.6040

Ess-Stäbchen Ablage / chopstick stand

Größe	size
cm	in.
8,4 x 1,7 x 1	3 1/4 x 3/4 x 1/2

55.0123.6040

Menselöffel / table spoon

54.7201.6040

\* Artikel einzeln zu bestellen / please order articles separately

# Der perfekte Look mit starkem Charakter.

The perfect look with a strong character.

Mit innovativen Formen der Veredelung wird ein außergewöhnliches, starkes Design geschaffen. Die neu interpretierten Materialoberflächen mit den unterschiedlichsten Veredelungsarten setzen Ihr Besteck gekonnt in Szene.

Besondere Stilelemente werden durch die Varianten Stone-Washed, Glasperle und PVD erzeugt. Sie eignen sich für alle Modelle aus Cromargan®, sind spülmaschinenfest und schaffen ein besonderes Ambiente.

Die Möglichkeiten sind vielfältig und werden individuell angefertigt, dabei können die Veredelungen Produkten leicht das besondere Etwas verleihen. Der Kreativität sind keine Grenzen gesetzt. Informationen zu Stückzahlen, Preisen und Lieferzeiten erhalten Sie auf Anfrage.

This innovative form of refinement creates an extraordinary design. The re-interpreted material surfaces of our cutlery models with special forms of refinement skillfully draw attention.

Special stylistic highlights can be created by the variants Stone-washed, Glass bead and PVD. Those finishes are dishwasher-safe and suitable for all Cromargan® models.

The possibilities are diverse and customised to suit your individual requirements. The magic is able to turn regular products into eye-catching highlights. Creativity has no limits. Therefore, detailed information about order volume, prices and delivery time is available on request.



## **PVD. Extraschicht für edle Optik.**

Farbklänge von Gold, Hellgold, Anthrazit und Kupfer verfeinern das Ambiente. Schicht für Schicht werden die lebensmittelechten, metallischen Farben im Vakuumverfahren aufgetragen.

Diese besondere Art der Veredelung ist für alle WMF Cromargan® Besteckmodelle geeignet. Hohlheft-Messer sind aus technischen Gründen von der Beschichtung ausgenommen. PVD, der Stoff aus dem die dekorativen Oberflächen-Verwandlungen sind, kommt übrigens ursprünglich aus der Schmuckindustrie.

## **PVD. Laid on additionally for quality good looks.**

Colors of gold, light gold, anthracite and copper enhance the ambiance. The food-safe, metallic colors are applied layer by layer in the process known as physical vapour deposition, PVD.

This noble kind of refinement are suitable for all WMF Cromargan® cutlery models. However, hollow-handle knives are excluded from the PVD process due to technical reasons. PVD, the technique that produces these decorative surface alterations, was originally developed for the jewelry industry.



PVD Gold  
PVD Gold

PVD Kupfer  
PVD Copper





**Stone-Washed. Steingewaschene Unikate.**

Dieser imposante Vintage-Charakter wirkt insbesondere mit rustikalem Porzellan. Jedes Besteck, dass sich dem Stone-Washing unterzogen hat, ist ein Unikat für sich. Der besondere unregelmäßige Materialabtrag entsteht durch Schleifkörper, die seine Metalloberfläche wie kleine Feilen bearbeitet. Somit gleicht kein Besteckteil dem anderen und wird durch den „Used“ – oder auch Antik-Look zu einem tollen Blickfang.

**Stone-washing. Stone-tumbled singularities.**

This imposing vintage character is especially effective in combination with rustic porcelain. Every cutlery is unique. The effect of irregular abrasion is formed by tumbler stones, acting on the surface of the metal like tiny files. Therefore, no two pieces are exactly alike. The characteristic 'distressed' or 'aged' look are great eye-catcher.

**Glasperle. Samtige Glanz- und Berührungspunkte.**

Eine zarte, seidenmatten Nuance wird durch die Behandlung mit Glasperlenstrahlen erzeugt. Hierbei werden kleine Glaskugeln mit Hochdruck auf die Besteckteile geblasen. Diese besonders feine Form der Veredelung verleiht Bestecken eine angenehm glatte Oberfläche und ein schimmerndes, gleichmäßiges Erscheinungsbild.

**Glass bead. Velvety highlights and points of contact.**

The treatment using glass bead blasting adds a delicate, silk matt touch to the cutlery and table accessories. Hereby, small glass beads are blown under pressure on each cutlery. This extra delicate technique of finishing affords a uniform lustrous appearance.



Glasperlengestrahlt  
Glass bead blasted

Stone-Washed  
stone-washed

versilbert/poliert  
silverplated/polished

PVD Anthrazit  
PVD Anthracite

PVD Hellgold  
PVD Light gold

# Table Top

table top





# Tradition. Design. Kompetenz.

## Tradition. Design. Competence.

### **Für die glänzenden Momente.**

Klarheit, Qualität und feinste Verarbeitung. Wie kein anderes Produkt wird unser formvollendetes Glaswerk diesen Ansprüchen gerecht. Ausnahmslos wird eine gedeckte Tafel erst durch die perfekte Glasauswahl zu einem einzigartigen Blickfang und einem unverkennbaren Genusserlebnis.

WMF Firstglass zeichnet sich neben seiner bruch- und spülfesten Beschaffenheit, durch sein gleichwohl brillantes Erscheinungsbild aus. Jedes einzelne Glas, mit seiner weich geschwungenen Glas-Architektur, erfüllt seine besondere Funktion und bringt jedes Getränk glänzend zur Geltung. Das Glas wird aus einem einzigen Stück gefertigt, somit wird ein nahtloser Übergang zwischen Stiel und Oberteil erzielt. Aufgrund ihrer Leichtigkeit und dennoch robusten Form eignen sich die Gläser für den anspruchsvollen gastronomischen Alltag.

Wir bieten Ihnen eine umfangreiche Auswahl an klar aufeinander abgestimmten Kollektionen, welche Ihre Bedürfnisse wunschlos erfüllen.

### **For the shiny moments.**

Clarity, quality and finest workmanship. Our perfectly shaped glasswork meets these requirements like no other product. Without any exception, a laid table only turns into an unique eye-catcher and an unmistakable gourmet experience by a fine selection of glasses.

WMF Firstglass distinguishes itself: in addition to its break-proof quality and its dishwasher safety, particularly by its brilliant appearance. Each individual glass fulfills its special feature with its softly curved glass architecture and emphasizes the strengths and advantageous of every beverage. Our glasses, which are crafted out of a single piece of glass and which are characterized by a seamless transition between the stem and the top, are perfectly suited for the challenging daily routines of gastronomy, thanks to their lightness and still resilient design.

We offer an extensive selection of well-defined and harmonized collections, which fully meet your needs.





# DIVINE COLOR



NEU NEW

**Bunt, einzigartig und unverwechselbar.**

Diese Eigenschaften bringen unsere diesjährigen Neuheiten mit sich. Unsere Wassergläser bieten wir in vier trendigen und modernen Farben an – rauchblau, rauchgrau, bernstein und oliv.

**Colorful, unique and unmistakable.**

Our this year's novelties entail all these characteristics. The tumblers are available in four trendy and modern colors – smoky blue, smoky gray, amber and olive.







**Burgunder 99**  
**DIVINE**

Burgundy 99  
Bourgogne 99  
Borgoña 99  
Borgogna 99

Inhalt	cap.	Höhe	height	Ø	Ø	VPE/PU	PAL
Ltr.	oz.	cm	in.	cm	in.	Stk/pcs.	Stk/pcs.
0,695	23,5	23,1	9	10,7	4 1/4	6	264

ungeeicht / uncalibrated **58.0050.0099**  
 geeicht 0,2l / calibrated 0,2l **58.0050.0299**  
 Spülkorbempfehlung / washing rack recommendation **58.4608.5005**



**Bordeaux 35**  
**DIVINE**

Bordeaux 35  
Bordeaux 35  
Bordeaux 35  
Bordeaux 35

Inhalt	cap.	Höhe	height	Ø	Ø	VPE/PU	PAL
Ltr.	oz.	cm	in.	cm	in.	Stk/pcs.	Stk/pcs.
0,645	21,8	23,8	9 1/4	9,5	3 3/4	6	288

ungeeicht / uncalibrated **58.0050.0035**  
 geeicht 0,2l / calibrated 0,2l **58.0050.0235**  
 Spülkorbempfehlung / washing rack recommendation **58.4608.5005**



**Rotweinkelch 01**  
**DIVINE**

Red Wine Goblet 01  
Coupe de vin rouge 01  
Copa de vino tinto 01  
Calice da vino rosso 01

Inhalt	cap.	Höhe	height	Ø	Ø	VPE/PU	PAL
Ltr.	oz.	cm	in.	cm	in.	Stk/pcs.	Stk/pcs.
0,450	15,2	22,5	9	8,4	3 1/4	6	456

ungeeicht / uncalibrated **58.0050.0001**  
 geeicht 0,2l / calibrated 0,2l **58.0050.0201**  
 Spülkorbempfehlung / washing rack recommendation **58.4608.5012**



**Weissweinkelch 02**  
**DIVINE**

White Wine Goblet 02  
Coupe de vin blanc 02  
Copa de vino blanco 02  
Calice da vino bianco 02

Inhalt	cap.	Höhe	height	Ø	Ø	VPE/PU	PAL
Ltr.	oz.	cm	in.	cm	in.	Stk/pcs.	Stk/pcs.
0,350	11,8	21,4	8 1/2	8,0	3 1/4	6	504

ungeeicht / uncalibrated **58.0050.0002**  
 geeicht 0,1l / calibrated 0,1l **58.0050.0102**  
 geeicht 0,2l / calibrated 0,2l **58.0050.0202**  
 Spülkorbempfehlung / washing rack recommendation **58.4608.5012**



### Champagner 29

#### DIVINE

Champagne 29

Champagne 29

Champán 29

Flûte 29

Inhalt	cap.	Höhe	height	Ø	Ø	VPE/PU	PAL
Ltr.	oz.	cm	in.	cm	in.	Stk/pcs.	Stk/pcs.
0,265	9	22,3	8 <sup>3</sup> / <sub>4</sub>	7,0	2 <sup>3</sup> / <sub>4</sub>	6	624

ungeeicht / uncalibrated

58.0050.0029

geeicht 0,1l / calibrated 0,1l

58.0050.0129

Spülkorbempfehlung / washing rack recommendation

58.4608.5019



### Sektkelch 07

#### DIVINE

Flute Champagne 07

Coupe de champagne 07

Copa de vino espumoso 07

Calice da spumante 07

Inhalt	cap.	Höhe	height	Ø	Ø	VPE/PU	PAL
Ltr.	oz.	cm	in.	cm	in.	Stk/pcs.	Stk/pcs.
0,188	6,4	22,4	8 <sup>3</sup> / <sub>4</sub>	6,3	2 <sup>1</sup> / <sub>2</sub>	6	624

ungeeicht / uncalibrated

58.0050.0007

geeicht 0,1l / calibrated 0,1l

58.0050.0107

Spülkorbempfehlung / washing rack recommendation

58.4608.5019



### Sherry/Digestif 04

#### DIVINE

Sherry/Digestive 04

Xérès/digestif 04

Jerez/digestivo 04

Sherry/digestivo 04

Inhalt	cap.	Höhe	height	Ø	Ø	VPE/PU	PAL
Ltr.	oz.	cm	in.	cm	in.	Stk/pcs.	Stk/pcs.
0,190	6,4	20,0	8	6,6	2 <sup>1</sup> / <sub>2</sub>	6	624

ungeeicht / uncalibrated

58.0050.0004

Spülkorbempfehlung / washing rack recommendation

58.4608.5018



### Mixdrink 09

#### DIVINE

Mixdrink 09

Boisson mélangée 09

Combinado 09

Mixdrink 09

Inhalt	cap.	Höhe	height	Ø	Ø	VPE/PU	PAL
Ltr.	oz.	cm	in.	cm	in.	Stk/pcs.	Stk/pcs.
0,361	12,2	14,2	5 <sup>1</sup> / <sub>2</sub>	6,8	2 <sup>3</sup> / <sub>4</sub>	6	1044

ungeeicht / uncalibrated

58.0050.0009

geeicht 0,25l / calibrated 0,25l

58.0050.0309

Spülkorbempfehlung / washing rack recommendation

58.4608.5017





**Tumbler 15**

**DIVINE**

Tumbler 15  
 Tumbler 15  
 Vaso tubo 15  
 Tumbler 15

Inhalt Ltr.	cap. oz.	Höhe cm	height in.	Ø cm	Ø in.	VPE/PU Stk/pcs.	PAL Stk/pcs.
0,325	11,0	10,2	4	8,0	3 1/4	6	912

ungeeicht / uncalibrated

**58.0050.0015**

Spülkorbempfehlung / washing rack recommendation

**58.4608.5009**



**Softdrink 14**

**DIVINE**

Softdrink 14  
 Boisson sans alcool 14  
 Refresco 14  
 Softdrink 14

Inhalt Ltr.	cap. oz.	Höhe cm	height in.	Ø cm	Ø in.	VPE/PU Stk/pcs.	PAL Stk/pcs.
0,225	7,6	9,2	3 1/2	7,6	3	6	1296

ungeeicht / uncalibrated

**58.0050.0014**

geeicht 0,2l / calibrated 0,2l

**58.0050.0214**

Spülkorbempfehlung / washing rack recommendation

**58.4608.5009**



**Minibar 47**

**DIVINE**

Minibar 47  
 Minibar 47  
 Minibar 47  
 Minibar 47

Inhalt Ltr.	cap. oz.	Höhe cm	height in.	Ø cm	Ø in.	VPE/PU Stk/pcs.	PAL Stk/pcs.
0,150	5,1	8,0	3 1/4	6,4	2 1/2	6	1860

ungeeicht / uncalibrated

**58.0050.0047**

Spülkorbempfehlung / washing rack recommendation

**58.4608.5015**

**Burgunder 99****ROYAL**

Burgundy 99

Bourgogne 99

Borgoña 99

Borgogna 99

Inhalt	cap.	Höhe	height	Ø	Ø	VPE/PU	PAL
Ltr.	oz.	cm	in.	cm	in.	Stk/pcs.	Stk/pcs.
0,705	23,8	23,5	9 <sup>1</sup> / <sub>4</sub>	10,2	4	6	216

ungeeicht / uncalibrated

**58.0010.0099**

geeicht 0,2l / calibrated 0,2l

**58.0010.0299**

Spülkorbempfehlung / washing rack recommendation

**58.4608.5005****Bordeaux 35****ROYAL**

Bordeaux 35

Bordeaux 35

Bordeaux 35

Bordeaux 35

Inhalt	cap.	Höhe	height	Ø	Ø	VPE/PU	PAL
Ltr.	oz.	cm	in.	cm	in.	Stk/pcs.	Stk/pcs.
0,635	21,5	23,9	9 <sup>1</sup> / <sub>2</sub>	9,5	3 <sup>3</sup> / <sub>4</sub>	6	288

ungeeicht / uncalibrated

**58.0010.0035**

geeicht 0,2l / calibrated 0,2l

**58.0010.0235**

Spülkorbempfehlung / washing rack recommendation

**58.4608.5005****Rotweinkelch 01****ROYAL**

Red Wine Goblet 01

Coupe de vin rouge 01

Copa de vino tinto 01

Calice da vino rosso 01

Inhalt	cap.	Höhe	height	Ø	Ø	VPE/PU	PAL
Ltr.	oz.	cm	in.	cm	in.	Stk/pcs.	Stk/pcs.
0,450	15,2	22,4	8 <sup>3</sup> / <sub>4</sub>	8,5	3 <sup>1</sup> / <sub>4</sub>	6	456

ungeeicht / uncalibrated

**58.0010.0001**

geeicht 0,2l / calibrated 0,2l

**58.0010.0201**

Spülkorbempfehlung / washing rack recommendation

**58.4608.5012****Weissweinkelch 02****ROYAL**

White Wine Goblet 02

Coupe de vin blanc 02

Copa de vino blanco 02

Calice da vino bianco 02

Inhalt	cap.	Höhe	height	Ø	Ø	VPE/PU	PAL
Ltr.	oz.	cm	in.	cm	in.	Stk/pcs.	Stk/pcs.
0,390	13,2	21,2	8 <sup>1</sup> / <sub>4</sub>	8,1	3 <sup>1</sup> / <sub>4</sub>	6	504

ungeeicht / uncalibrated

**58.0010.0002**

geeicht 0,1l / calibrated 0,1l

**58.0010.0102**

geeicht 0,2l / calibrated 0,2l

**58.0010.0202**

Spülkorbempfehlung / washing rack recommendation

**58.4608.5012**

**Champagner 29****ROYAL**

Champagne 29

Champagne 29

Champán 29

Flûte 29

Inhalt	cap.	Höhe	height	Ø	Ø	VPE/PU	PAL
Ltr.	oz.	cm	in.	cm	in.	Stk/pcs.	Stk/pcs.
0,250	8,5	21,6	8½	6,5	2½	6	624

ungeeicht / uncalibrated

**58.0010.0029**

geeicht 0,1l / calibrated 0,1l

**58.0010.0129**

Spülkorbempfehlung / washing rack recommendation

**58.4608.5019****Sherry/Portwein 04****ROYAL**

Sherry/Port 04

Xérès/porto 04

Jerez/vino de Oporto 04

Sherry/Porto 04

Inhalt	cap.	Höhe	height	Ø	Ø	VPE/PU	PAL
Ltr.	oz.	cm	in.	cm	in.	Stk/pcs.	Stk/pcs.
0,180	6,1	17,3	6¾	6,5	2½	6	750

ungeeicht / uncalibrated

**58.0010.0004**

Spülkorbempfehlung / washing rack recommendation

**58.4608.5018****Destillat 30****ROYAL**

Destillate 30

Distillat 30

Destilado 30

Distillati 30

Inhalt	cap.	Höhe	height	Ø	Ø	VPE/PU	PAL
Ltr.	oz.	cm	in.	cm	in.	Stk/pcs.	Stk/pcs.
0,095	3,2	17,3	6¾	5,5	2¼	6	1080

ungeeicht / uncalibrated

**58.0010.0030**

Spülkorbempfehlung / washing rack recommendation

**58.4608.5018****Digestif 23****ROYAL**

Digestive 23

Digestif 23

Digestivo 23

Digestivo 23

Inhalt	cap.	Höhe	height	Ø	Ø	VPE/PU	PAL
Ltr.	oz.	cm	in.	cm	in.	Stk/pcs.	Stk/pcs.
0,104	3,5	16,9	6¾	5,6	2¼	6	1080

ungeeicht / uncalibrated

**58.0010.0023**

Spülkorbempfehlung / washing rack recommendation

**58.4608.5018**





**Cognac 18**  
**ROYAL**

Brandy Glass 18  
Cognac 18  
Coñac 18  
Cognac 18

Inhalt	cap.	Höhe	height	Ø	Ø	VPE/PU	PAL
Ltr.	oz.	cm	in.	cm	in.	Stk/pcs.	Stk/pcs.
0,610	20,6	15,5	6	10,4	4	6	330

ungeeicht / uncalibrated

**58.0010.0018**

Spülkorbempfehlung / washing rack recommendation

**58.4608.5003**



**Bier-/Wasserglas 11**  
**ROYAL**

Beer/Mineral Water Glass 11  
Verre à bière/eau 11  
Vaso para cerveza/agua 11  
Bicchieri acqua/birra 11

Inhalt	cap.	Höhe	height	Ø	Ø	VPE/PU	PAL
Ltr.	oz.	cm	in.	cm	in.	Stk/pcs.	Stk/pcs.
0,410	13,9	16,1	6 <sup>1</sup> / <sub>4</sub>	8,1	3 <sup>1</sup> / <sub>4</sub>	6	570

ungeeicht / uncalibrated

**58.0010.0011**

geeicht 0,3l / calibrated 0,3l

**58.0010.0411**

Spülkorbempfehlung / washing rack recommendation

**58.4608.5010**



**Martini 25**  
**ROYAL**

Martini 25  
Martini 25  
Martini 25  
Martini 25

Inhalt	cap.	Höhe	height	Ø	Ø	VPE/PU	PAL
Ltr.	oz.	cm	in.	cm	in.	Stk/pcs.	Stk/pcs.
0,240	8,1	17,2	6 <sup>3</sup> / <sub>4</sub>	11,6	4 <sup>1</sup> / <sub>2</sub>	6	270

ungeeicht / Martini 25 uncalibrated

**58.0010.0025**

Spülkorbempfehlung / washing rack recommendation

**58.4608.5025**



**Bordeaux 35**

**SMART**

Bordeaux 35  
 Bordeaux 35  
 Burdeos 35  
 Bordeaux 35

Inhalt	cap.	Höhe	height	Ø	Ø	VPE/PU	PAL
Ltr.	oz.	cm	in.	cm	in.	Stk/pcs.	Stk/pcs.
0,650	22,0	22,7	9	9,5	3 <sup>3</sup> / <sub>4</sub>	6	288

ungeeicht / uncalibrated 58.0020.0035

geeicht 0,2l / calibrated 0,2l 58.0020.0235

Spülkorbempfehlung / washing rack recommendation 58.4608.5005



**Rotweinkelch 01**

**SMART**

Red Wine Goblet 01  
 Coupe de vin rouge 01  
 Copa de vino tinto 01  
 Calice da vino rosso 01

Inhalt	cap.	Höhe	height	Ø	Ø	VPE/PU	PAL
Ltr.	oz.	cm	in.	cm	in.	Stk/pcs.	Stk/pcs.
0,500	16,9	21,9	8 <sup>1</sup> / <sub>2</sub>	8,7	3 <sup>1</sup> / <sub>2</sub>	6	456

ungeeicht / uncalibrated 58.0020.0001

geeicht 0,2l / calibrated 0,2l 58.0020.0201

Spülkorbempfehlung / washing rack recommendation 58.4608.5012



**Weissweinkelch 02**

**SMART**

White Wine Goblet 02  
 Coupe de vin blanc 02  
 Copa de vino blanco 02  
 Calice da vino bianco 02

Inhalt	cap.	Höhe	height	Ø	Ø	VPE/PU	PAL
Ltr.	oz.	cm	in.	cm	in.	Stk/pcs.	Stk/pcs.
0,387	13,1	21,0	8 <sup>1</sup> / <sub>4</sub>	7,9	2 <sup>3</sup> / <sub>4</sub>	6	504

ungeeicht / uncalibrated 58.0020.0002

geeicht 0,1l / calibrated 0,1l 58.0020.0102

geeicht 0,2l / calibrated 0,2l 58.0020.0202

Spülkorbempfehlung / washing rack recommendation 58.4608.5012



**Champagner 29**

**SMART**

Champagne 29  
 Champagne 29  
 Champán 29  
 Flûte 29

Inhalt	cap.	Höhe	height	Ø	Ø	VPE/PU	PAL
Ltr.	oz.	cm	in.	cm	in.	Stk/pcs.	Stk/pcs.
0,210	7,1	20,5	8	6,8	2 <sup>3</sup> / <sub>4</sub>	6	624

ungeeicht / uncalibrated 58.0020.0029

geeicht 0,1l / calibrated 0,1l 58.0020.0129

Spülkorbempfehlung / washing rack recommendation 58.4608.5019



### Sektkelch 07

#### SMART

Flute Champagne 07  
 Coupe de champagne 07  
 Copa de vino espumoso 07  
 Calice da spumante 07

Inhalt	cap.	Höhe	height	Ø	Ø	VPE/PU	PAL
Ltr.	oz.	cm	in.	cm	in.	Stk/pcs.	Stk/pcs.
0,170	5,7	22,4	8 <sup>3</sup> / <sub>4</sub>	6,5	2 <sup>1</sup> / <sub>2</sub>	6	624

ungeeicht / uncalibrated

**58.0020.0007**

geeicht 0,1l / calibrated 0,1l

**58.0020.0107**

Spülkorbempfehlung / washing rack recommendation

**58.4608.5019**



### Tasting/Dessertwein 04

#### SMART

Tasting/dessert wine 04  
 Dégustation/vin de dessert 04  
 Cata/vino dulce 04  
 Tasting/vino da dessert 04

Inhalt	cap.	Höhe	height	Ø	Ø	VPE/PU	PAL
Ltr.	oz.	cm	in.	cm	in.	Stk/pcs.	Stk/pcs.
0,290	9,8	18,5	7 <sup>1</sup> / <sub>4</sub>	7,3	2 <sup>3</sup> / <sub>4</sub>	6	504

ungeeicht / uncalibrated

**58.0020.0004**

Spülkorbempfehlung / washing rack recommendation

**58.4608.5018**



### Wasser-/Minibarglas 10

#### SMART

Mineral Water/Minibar 10  
 Verre à eau/minibar 10  
 Vaso para agua/minibar 10  
 Bicchiere acqua/minibar 10

Inhalt	cap.	Höhe	height	Ø	Ø	VPE/PU	PAL
Ltr.	oz.	cm	in.	cm	in.	Stk/pcs.	Stk/pcs.
0,387	13,1	17,5	7	7,9	3	6	750

ungeeicht / uncalibrated

**58.0020.0010**

geeicht 0,2l / calibrated 0,2l

**58.0020.0210**

Spülkorbempfehlung / washing rack recommendation

**58.4608.5011**





**Tumbler XL 16  
MANHATTAN**

Tumbler XL 16  
Tumbler XL 16  
Vaso tubo XL 16  
Tumbler XL 16

Inhalt	cap.	Höhe	height	Ø	Ø	VPE/PU	PAL
Ltr.	oz.	cm	in.	cm	in.	Stk/pcs.	Stk/pcs.
0,420	14,2	10,6	4 <sup>1</sup> / <sub>4</sub>	8,5	3 <sup>1</sup> / <sub>4</sub>	6	672

ungeeicht / uncalibrated

58.0030.0016

Spülkorbempfehlung / washing rack recommendation

58.4608.5009



**Tumbler 15  
MANHATTAN**

Tumbler 15  
Tumbler 15  
Vaso tubo 15  
Tumbler 15

Inhalt	cap.	Höhe	height	Ø	Ø	VPE/PU	PAL
Ltr.	oz.	cm	in.	cm	in.	Stk/pcs.	Stk/pcs.
0,320	10,8	9,4	3 <sup>3</sup> / <sub>4</sub>	8,0	3 <sup>1</sup> / <sub>4</sub>	6	1026

ungeeicht / uncalibrated

58.0030.0015

Spülkorbempfehlung / washing rack recommendation

58.4608.5009



**Minibar 47  
MANHATTAN**

Minibar 47  
Minibar 47  
Minibar 47  
Minibar 47

Inhalt	cap.	Höhe	height	Ø	Ø	VPE/PU	PAL
Ltr.	oz.	cm	in.	cm	in.	Stk/pcs.	Stk/pcs.
0,190	6,4	8,0	3 <sup>1</sup> / <sub>4</sub>	6,7	2 <sup>3</sup> / <sub>4</sub>	6	1740

ungeeicht / uncalibrated

58.0030.0047

Spülkorbempfehlung / washing rack recommendation

58.4608.5015



**Short 20  
MANHATTAN**

Shot 20  
Short 20  
Copa pequeña 20  
Short 20

Inhalt	cap.	Höhe	height	Ø	Ø	VPE/PU	PAL
Ltr.	oz.	cm	in.	cm	in.	Stk/pcs.	Stk/pcs.
0,057	1,9	8,1	3 <sup>1</sup> / <sub>4</sub>	3,9	1 <sup>1</sup> / <sub>2</sub>	6	4320

ungeeicht / uncalibrated

58.0030.0020

Spülkorbempfehlung / washing rack recommendation

58.4608.5029



**Short 21  
MANHATTAN**

Shot 21  
Short 21  
Copa pequeña 21  
Short 21

Inhalt	cap.	Höhe	height	Ø	Ø	VPE/PU	PAL
Ltr.	oz.	cm	in.	cm	in.	Stk/pcs.	Stk/pcs.
0,060	2,0	10,0	4	4,6	1 3/4	6	3024

ungeeicht / uncalibrated **58.0030.0021**  
 geeicht 2cl+4cl / calibrated 2cl+4cl **58.0030.0821**  
 Spülkorbempfehlung / washing rack recommendation **58.4608.5030**



**Longdrink 12  
MANHATTAN**

Longdrink 12  
Long drink 12  
Copa 12  
Longdrink 12

Inhalt	cap.	Höhe	height	Ø	Ø	VPE/PU	PAL
Ltr.	oz.	cm	in.	cm	in.	Stk/pcs.	Stk/pcs.
0,405	13,7	16,5	6 1/2	6,6	2 1/2	6	930

ungeeicht / uncalibrated **58.0030.0012**  
 geeicht 0,3l / calibrated 0,3l **58.0030.0412**  
 Spülkorbempfehlung / washing rack recommendation **58.4608.5018**



**Mixdrink 09  
MANHATTAN**

Mixdrink 09  
Boisson mélangée 09  
Combinado 09  
Mixdrink 09

Inhalt	cap.	Höhe	height	Ø	Ø	VPE/PU	PAL
Ltr.	oz.	cm	in.	cm	in.	Stk/pcs.	Stk/pcs.
0,350	11,8	14,4	5 3/4	6,5	2 1/2	6	1044

ungeeicht / uncalibrated **58.0030.0009**  
 geeicht 0,25l / calibrated 0,25l **58.0030.0309**  
 Spülkorbempfehlung / washing rack recommendation **58.4608.5017**



**Softdrink 14  
MANHATTAN**

Softdrink 14  
Boisson sans alcool 14  
Refresco 14  
Softdrink 14

Inhalt	cap.	Höhe	height	Ø	Ø	VPE/PU	PAL
Ltr.	oz.	cm	in.	cm	in.	Stk/pcs.	Stk/pcs.
0,290	9,8	10,7	4 1/4	7,0	2 3/4	6	1392

ungeeicht / uncalibrated **58.0030.0014**  
 geeicht 0,2l / calibrated 0,2l **58.0030.0214**  
 Spülkorbempfehlung / washing rack recommendation **58.4608.5016**



**Biertulpe 11  
MANHATTAN**

Tulip Beer Glass 11  
Flûte à bière 11  
Copa tulipa 11  
Calice da birra 11

Inhalt	cap.	Höhe	height	Ø	Ø	VPE/PU	PAL
Ltr.	oz.	cm	in.	cm	in.	Stk/pcs.	Stk/pcs.
0,380	12,8	21,1	8 <sup>1</sup> / <sub>4</sub>	7,5	3	6	504

ungeeicht / uncalibrated

**58.0030.0011**

geeicht 0,3l / calibrated 0,3l

**58.0030.0411**

Spülkorbempfehlung / washing rack recommendation

**58.4608.5012**



**Cocktail 96  
MANHATTAN**

Cocktail 96  
Cocktail 96  
Cóctel 96  
Cocktail 96

Inhalt	cap.	Höhe	height	Ø	Ø	VPE/PU	PAL
Ltr.	oz.	cm	in.	cm	in.	Stk/pcs.	Stk/pcs.
0,480	16,2	20,9	8 <sup>1</sup> / <sub>4</sub>	8,0	3 <sup>1</sup> / <sub>4</sub>	6	504

ungeeicht / uncalibrated

**58.0030.0096**

Spülkorbempfehlung / washing rack recommendation

**58.4608.5012**



**Margarita 97  
MANHATTAN**

Margarita 97  
Margarita 97  
Margarita 97  
Margarita 97

Inhalt	cap.	Höhe	height	Ø	Ø	VPE/PU	PAL
Ltr.	oz.	cm	in.	cm	in.	Stk/pcs.	Stk/pcs.
0,340	11,5	17,2	6 <sup>3</sup> / <sub>4</sub>	11,1	4 <sup>1</sup> / <sub>4</sub>	6	270

ungeeicht / uncalibrated

**58.0030.0097**

Spülkorbempfehlung / washing rack recommendation

**58.4608.5004**





**Wasserglas 15 rauchblau**

**DIVINE COLOR**

Tumbler 15 smoky blue

Verre à eau 15 bleu fumé

Vaso de agua 15 azul humo

Bicchieri di acqua 15 blu fumo

Inhalt	cap.	Höhe	height	Ø	Ø	VPE/PU	PAL
Ltr.	oz.	cm	in.	cm	in.	Stk/pcs.	Stk/pcs.
0,325	11,0	10,2	4	8,0	3 1/4	6	912

ungeeicht / uncalibrated

**58.0051.0015**

Spülkorbempfehlung / washing rack recommendation

**58.4608.5009**



**Wasserglas 15 rauchgrau**

**DIVINE COLOR**

Tumbler 15 smoky grey

Verre à eau 15 gris fumé

Vaso de agua 15 gris humo

Bicchieri di acqua 15 grigio fumo

Inhalt	cap.	Höhe	height	Ø	Ø	VPE/PU	PAL
Ltr.	oz.	cm	in.	cm	in.	Stk/pcs.	Stk/pcs.
0,325	11,0	10,2	4	8,0	3 1/4	6	912

ungeeicht / uncalibrated

**58.0052.0015**

Spülkorbempfehlung / washing rack recommendation

**58.4608.5009**



**Wasserglas 15 bernstein**

**DIVINE COLOR**

Tumbler 15 amber

Verre à eau 15 ambre

Vaso de agua 15 ámbar

Bicchieri di acqua 15 ambra

Inhalt	cap.	Höhe	height	Ø	Ø	VPE/PU	PAL
Ltr.	oz.	cm	in.	cm	in.	Stk/pcs.	Stk/pcs.
0,325	11,0	10,2	4	8,0	3 1/4	6	912

ungeeicht / uncalibrated

**58.0053.0015**

Spülkorbempfehlung / washing rack recommendation

**58.4608.5009**



**Wasserglas 15 oliv**

**DIVINE COLOR**

Tumbler 15 olive

Verre à eau 15 olive

Vaso de agua 15 verde oliva

Bicchieri di acqua 15 verde oliva

Inhalt	cap.	Höhe	height	Ø	Ø	VPE/PU	PAL
Ltr.	oz.	cm	in.	cm	in.	Stk/pcs.	Stk/pcs.
0,325	11,0	10,2	4	8,0	3 1/4	6	912

ungeeicht / uncalibrated

**58.0054.0015**

Spülkorbempfehlung / washing rack recommendation

**58.4608.5009**



**Karaffe 58**  
**Karaffe & Dekanter**

Carafe 58  
Carafe 58  
Jarra 58  
Caraffa 58

Inhalt	cap.	Höhe	height	Ø	Ø	VPE/PU	PAL
Ltr.	oz.	cm	in.	cm	in.	Stk/pcs.	Stk/pcs.
0,500	16,9	25,9	10 <sup>1</sup> / <sub>4</sub>	10,4	4	1	210

ungeeicht / uncalibrated  
geeicht 0,5l / calibrated 0,5l

58.0091.0058

58.0091.0758



**Karaffe 57**  
**Karaffe & Dekanter**

Carafe 57  
Carafe 57  
Jarra 57  
Caraffa 57

Inhalt	cap.	Höhe	height	Ø	Ø	VPE/PU	PAL
Ltr.	oz.	cm	in.	cm	in.	Stk/pcs.	Stk/pcs.
0,250	8,5	21,5	8 <sup>1</sup> / <sub>2</sub>	7,9	3	6	456

ungeeicht / uncalibrated  
geeicht 0,2l / calibrated 0,2l  
geeicht 0,25l / calibrated 0,25l

58.0091.0057

58.0091.0257

58.0091.0357



**Karaffe 53**  
**Karaffe & Dekanter**

Carafe 53  
Carafe 53  
Jarra 53  
Caraffa 53

Inhalt	cap.	Höhe	height	Ø	Ø	VPE/PU	PAL
Ltr.	oz.	cm	in.	cm	in.	Stk/pcs.	Stk/pcs.
0,100	3,4	17,6	7	6,3	2 <sup>1</sup> / <sub>2</sub>	6	720

ungeeicht / uncalibrated  
geeicht 0,1l / calibrated 0,1l

58.0091.0053

58.0091.0153



**Dekanter 59**  
**Karaffe & Dekanter**

Decanter 59  
Décanteur 59  
Decantador 59  
Decanter 59

Inhalt	cap.	Höhe	height	Ø	Ø	VPE/PU	PAL
Ltr.	oz.	cm	in.	cm	in.	Stk/pcs.	Stk/pcs.
0,750	25,4	21,3	8 <sup>1</sup> / <sub>2</sub>	19,4	7 <sup>3</sup> / <sub>4</sub>	1	60

ungeeicht / uncalibrated

58.0090.0059



**Café Crème-Set**

**CultureCup**

café crème set  
kit café crème  
juego café-crème  
set café crème

bestehend aus: 6 Tablett, 6 Porzellantassen M hoch, 6 Griffe M hoch,  
6 Gläser S, 6 Kaffeelöffel /  
consisting of: 6 serving trays, 6 porcelain cups M high, 6 handles M  
high, 6 glasses S, 6 tea/coffee spoons

Cromargan®, Glas, Porzellan /  
stainless 18/10, glass, porcelain

55.0111.6040



**Cappuccino-Set**

**CultureCup**

cappuccino set  
kit cappuccino  
juego capuchino  
set cappuccino

bestehend aus: 6 Tablett, 6 Porzellantassen M flach, 6 Ringe M flach,  
6 Kaffeelöffel /  
consisting of: 6 serving trays, 6 porcelain cups M low, 6 rings M low,  
6 tea/coffee spoons

Cromargan®, Porzellan / stainless 18/10, porcelain

55.0112.6040



**Espresso-Set**

**CultureCup**

espresso set  
kit espresso  
juego espresso  
set da café espresso

bestehend aus: 6 Tablett, 6 Porzellantassen S, 6 Griffe S, 6 Gläser S,  
6 Espresso-/Mokkalöffel /  
consisting of: 6 serving trays, 6 porcelain cups S, 6 handles S, 6 glasses  
S, 6 demi-tasse spoons

Cromargan®, Glas, Porzellan /  
stainless 18/10, glass, porcelain

55.0113.6040



**Kakao-Set**

**CultureCup**

cocoa set  
kit cacao  
juego cacao  
set cacao

bestehend aus: 6 Tablett, 6 Gläser L, 6 Griffe M hoch, 6 Kaffeelöffel /  
consisting of: 6 serving trays, 6 glasses L, 6 handles M high, 6 tea/  
coffee spoons

Cromargan®, Glas / stainless 18/10, glass

55.0260.6040





**Latte Macchiato-Set**

**CultureCup**

latte macchiato set  
kit latte-macchiato  
juego latte macchiato  
set latte-macchiato

bestehend aus: 6 Tablett, 6 Gläser bedruckt mit „Latte“, 6 Muglöffel /  
consisting of: 6 serving trays, 6 glasses printed with „Latte“, 6 mug  
spoons

Cromargan®, Glas / stainless 18/10, glass

55.0116.6040



**Allround "CultureCup-Set" (84 Teile!)**

all-round "CultureCup Set", (84 pieces!)  
kit "CultureCup" polyvalent, (84 pièces!)  
juego universal para el "CultureCup", (84 piezas!)  
set „CultureCup“ completo, (84 pezzoi!)

Das Allround-Set umfasst alles, was Sie für eine Belegung des  
Kaffeumsatzes benötigen. Bestehend aus den unten aufgeführten  
Produkten.

The all-round set includes everything you need to boost your coffee  
sales. Consisting of the below listed items.

Cromargan®, Glas, Porzellan /  
stainless 18/10, glass, porcelain

55.0117.6040

- |                           |                         |
|---------------------------|-------------------------|
| 12 Tablett                | 12 serving trays        |
| 12 Gläser S               | 12 glasses S            |
| 6 Porzellantassen M hoch  | 6 porcelain cups M high |
| 6 Porzellantassen M flach | 6 porcelain cups M low  |
| 6 Porzellantassen S       | 6 porcelain cups S      |
| 6 Griffe M hoch           | 6 handles S             |
| 6 Griffe M flach          | 6 handles M high        |
| 6 Griffe S                | 6 handles M low         |
| 6 Gläser LATTE            | 6 glasses LATTE         |
| 6 Muglöffel               | 6 mug spoons            |
| 6 Kaffeelöffel            | 6 tea/coffee spoons     |
| 6 Espressoelöffel         | 6 demi-tasse spoons     |

**Tablett**

**CultureCup**

serving tray  
plateau de service  
bandeja  
vassoio

Cromargan® / stainless 18/10

Größe	size
cm	in.
19,8 x 10,7 x 2	7 <sup>3</sup> / <sub>4</sub> x 4 <sup>1</sup> / <sub>4</sub> x 3 <sup>3</sup> / <sub>4</sub>

55.0115.6040





**Porzellantasse M hoch mit Griff  
CultureCup**

porcelain cup M high with handle  
tasse en porcelaine M haute avec anse  
taza de procelana M alta con asa  
tassa di porcellana M alta con maniglia

Cromargan®, Porzellan / stainless 18/10, porcelain

Höhe	height	Inhalt	cap.
cm	in.	Ltr.	oz.
8,7	3 1/2	0,24	8,1

Porzellantasse M hoch (VPE 6 Stk.) /  
porcelain cup M high (unit 6 pcs.)

55.0111.9805

Griff M hoch (VPE 6 Stk.) / handle M high (unit 6 pcs.)

55.0111.6042

\* Artikel einzeln bestellen / please order articles separately



**Porzellantasse M flach mit Griff  
CultureCup**

porcelain cup M low with handle  
tasse en porcelaine M plate avec anse  
taza de procelana M baja con asa  
tassa di porcellana M bassa con maniglia

Cromargan®, Porzellan / stainless 18/10, porcelain

Höhe	height	Inhalt	cap.
cm	in.	Ltr.	oz.
7,5	3	0,25	8,5

Porzellantasse M flach (VPE 6 Stk.) /  
porcelain cup M low (unit 6 pcs.)

55.0112.9805

Griff M flach (VPE 6 Stk.) / handle M low (unit 6 pcs.)

55.0112.6042

\* Artikel einzeln bestellen / please order articles separately



**Porzellantasse S mit Griff  
CultureCup**

porcelain cup S with handle  
tasse en porcelaine S avec anse  
taza de procelana S con asa  
tassa di porcellana S con maniglia

Cromargan®, Porzellan / stainless 18/10, porcelain

Höhe	height	Inhalt	cap.
cm	in.	Ltr.	oz.
6,9	2 3/4	0,08	2,7

Porzellantasse S (VPE 6 Stk.) / porcelain cup S (unit 6 pcs.)

55.0113.9805

Griff S (VPE 6 Stk.) / handle S (unit 6 pcs.)

55.0113.6042

\* Artikel einzeln bestellen / please order articles separately



**Glas L mit Griff**  
**CultureCup**

glass L with handle  
verre L avec anse  
vaso L con asa  
bicchiere L con maniglia

Cromargan®, Glas / stainless 18/10, glass

Höhe	height	Inhalt	cap.
cm	in.	Ltr.	oz.
9,5	3 <sup>3</sup> / <sub>4</sub>	0,3	10,1

Glas L (VPE 6 Stk.) / glass L (unit 6 pcs.) **55.0260.9995**

Griff M hoch (VPE 6 Stk.) / handle M high (unit 6 pcs.) **55.0111.6042**

\* Artikel einzeln bestellen / please order articles separately



**Glas LATTE (VPE 6 Stk.)**

glass LATTE (unit 6 pcs.)  
verre LATTE (UV 6 pc.)  
vaso LATTE (UV 6 p.)  
bicchiere LATTE (UV 6 p.)

Gläser bedruckt mit „LATTE“ /  
glasses printed with „LATTE“

Höhe	height	Inhalt	cap.	Ø	Ø
cm	in.	Ltr.	oz.	cm	in.
14,5	5 <sup>3</sup> / <sub>4</sub>	0,35	11,8	6,5	2 <sup>1</sup> / <sub>2</sub>

**55.0092.9990**



**Glas S (VPE 6 Stk.)**  
**CultureCup**

glass S (unit 6 pcs.)  
verre S (UV 6 pc.)  
vaso S (UV 6 p.)  
bicchiere S (UV 6 p.)

nicht kombinierbar mit: Deckel mit Ausschnitt 55.0031.6040 /  
not combinable with: lid with cut-out 55.0031.6040

Glas / glass

Höhe	height	Inhalt	cap.
cm	in.	Ltr.	oz.
7	2 <sup>3</sup> / <sub>4</sub>	0,09	3

**55.0114.9995**





### Löffel „CultureCup“

spoons „CultureCup“  
cuillers „CultureCup“  
cucharas „CultureCup“  
cucchiai „CultureCup“

Cromargan® / stainless 18/10

Länge	length
mm	in.
110	4 <sup>1</sup> / <sub>4</sub>
136	5 <sup>1</sup> / <sub>4</sub>
157	6 <sup>1</sup> / <sub>4</sub>

54.9901.6040

54.9902.6040

54.9903.6040

\* VPE 12 Stk. / unit 12 pcs.



### Deckel mit Ausschnitt

lid with cut-out  
couvercle avec découpe  
tapa con recorte  
coperchio con punto aperto per cucchiaio

passend zu Glas S, Porzellantasse S, Sahnekännchen von KaffeeKultur und Porzellantasse S von CultureCup. / fitting for glass S, porcelain cup S, creamer of CoffeeCulture and porcelain cup S of CultureCup.

Cromargan® / stainless 18/10

Ø	Ø
cm	in.
6	2 <sup>1</sup> / <sub>4</sub>

55.0031.6040



### Porzellanbehälter CultureCup

porcelain dish  
récipient en porcelaine  
recipiente de porcelana  
recipiente di porcellana

passend in Pure Exklusiv Einsätze und zu Deckel mit Ausschnitt / fitting in inserts Pure Exklusiv and to lid with cut-out

Cromargan®, Porzellan / stainless 18/10, porcelain

Höhe	height	Inhalt	cap.
cm	in.	Ltr.	oz.
6,6	2 <sup>1</sup> / <sub>2</sub>	0,08	2,7

Porzellantasse S (VPE 6 Stk.) / porcelain cup S (unit 6 pcs.) 55.0113.9805

Deckel mit Ausschnitt / lid with cut-out 55.0031.6040

Espresso-/Mokkalöffel (VPE 12 Stk.) /  
demi-tasse spoon (unit 12 pcs.) 54.9901.6040

\* Artikel einzeln bestellen / please order articles separately



**Latte Macchiato-Set**  
**KaffeeKultur**

latte macchiato set  
kit latte-macchiato  
juego latte macchiato  
set latte-macchiato

bestehend aus: 6 Tablett, 6 Gläser L bedruckt mit „Latte Macchiato“,  
6 Ringe L, 6 Muglöffel /  
consisting of: 6 serving trays, 6 glasses L printed with „Latte  
Macchiato“, 6 rings L, 6 mug spoons

Cromargan®, Glas / stainless 18/10, glass

06.2516.6040



**Milchkaffee-Set**  
**KaffeeKultur**

caffè Latte set  
kit café au lait  
juego café con leche  
set café latte

bestehend aus: 6 Tablett, 6 Gläser L unbedruckt, 6 Griffe L,  
6 Muglöffel /  
consisting of: 6 serving trays, 6 glasses L unprinted, 6 handles L,  
6 mug spoons

Cromargan®, Glas / stainless 18/10, glass

06.2519.6040



**Espresso-Set**  
**KaffeeKultur**

espresso set  
kit espresso  
juego espresso  
set da café espresso

bestehend aus: 6 Tablett, 6 Porzellantassen S, 6 Griffe S, 6 Gläser S,  
6 Ringe S, 6 Espresso-/Mokkalöffel /  
consisting of: 6 serving trays, 6 porcelain cups S, 6 handles S, 6 glasses  
S, 6 rings S, 6 demi-tasse spoons

Cromargan®, Glas, Porzellan /  
stainless 18/10, glass, porcelain

06.2518.6040



**Café Crème-Set**  
**KaffeeKultur**

café crème set  
kit café crème  
juego café-crème  
set café crème

bestehend aus: 6 Tablett, 6 Porzellantassen M, 6 Griffe M, 6 Gläser S,  
6 Ringe S, 6 Kaffeelöffel /  
consisting of: 6 serving trays, 6 porcelain cups M, 6 handles M,  
6 glasses S, 6 rings S, 6 tea/coffee spoons

Cromargan®, Glas, Porzellan /  
stainless 18/10, glass, porcelain

06.2517.6040



**Café au Lait-Set**  
**KaffeeKultur**

café au lait set  
kit café au lait  
juego café con leche  
set café au lait

bestehend aus: 6 Tablettts, 6 Milchkaffeeschalen, 6 Ringe XL,  
6 Muglöffel /  
consisting of: 6 serving trays, 6 milk coffee pots, 6 rings XL, 6 mug  
spoons

Cromargan®, Porzellan / stainless 18/10, porcelain **06.2527.6040**



**Doppel-Espresso-Set**  
**KaffeeKultur**

espresso double set  
kit espresso double  
juego espresso doble  
set café espresso doppio

bestehend aus: 6 Tablettts, 6 Doppel-Espresso-Tassen, 6 Griffe S, 6 Gläser  
S, 6 Ringe S, 6 Espressolöffel /  
consisting of: 6 serving trays, 6 cups Espresso double, 6 handles S,  
6 glasses S, 6 rings S, 6 demi-tasse spoons

Cromargan®, Glas, Porzellan /  
stainless 18/10, glass, porcelain **55.0043.6040**



**Allround "KaffeeKultur-Set" (über 100 Teile!)**

all-round "KaffeeKultur Set", (over 100 pieces!)  
kit "KaffeeKultur" polyvalent, (plus de 100 pièces!)  
juego universal para el "KaffeeKultur", (más de 100 piezas!)  
set „KaffeeKultur“ completo, (più di 100 pezzi!)

Das Allround-Set umfasst alles, was Sie für eine Belegung des  
Kaffeumsatzes benötigen. Bestehend aus den unten aufgeführten  
Produkten.

The all-round set includes everything you need to boost your coffee  
sales. Consisting of the below listed items.

Cromargan®, Glas, Porzellan /  
stainless 18/10, glass, porcelain **06.2520.6040**

- |                         |                         |
|-------------------------|-------------------------|
| 12 Tablettts            | 12 serving trays        |
| 6 Gläser L (bedruckt)   | 6 glasses L (printed)   |
| 6 Gläser L (unbedruckt) | 6 glasses L (unprinted) |
| 12 Gläser S             | 12 glasses S            |
| 6 Porzellantassen M     | 6 porcelain cups M      |
| 6 Porzellantassen S     | 6 porcelain cups S      |
| 6 Ringe L               | 6 rings L               |
| 12 Ringe S              | 12 rings S              |
| 6 Griffe L              | 6 handles L             |
| 6 Griffe M              | 6 handles M             |
| 6 Griffe S              | 6 handles S             |
| 6 Muglöffel             | 6 mug spoons            |
| 6 Kaffeelöffel          | 6 tea/coffee spoons     |
| 6 Espressolöffel        | 6 demi-tasse spoons     |



**Einzelartikel "KaffeeKultur"**

single items "KaffeeKultur"  
 articles isolés "KaffeeKultur"  
 artículos diversos "KaffeeKultur"  
 singolo articolo "KaffeeKultur"

Cromargan®, Glas, Porzellan / stainless 18/10, glass, porcelain



①

① Tablett / serving tray  
 Größe size  
 cm in.  
 18,8 x 12 x 2 7 1/2 x 4 3/4 x 3/4 **06.2500.6040**



②



③



④

② Glas L bedruckt (VPE 6 Stk.) / glass L printed (unit 6 pcs.)  
 Höhe height Inhalt cap.  
 cm in. Ltr. oz.  
 11,6 4 1/2 0,32 10,8 **60.2505.9990**

③ Glas L unbedruckt (VPE 6 Stk.) / glass L unprinted (unit 6 pcs.)  
 Höhe height Inhalt cap.  
 cm in. Ltr. oz.  
 11,6 4 1/2 0,32 10,8 **60.2505.9991**

④ Glas S (VPE 6 Stk.) / glass S (unit 6 pcs.)  
 Höhe height Inhalt cap.  
 cm in. Ltr. oz.  
 7,4 3 0,1 3,4 **60.2506.9990**

⑤ Milchkaffeeschale (VPE 6 Stk.) / milk coffee pot (unit 6 pcs.)  
 Höhe height Inhalt cap.  
 cm in. Ltr. oz.  
 9,6 3 3/4 0,4 13,5 **60.2526.9990**

⑥ Porzellantasse M (VPE 6 Stk.) / porcelain cup M (unit 6 pcs.)  
 Höhe height Inhalt cap.  
 cm in. Ltr. oz.  
 9,6 3 3/4 0,25 8,5 **60.2507.9990**



⑤



⑥



⑦



⑧

⑦ Doppel-Espressotasse (VPE 6 Stk.) / Espresso cup double (unit 6 pcs.)  
 Höhe height Inhalt cap. Ø Ø  
 cm in. Ltr. oz. cm in.  
 8,4 3 1/4 0,13 4,4 6,2 2 1/2 **60.2541.9990**

⑧ Porzellantasse S (VPE 6 Stk.) / porcelain cup S (unit 6 pcs.)  
 Höhe height Inhalt cap.  
 cm in. Ltr. oz.  
 7,4 3 0,1 3,4 **60.2508.9990**

⑨ Ring XL (VPE 6 Stk.) / ring XL (unit 6 pcs.)  
 passend auf Milchkaffeeschale / fitting on milk coffee pot **06.2525.6040**

⑩ Ring L (VPE 6 Stk.) / ring L (unit 6 pcs.)  
 passend auf Glas L / fitting on glass L **06.2501.6040**

⑪ Ring S (VPE 6 Stk.) / ring S (unit 6 pcs.)  
 passend auf Glas S, Tasse S, Doppel-Espresso-Tasse und Sahnekännchen von KaffeeKultur / fitting on glass S, cup S, Espresso double cup and creamer of CoffeeCulture **06.2502.6040**

⑫ Griff L (VPE 6 Stk.) / handle L (unit 6 pcs.)  
 passend auf Glas L / fitting on glass L **06.2503.6040**

⑬ Griff M (VPE 6 Stk.) / handle M (unit 6 pcs.)  
 passend auf Porzellantasse M / fitting on porcelain cup M **06.2504.6040**

⑭ Griff S (VPE 6 Stk.) / handle S (unit 6 pcs.)  
 passend auf Glas S, Porzellantasse S, Doppel-Espressotasse und Sahnekännchen von KaffeeKultur / fitting on glass S, porcelain cup S, Espresso cup double and creamer of CoffeeCulture **06.2509.6040**

⑮ Muglöffel (VPE 12 Stk.) / mug spoon (unit 12 pcs.)  
 Länge length  
 mm in.  
 157 6 1/4 **54.9903.6040**

⑯ Kaffeeelöffel (VPE 12 Stk.) / tea/coffee spoon (unit 12 pcs.)  
 Länge length  
 mm in.  
 136 5 1/4 **54.9902.6040**

⑰ Espresso-/Mokkalöffel (VPE 12 Stk.) / demi-tasse spoon (unit 12 pcs.)  
 Länge length  
 mm in.  
 110 4 1/4 **54.9901.6040**



⑮



⑯



⑰



### Sahnekännchen (VPE 6 Stk.)

#### KaffeeKultur

creamer (unit 6 pcs.)  
 crémier (UV 6 pc.)  
 cremera (UV 6 p.)  
 bricchetto per il latte (UV 6 p.)

kombinierbar mit Ring S, Griff S von KaffeeKultur und Deckel mit Ausschnitt /

to be combined with ring S, handle S CoffeeCulture and lid with cut-out

Porzellan / porcelain

Höhe	height	Inhalt	cap.
cm	in.	Ltr.	oz.
7	2 <sup>3</sup> / <sub>4</sub>	0,1	3,4

55.0033.9990



### Deckel mit Ausschnitt

lid with cut-out  
 couvercle avec découpe  
 tapa con recorte  
 coperchio con punto aperto per cucchiaino

passend zu Glas S, Porzellantasse S, Sahnekännchen von KaffeeKultur und Porzellantasse S von CultureCup. /

fitting for glass S, porcelain cup S, creamer of CoffeeCulture and porcelain cup S of CultureCup.

Cromargan® / stainless 18/10

Ø	Ø
cm	in.
6	2 <sup>1</sup> / <sub>4</sub>

55.0031.6040



### Sahne-/Zucker-Set

#### KaffeeKultur

sugar and milk set  
 service pots à lait / sucriers  
 juego azucarero / cremera  
 set lattiera zuccheriera

bestehend aus: Tablett, Sahnekännchen und Zuckerbehälter. /  
 consisting of: serving tray, creamer and sugar bowl.

Cromargan®, Porzellan / stainless 18/10, porcelain

Tablett / serving tray

Größe	size
cm	in.
18,8 x 12 x 2	7 <sup>1</sup> / <sub>2</sub> x 4 <sup>3</sup> / <sub>4</sub> x 3 <sup>3</sup> / <sub>4</sub>

06.2500.6040

Sahnekännchen (VPE 6 Stk.) / creamer (unit 6 pcs.)

Höhe	height	Inhalt	cap.
cm	in.	Ltr.	oz.
7	2 <sup>3</sup> / <sub>4</sub>	0,1	3,4

55.0033.9990

Griff S (VPE 6 Stk.) / handle S (unit 6 pcs.)

06.2509.6040

Porzellantasse S (VPE 6 Stk.) / porcelain cup S (unit 6 pcs.)

Höhe	height	Inhalt	cap.
cm	in.	Ltr.	oz.
7,4	3	0,1	3,4

60.2508.9990

Ring S (VPE 6 Stk.) / ring S (unit 6 pcs.)

06.2502.6040

Deckel mit Ausschnitt / lid with cut-out

55.0031.6040

Espresso-/Mokkalöffel (VPE 12 Stk.) /

54.9901.6040

demi-tasse spoon (unit 12 pcs.)

\* Artikel einzeln bestellen / please order articles separately



**Sahnekännchen, mit Deckel**

**KaffeeKultur**

creamer, with lid  
 crémier, avec couvercle  
 cremaera, con tapa  
 bricchetto per il latte, con coperchio

Cromargan®, Porzellan / stainless 18/10, porcelain

Sahnekännchen (VPE 6 Stk.) / creamer (unit 6 pcs.)

Höhe	height	Inhalt	cap.	
cm	in.	Ltr.	oz.	
7	2 <sup>3</sup> / <sub>4</sub>	0,1	3,4	55.0033.9990

Griff S (VPE 6 Stk.) / handle S (unit 6 pcs.) **06.2509.6040**

Deckel mit Ausschnitt / lid with cut-out **55.0031.6040**

\* Artikel einzeln bestellen / please order articles separately



**Porzellanbehälter**

**KaffeeKultur**

porcelain dish  
 récipient en porcelaine  
 recipiente de porcelana  
 recipiente di porcellana

für Zucker, Marmelade, Senf u.a. /  
 for sugar, jam, mustard ...

Cromargan®, Porzellan / stainless 18/10, porcelain

Porzellantasse S (VPE 6 Stk.) / porcelain cup S (unit 6 pcs.)

Höhe	height	Inhalt	cap.	
cm	in.	Ltr.	oz.	
7,4	3	0,1	3,4	60.2508.9990

Ring S (VPE 6 Stk.) / ring S (unit 6 pcs.) **06.2502.6040**

Deckel mit Ausschnitt / lid with cut-out **55.0031.6040**

Espresso-/Mokkalöffel (VPE 12 Stk.) /  
 demi-tasse spoon (unit 12 pcs.) **54.9901.6040**

\* Artikel einzeln bestellen / please order articles separately



**Glasbehälter**

**KaffeeKultur**

glass dish  
 récipient en verre  
 recipiente de cristal  
 recipiente di vetro

für Zucker, Marmelade, Senf u.a. /  
 for sugar, jam, mustard ...

Cromargan®, Glas / stainless 18/10, glass

Glas S (VPE 6 Stk.) / glass S (unit 6 pcs.)

Höhe	height	Inhalt	cap.	
cm	in.	Ltr.	oz.	
7,4	3	0,1	3,4	60.2506.9990

Ring S (VPE 6 Stk.) / ring S (unit 6 pcs.) **06.2502.6040**

Deckel mit Ausschnitt / lid with cut-out **55.0031.6040**

Espresso-/Mokkalöffel (VPE 12 Stk.) /  
 demi-tasse spoon (unit 12 pcs.) **54.9901.6040**

\* Artikel einzeln bestellen / please order articles separately





### Latte Macchiato-Set

Latte Macchiato Set  
latte-macchiato-set  
juego latte macchiato  
set latte-macchiato

12er Set bestehend aus:  
12 x Glas, 12 x Löffel, 12 x Unterteller (Durchm. 12 cm) /  
set of 12 pcs. consisting of:  
12 x glass, 12 x spoon, 12 x underliner (dia. 4<sup>3</sup>/<sub>4</sub> in.)

Cromargan®, Glas / stainless 18/10, glass

Inhalt	cap.
Ltr.	oz.
0,3	10,5

06.3172.6040

Ersatzteil / spare part:

Eiskaffeeelöffel / iced tea spoon  
6er Set Gläser / 6 glasses

12.9188.6040

19.9999.8667



### Gläser-Set, Iced Coffee-Set

glass set, iced coffee set  
set à glass  
juego vasos  
set da bicchieres

bestehend aus: Tablett, Glas und Muglöffel /  
consisting of: serving tray, glass and mug spoon

Cromargan®, Glas / stainless 18/10, glass

Tablett / serving tray

Größe	size
cm	in.
18,8 x 12 x 2	7 <sup>1</sup> / <sub>2</sub> x 4 <sup>3</sup> / <sub>4</sub> x 3 <sup>3</sup> / <sub>4</sub>

06.2500.6040

Glas (6 St.) / glass (6 pcs.)

Inhalt	cap.
Ltr.	oz.
0,3	10,5

55.0089.9990

Muglöffel (VPE 12 Stk.) / mug spoon (unit 12 pcs.)

Länge	length
mm	in.
157	6 <sup>1</sup> / <sub>4</sub>

54.9903.6040



### Teeglas

#### PURE

tea glass  
verre à thé  
vaso té  
bicchiere da té

Cromargan®, Glas / stainless 18/10, glass

Höhe	height	Inhalt	cap.	Ø	Ø
cm	in.	Ltr.	oz.	cm	in.
9	3 <sup>1</sup> / <sub>2</sub>	0,2	6,76	6,5	2 <sup>1</sup> / <sub>2</sub>

06.3565.6040

Ersatzteil / spare part:

Glaseinsatz / glass insert

60.3147.9990



**Teesieb-Behälter (VPE 6 Stk.)**

tea strainer holder (unit 6 pcs.)  
 soucoupe pour passoire à thé (UV 6 pc.)  
 recipiente colador té (UV 6 p.)  
 contenitore per colino tè (UV 6 p.)

für Teesieb-Einsatz 06.3428.6030; kombinierbar mit Ring S von KaffeeKultur /  
 fitting for tea strainer insert 06.3428.6030; to be combined with ring S CoffeeCulture

Porzellan, weiß / porcelain, white

Höhe	height	Inhalt	cap.	Ø	Ø	
cm	in.	Ltr.	oz.	cm	in.	
8,4	3 <sup>1</sup> / <sub>4</sub>	0,13	4,4	6,2	2 <sup>1</sup> / <sub>2</sub>	<b>60.2541.9990</b>

Zubehör / accessory:

Ring S (VPE 6 Stk.) / ring S (unit 6 pcs.) 06.2502.6040



**Teesieb-Einsatz**

tea strainer insert  
 passoire à thé  
 interior colador té  
 colino per tè

passend in alle WMF-Teekannen /  
 fitting in all WMF tea pots

Cromargan® / stainless 18/10

Höhe	height	Ø	Ø	
cm	in.	cm	in.	
7	2 <sup>3</sup> / <sub>4</sub>	5	2	<b>06.3428.6030</b>



**Teesieb, mit Abtropfschale**

tea strainer, with bowl  
 passoire, avec réceptacle à thé  
 recipiente colador, de té con bandejita escurridora  
 colino per tè con vaschetta raccogliogocce

Größe	size	Höhe	height	Cromargan®	versilbert
cm	in.	cm	in.	stainless 18/10	silverplated
12 x 9,5	4 <sup>3</sup> / <sub>4</sub> x 3 <sup>3</sup> / <sub>4</sub>	3	1 <sup>1</sup> / <sub>4</sub>	<b>06.3327.6040</b>	<b>19.3327.6440</b>



**Zitronenpresse, 6er Set**

lemon/orange squeezer, set of 6  
 presse-citron, en 6 parties  
 exprimidor para limones, 6 piezas  
 spremilimone, a 6 vaschette

Cromargan® mattiert / stainless 18/10, satin finished **06.8221.6030**



### Kaffeekanne

#### URBAN

coffee pot  
cafetière  
cafetera  
caffettiera

Höhe cm	height in.	Inhalt Ltr.	cap. oz.	Cromargan® stainless 18/10	versilbert silverplated
13,5	5 <sup>1</sup> / <sub>4</sub>	0,3	10,14	<b>06.3342.6041</b>	<b>19.3342.6441</b>
15,5	6	0,5	16,9	<b>06.3344.6041</b>	<b>19.3344.6441</b>
20	7 <sup>3</sup> / <sub>4</sub>	1	33,8	<b>06.3346.6041</b>	<b>19.3346.6441</b>



### Teekanne

#### URBAN

tea pot  
théière  
tetera  
teiera

Höhe cm	height in.	Inhalt Ltr.	cap. oz.	Cromargan® stainless 18/10	versilbert silverplated
12	4 <sup>3</sup> / <sub>4</sub>	0,3	10,14	<b>06.3350.6041</b>	<b>19.3350.6441</b>
14	5 <sup>1</sup> / <sub>2</sub>	0,5	16,9	<b>06.3351.6041</b>	<b>19.3351.6441</b>



### Milchkanne

#### URBAN

milk jug  
pot à lait  
lechera  
lattiera

Höhe cm	height in.	Inhalt Ltr.	cap. oz.	Cromargan® stainless 18/10	versilbert silverplated
9,6	3 <sup>3</sup> / <sub>4</sub>	0,2	6,76	<b>06.3360.6041</b>	<b>19.3360.6441</b>
11,5	4 <sup>1</sup> / <sub>2</sub>	0,3	10,14	<b>06.3361.6041</b>	<b>19.3361.6441</b>



### Zuckerdose

#### URBAN

sugar basin  
sucrier  
azucarero  
zuccheriera

Höhe cm	height in.	Inhalt Ltr.	cap. oz.	Cromargan® stainless 18/10	versilbert silverplated
7,4	3	0,25	8,45	<b>06.3370.6041</b>	<b>19.3370.6441</b>





**Kaffeekanne**

**CLASSIC**

coffee pot  
cafétière  
cafetera  
caffettiera

Höhe cm	height in.	Inhalt Ltr.	cap. oz.	Cromargan® stainless 18/10	versilbert silverplated
13,5	5 <sup>1</sup> / <sub>4</sub>	0,3	11	<b>06.3501.6040</b>	<b>19.3501.6440</b>
17	6 <sup>3</sup> / <sub>4</sub>	0,6	21	<b>06.3502.6040</b>	<b>19.3502.6440</b>
22	8 <sup>3</sup> / <sub>4</sub>	1,5	53	<b>06.3504.6040</b>	<b>19.3504.6440</b>
25,5	10	2	70	<b>06.3509.6040</b>	



**Teekanne**

**CLASSIC**

tea pot  
théière  
tetera  
teiera

Höhe cm	height in.	Inhalt Ltr.	cap. oz.	Cromargan® stainless 18/10	versilbert silverplated
11	4 <sup>1</sup> / <sub>4</sub>	0,3	11	<b>06.3506.6040</b>	<b>19.3506.6440</b>
14,5	5 <sup>3</sup> / <sub>4</sub>	0,55	19	<b>06.3507.6040</b>	<b>19.3507.6440</b>
17,5	7	1,25	44	<b>06.3508.6040</b>	<b>19.3508.6440</b>



**Milchkanne**

**CLASSIC**

milk jug  
pot à lait  
lechera  
lattiera

Höhe cm	height in.	Inhalt Ltr.	cap. oz.	Cromargan® stainless 18/10	versilbert silverplated
8,5	3 <sup>1</sup> / <sub>2</sub>	0,15	5	<b>06.3512.6040</b>	<b>19.3512.6440</b>
11	4 <sup>1</sup> / <sub>4</sub>	0,3	11	<b>06.3513.6040</b>	<b>19.3513.6440</b>
13,5	5 <sup>1</sup> / <sub>2</sub>	0,6	21	<b>06.3514.6040</b>	<b>19.3514.6440</b>



**Zuckerdose**

**CLASSIC**

sugar basin  
sucrier  
azucarero  
zuccheriera

Höhe cm	height in.	Inhalt Ltr.	cap. oz.	Cromargan® stainless 18/10	versilbert silverplated
7	2 <sup>3</sup> / <sub>4</sub>	0,25	8,8	<b>06.3519.6040</b>	<b>19.3519.6440</b>



**Zuckerdose, mit Deckel  
CLASSIC**

sugar basin, with cover  
sucrier, avec couvercle  
azucarero, con tapa  
zuccheriera, con coperchio

Höhe cm	height in.	Inhalt Ltr.	cap. oz.	Cromargan® stainless 18/10	versilbert silverplated
9,5	3 <sup>3</sup> / <sub>4</sub>	0,15	5,3	<b>06.3520.6040</b>	<b>19.3520.6440</b>
12	4 <sup>3</sup> / <sub>4</sub>	0,25	8,8	<b>06.3521.6040</b>	<b>19.3521.6440</b>



**Kaffeekanne  
PURE**

coffee pot  
cafétière  
cafetera  
caffettiera

stapelbar /  
stackable

Cromargan®, teilmattiert /  
stainless 18/10, partly satin finished

Höhe cm	height in.	Inhalt Ltr.	cap. oz.	
11,5	4 <sup>1</sup> / <sub>2</sub>	0,3	11	<b>06.3801.6040</b>
14	5 <sup>1</sup> / <sub>2</sub>	0,6	21	<b>06.3808.6040</b>
20	8	1,9	66,5	<b>06.3809.6040</b>



**Teekanne  
PURE**

tea pot  
théière  
tetera  
teiera

stapelbar /  
stackable

Cromargan®, teilmattiert /  
stainless 18/10, partly satin finished

Höhe cm	height in.	Inhalt Ltr.	cap. oz.	
9,5	3 <sup>3</sup> / <sub>4</sub>	0,3	11	<b>06.3802.6040</b>



**Milchkännchen**

**PURE**

creamer  
pots à lait  
cremera  
lattiera

Cromargan®, teilmattiert /  
stainless 18/10, partly satin finished

Höhe	height	Inhalt	cap.
cm	in.	Ltr.	oz.
8,5	3 1/4	0,2	7

06.3806.6040



**Sahnegießer**

**PURE**

creamer  
crémier  
cremera  
cremiera

Cromargan®, teilmattiert /  
stainless 18/10, partly satin finished

Höhe	height	Inhalt	cap.
cm	in.	Ltr.	oz.
5	2	0,03	1,1

06.3807.6040



**Zuckerdose**

**PURE**

sugar basin  
sucrier  
azucarero  
zuccheriera

Cromargan®, teilmattiert /  
stainless 18/10, partly satin finished

Höhe	height	Inhalt	cap.
cm	in.	Ltr.	oz.
8,5	3 1/4	0,2	7

06.3805.6040



**Zuckerdose, mit Deckel**

**PURE**

sugar basin, with cover  
sucrier, avec couvercle  
azucarero, con tapa  
zuccheriera, con coperchio

Cromargan®, teilmattiert /  
stainless 18/10, partly satin finished

Höhe	height	Inhalt	cap.	Ø	Ø
cm	in.	Ltr.	oz.	cm	in.
5,2	2	0,1	3,5	6	2 1/4

06.2342.6040



### Zuckerstangengefäß

#### PURE

sugar pack holder  
pots à sucriers  
azucarero para azúcar en cañas  
set zuccheriera

stapelbar /  
stackable

Cromargan®, teilmattiert /  
stainless 18/10, partly satin finished

Höhe	height	Ø	Ø
cm	in.	cm	in.
8,5	3 1/4	6	2 1/4

06.7120.6040



### Isolierkanne

#### CONCEPT

vacuum jug  
pot isotherme  
jarra isotérmica  
carraffa termica

doppelwandig, spülmaschinenfest, 12 Std. heiß/ 24 Std. kalt /  
double wall, dishwasher safe, 12 h hot/ 24 h cold

Edelstahl 18/10 / stainless 18/10

Höhe	height	Inhalt	cap.
cm	in.	Ltr.	oz.
21,6	8 1/2	0,6	21,12
28,2	11	1	25,21

06.9056.6040

06.9057.6040



### Zuckerdosierer

sugar dispenser  
saupoudreuse à sucre  
dosificador azúcar  
versazucchero

Cromargan®, Glas / stainless 18/10, glass

Höhe	height	Inhalt	cap.
cm	in.	Ltr.	oz.
15,5	6	0,24	8,4

06.3661.6040

Ersatzteil / spare part:

Ersatzglas / spare glass

60.8294.9990



### Honig-/Sahnepender

honey/cream dispenser  
distributeur à miel / crème  
dispensador miel / nata  
versamiele / versalette

Cromargan®, Glas / stainless 18/10, glass

Höhe	height	Inhalt	cap.
cm	in.	Ltr.	oz.
15,5	6	0,24	8,4

06.3664.6040

Ersatzteil / spare part:

Ersatzglas / spare glass

60.8294.9990





**Zuckergestell, 4tlg.  
CLASSIC**

sugar server, set of 4  
service à sucre, en 4 parties  
servicio de azúcar, 4 piezas  
zuccheriera, a 4 vaschette

Höhe	height
cm	in.
21	8 <sup>1</sup> / <sub>4</sub>

Cromargan®	versilbert
stainless 18/10	silverplated
<b>06.3186.6040</b>	<b>19.3186.6440</b>

Ersatzteil / spare part:  
Porzellaneinsatz / porcelain insert

60.3099.9990



**Serviertablett für Zucker**

serving tray for sugar  
plateau de service pour sucre  
bandeja con azucareros  
vassoio per zucchero

Tablett, oval / serving tray, oval

Größe	size
cm	in.
22 x 15,5	8 <sup>3</sup> / <sub>4</sub> x 6

Cromargan®	versilbert
stainless 18/10	silverplated
<b>06.7540.6040</b>	<b>19.7540.6440</b>

Zuckerdose / sugar bowl

Ø	Ø	Inhalt
cm	in.	Ltr.
6	2 <sup>1</sup> / <sub>4</sub>	0,1

cap.	Cromargan®
oz.	stainless 18/10
3,5	<b>06.3752.6040</b>

\* Artikel einzeln bestellen / please order articles separately



**Milch-Zucker-Set  
CLASSIC**

sugar and creamer set  
service pots à lait / sucriers  
juego azucarero / cremera  
set lattiera zuccheriera

Cromargan® / stainless 18/10

Höhe	height
cm	in.
18,5	7 <sup>1</sup> / <sub>4</sub>

**06.3185.6040**

Ersatzteil / spare part:

Milchkanne / milk jug

06.3415.6040

Höhe	height
cm	in.
8	3 <sup>1</sup> / <sub>4</sub>

Zuckerdose / sugar bowl

06.3752.6040

Ø	Ø	Inhalt	cap.
cm	in.	Ltr.	oz.
6	2 <sup>1</sup> / <sub>4</sub>	0,1	3,5



### Sahne-Zucker-Set PURE

sugar and creamer set  
service pots à lait / sucriers  
juego azucarero / cremera  
set lattiera zuccheriera

bestehend aus: Gestell, Sahnekännchen, Zuckerdose, Löffel /  
consisting of: stand, cream dispenser, sugar dispenser, spoon

Cromargan®, teilmattiert /  
stainless 18/10, partly satin finished

Höhe	height	Inhalt	cap.
cm	in.	Ltr.	oz.
18	7	0,2	7

**06.3804.6040**

Ersatzteil / spare part:

Gestell / stand	06.3804.6045
Milchkännchen / creamer	06.3806.6040
Zuckerdose / sugar basin	06.3805.6040



### Sahne-Zucker-Set PURE

sugar and creamer set  
service pots à lait / sucriers  
juego azucarero / cremera  
set lattiera zuccheriera

bestehend aus: Gestell, Sahnekännchen, Zuckerstangengefäß /  
consisting of: stand, cream dispenser, sugar pack holder

Cromargan®, teilmattiert /  
stainless 18/10, partly satin finished

Höhe	height	Inhalt	cap.
cm	in.	Ltr.	oz.
18	7	0,2	7

**06.3803.6040**

Ersatzteil / spare part:

Gestell / stand	06.3804.6045
Milchkännchen / creamer	06.3806.6040
Zuckerstangengefäß / sugar pack holder	06.7120.6040



### Zuckergestell, 4tlg. PURE

sugar set, 4 pcs.  
service à sucriers, 4 parties  
juego azucarero, 4 piezas  
set zuccheriera, a 4vaschette

bestehend aus: Gestell, 4x Zuckerbehälter /  
consisting of: stand, 4 sugar bowls

Cromargan® / stainless 18/10

Höhe	height	Ø	Ø
cm	in.	cm	in.
16,1	6 1/2	14	5 1/2

**06.2339.6040**

Ersatzteil / spare part:

Gestell nieder / stand low	06.2340.6045		
Höhe	height	Ø	Ø
cm	in.	cm	in.
16	6 1/4	14	5 1/2

Porzellaninsert / porcelain insert 60.3099.9990





**Sahne-Zucker-Set**

**PURE**

sugar and milk set  
 service pots à lait / sucriers  
 juego azucarero / cremera  
 set lattiera zuccheriera

bestehend aus Gestell, 2x Zuckerbehälter Glas und Sahnekännchen Porzellan /

consisting of: stand, 2x sugar bowl glass and creamer porcelain

Cromargan®, Glas, Porzellan / stainless 18/10, glass, porcelain

Gestell nieder / stand low

Höhe cm	height in.	Ø cm	Ø in.	
16	6 1/4	14	5 1/2	<b>06.2340.6045</b>

Glas S (VPE 6 Stk.) / glass S (unit 6 pcs.)

Höhe cm	height in.	Inhalt Ltr.	cap. oz.	
7,4	3	0,1	3,4	<b>60.2506.9990</b>

Ring S (VPE 6 Stk.) / ring S (unit 6 pcs.)

**06.2502.6040**

Deckel mit Ausschnitt / lid with cut-out

**55.0031.6040**

Sahnekännchen (VPE 6 Stk.) / creamer (unit 6 pcs.)

Höhe cm	height in.	Inhalt Ltr.	cap. oz.	
7	2 3/4	0,1	3,4	<b>55.0033.9990</b>

Griff S (VPE 6 Stk.) / handle S (unit 6 pcs.)

**06.2509.6040**

Espresso-/Mokkalöffel (VPE 12 Stk.) /  
 demi-tasse spoon (unit 12 pcs.)

**54.9901.6040**

\* Artikel einzeln bestellen / please order articles separately



**Milch-Zucker-Set, 3tlg.**

**PURE**

sugar and milk set, set of 3  
 service pots à lait / sucriers, en 3 parties  
 juego azucarero / cremera, 3 piezas  
 set lattiera zuccheriera, a 3 vaschette

bestehend aus: Gestell, 2x Zuckerbehälter, 1 Sahnekännchen /  
 consisting of: stand, 2x sugar bowl, 1 milk pot

Cromargan® / stainless 18/10

Höhe cm	height in.	Ø cm	Ø in.	
16,1	6 1/2	14	5 1/2	<b>06.2340.6040</b>

Ersatzteil / spare part:

Zuckerdose, mit Deckel / sugar basin, with cover

**06.2342.6040**

Höhe cm	height in.	Inhalt Ltr.	cap. oz.
5,2	2	0,1	3,5

Gestell nieder / stand low

**06.2340.6045**

Höhe cm	height in.	Ø cm	Ø in.
16	6 1/4	14	5 1/2

Milchkännchen / creamer

**06.3806.6040**

Höhe cm	height in.	Inhalt Ltr.	cap. oz.
8,5	3 1/4	0,2	7

## Milch-Zucker-Set PURE EXCLUSIV

sugar and milk set  
service pots à lait / sucriers  
juego azucarero / cremera  
set lattiera zuccheriera

in 2 Holzvarianten. Mit 3 Einsätzen für wahlweise Gläser S, Tassen S (o. Abb.) oder Sahnekännchen KAFFEEKULTUR und Tassen S von CULTURECUP (o. Abb.). Nicht spülmaschinengeeignet! /  
in 2 wood versions. With 3 inserts alternatively for glasses S, cups S (w/o pic.) or creamer of CoffeeCulture and cups S of CultureCup (w/o pic.). Not dishwasher-safe!

Cromargan®, Holz dunkel gebeizt, Holz lackiert /  
stainless 18/10, wood dark stained, wood lacquered

Menage klein dunkel / stand small dark

Größe	size
cm	in.
20,5 x 6,2 x 3,7	8 x 2 <sup>1</sup> / <sub>2</sub> x 1 <sup>1</sup> / <sub>2</sub>

55.0039.6040

Menage klein natur / stand small nature

Größe	size
cm	in.
20,5 x 6,2 x 3,7	8 x 2 <sup>1</sup> / <sub>2</sub> x 1 <sup>1</sup> / <sub>2</sub>

55.0039.6140

Glas S (VPE 6 Stk.) / glass S (unit 6 pcs.)

Höhe	height	Inhalt	cap.
cm	in.	Ltr.	oz.
7,4	3	0,1	3,4

60.2506.9990

Sahnekännchen (VPE 6 Stk.) / creamer (unit 6 pcs.)

Höhe	height	Inhalt	cap.
cm	in.	Ltr.	oz.
7	2 <sup>3</sup> / <sub>4</sub>	0,1	3,4

55.0033.9990

Deckel mit Ausschnitt / lid with cut-out

55.0031.6040

Espresso-/Mokkalöffel (VPE 12 Stk.) /  
demi-tasse spoon (unit 12 pcs.)

54.9901.6040

\* Artikel einzeln bestellen / please order articles separately





**Milch-Zucker-Set, 4tlg.**

**PURE EXCLUSIV**

sugar and milk set, set of 4  
 service pots à lait / sucriers, en 4 parties  
 juego azucarero / cremera, 4 piezas  
 set lattiera zuccheriera, a 4 vaschette

in 2 Holzvarianten. Mit 4 Einsätzen für Gläser S oder Tassen S (o.Abb.) von KAFFEEKULTUR, Sahnekännchen und Zuckerstangengefäß von PURE oder Tassen S von CULTURECUP (o.Abb.). Nicht spülmaschinengeeignet! / in 2 wood versions. With 4 inserts for glasses S or cups S (w/o pic.) of CoffeeCulture or creamer and sugar pack holder of PURE or cups S of CultureCup (w/o pic.). Not dishwasher-safe!

Cromargan®, Holz dunkel gebeizt, Holz lackiert / stainless 18/10, wood dark stained, wood lacquered

**Menage groß dunkel / stand large dark**

Größe	size	
cm	in.	
14,5 x 14,5 x 25,4	5 <sup>3</sup> / <sub>4</sub> x 5 <sup>3</sup> / <sub>4</sub> x 10	<b>55.0034.6040</b>

**Menage groß natur / stand large nature**

Größe	size	
cm	in.	
14,5 x 14,5 x 25,4	5 <sup>3</sup> / <sub>4</sub> x 5 <sup>3</sup> / <sub>4</sub> x 10	<b>55.0034.6140</b>

**Glas S (VPE 6 Stk.) / glass S (unit 6 pcs.)**

Höhe	height	Inhalt	cap.
cm	in.	Ltr.	oz.
7,4	3	0,1	3,4
			<b>60.2506.9990</b>

**Milchkännchen / creamer**

Höhe	height	Inhalt	cap.
cm	in.	Ltr.	oz.
8,5	3 <sup>1</sup> / <sub>4</sub>	0,2	7
			<b>06.3806.6040</b>

**Zuckerstangengefäß / sugar pack holder**

Höhe	height	Ø	Ø
cm	in.	cm	in.
8,5	3 <sup>1</sup> / <sub>4</sub>	6	2 <sup>1</sup> / <sub>4</sub>
			<b>06.7120.6040</b>

Deckel mit Ausschnitt / lid with cut-out **55.0031.6040**

Espresso-/Mokkalöffel (VPE 12 Stk.) / demi-tasse spoon (unit 12 pcs.) **54.9901.6040**

\* Artikel einzeln bestellen / please order articles separately





## Milch-Zucker-Set, 4tlg.

### PURE EXCLUSIV

sugar and milk set, set of 4  
 service pots à lait / sucriers, en 4 parties  
 juego azucarero / cremera, 4 piezas  
 set lattiera zuccheriera, a 4 vaschette

in 2 Holzvarianten. Mit 4 Einsätzen für Gläser S oder Tassen S (o.Abb.) von KAFFEEKULTUR, Sahnekännchen und Zuckerdose von PURE oder Tassen S von CULTURECUP (o.Abb.). Nicht spülmaschinengeeignet! / in 2 wood versions. With 4 inserts for glasses S or cups S (w/o pic.) of CoffeeCulture or creamer and sugar basin of PURE or cups S of CultureCup (w/o pic.). Not dishwasher-safe!

Cromargan®, Holz dunkel gebeizt, Holz lackiert / stainless 18/10, wood dark stained, wood lacquered

#### Menage groß dunkel / stand large dark

Größe	size	
cm	in.	
14,5 x 14,5 x 25,4	5 <sup>3</sup> / <sub>4</sub> x 5 <sup>3</sup> / <sub>4</sub> x 10	<b>55.0034.6040</b>

#### Menage groß natur / stand large nature

Größe	size	
cm	in.	
14,5 x 14,5 x 25,4	5 <sup>3</sup> / <sub>4</sub> x 5 <sup>3</sup> / <sub>4</sub> x 10	<b>55.0034.6140</b>

#### Glas S (VPE 6 Stk.) / glass S (unit 6 pcs.)

Höhe	height	Inhalt	cap.	
cm	in.	Ltr.	oz.	
7,4	3	0,1	3,4	<b>60.2506.9990</b>

#### Zuckerdose, mit Deckel / sugar basin, with cover

Höhe	height	Inhalt	cap.	Ø	Ø	
cm	in.	Ltr.	oz.	cm	in.	
5,2	2	0,1	3,5	6	2 <sup>1</sup> / <sub>4</sub>	<b>06.2342.6040</b>

#### Milchkännchen / creamer

Höhe	height	Inhalt	cap.	
cm	in.	Ltr.	oz.	
8,5	3 <sup>1</sup> / <sub>4</sub>	0,2	7	<b>06.3806.6040</b>

#### Deckel mit Ausschnitt / lid with cut-out

**55.0031.6040**

#### Espresso-/Mokkalöffel (VPE 12 Stk.) / demi-tasse spoon (unit 12 pcs.)

**54.9901.6040**

\* Artikel einzeln bestellen / please order articles separately



**Kaffeetablett**

**PURE**

serving tray  
 plateau de service  
 bandeja  
 vassoio

stapelbar, oval /  
 stackable, oval

Cromargan® / stainless 18/10

Größe	size
cm	in.
27 x 17	10 <sup>1</sup> / <sub>2</sub> x 6 <sup>3</sup> / <sub>4</sub>

06.7550.6040



**Porzellanschale, 3-geteilt**

**PURE**

porcelain bowl 3-section  
 coupe en porcelaine 3 parties  
 cuenco de porcelana 3 divisiones  
 vassoietto tripartito portazzucchero

passend in Tablett 06.7551.6040 /  
 fitting in serving tray 06.7551.6040

Porzellan weiß / porcelain white

Größe	size
cm	in.
21 x 8,7 x 3,25	8 <sup>1</sup> / <sub>4</sub> x 3 <sup>1</sup> / <sub>2</sub> x 1 <sup>1</sup> / <sub>4</sub>

60.3538.9990



### Punchbowl CLASSIC

punch bowl  
bol à punch  
ponchera  
bowl per punch

Cromargan® / stainless 18/10

Höhe	height	Ø	Ø	Inhalt	cap.	
cm	in.	cm	in.	Ltr.	oz.	
29	11½	38,5	15¼	10	350	<b>06.0446.6040</b>

versilbert / silverplated

Höhe	height	Ø	Ø	Inhalt	cap.	
cm	in.	cm	in.	Ltr.	oz.	
29	11½	38,5	15¼	10	350	<b>19.0446.6440</b>



### Punchbowl PURE

punch bowl  
bol à punch  
ponchera  
bowl per punch

Cromargan® / stainless 18/10

Höhe	height	Ø	Ø		
cm	in.	cm	in.		
27	10¾	38	15		<b>06.0471.6040</b>



### Punchbowl NEUTRAL

punch bowl  
bol à punch  
ponchera  
bowl per punch

Cromargan® / stainless 18/10

Höhe	height	Ø	Ø	Inhalt	cap.	
cm	in.	cm	in.	Ltr.	oz.	
29	11½	38,5	15¼	10	350	<b>06.0449.6040</b>



**Getränkekühler****DIVA**

beverage cooler  
seau à boisson  
cubo bebida  
rinfresca bevanda

doppelwandig und stapelbar. Kann verwendet werden mit Kühlelement 55.0125.6040, für 3 Wasser-, Saft-, Milchkaraffen 06.1770.6040, 3 Getränkeflaschen (Bsp. Wasser, Wein, etc.) mit max. 10 cm Flaschendurchmesser, 6 Getränkeflaschen (Bsp. Wasser, Saft, Bier etc.) mit max. 7 cm Flaschendurchmesser /  
double wall and stackable. Can be used with cooling element 55.0125.6040, for 3 water/juice/milk decanter 06.1770.6040, 3 beverage bottles (e.g. water, wine, etc.) with max. 4 in. bottle diameter, 6 beverage bottles (e.g. water, juice, beer, etc.) with max. 2 3/4 in. bottle diameter

Cromargan® / stainless 18/10

Größe cm	size in.	Inhalt Ltr.	cap. oz.	
27,5 x 26,2 x 17	10 <sup>3</sup> / <sub>4</sub> x 10 <sup>1</sup> / <sub>4</sub> x 6 <sup>3</sup> / <sub>4</sub>	7,3	257	<b>55.0124.6040</b>



Das passende Kühlelement DIVA 55.0125.9990 finden Sie auf Seite 243.  
The matching cooling element DIVA 55.0125.9990 can be found on page 243.

**Wein-/Sektkühler****CLASSIC**

wine / champagne cooler  
seau à vin / champagne  
cubo vino / champán  
rinfrescavino / spumante

passend in Weinkühlerständer mit Durchmesser mind. 15 cm /  
fitting in stand for wine/champagne cooler with dia. 15 cm minimum

rund /  
round



Höhe cm	height in.	Inhalt Ltr.	cap. oz.	Cromargan® stainless 18/10	versilbert silverplated
20,8	8 <sup>1</sup> / <sub>4</sub>	4,3	151	<b>06.8190.6040</b>	<b>19.8190.6440</b>

**Wein-/Sektkühler****CLASSIC**

wine / champagne cooler  
seau à vin / champagne  
cubo vino / champán  
rinfrescavino / spumante

rund, für 2 Flaschen. Passend in Weinkühlerständer mit Durchm. mind. 20 cm /  
round, for 2 bottles. Fitting in stand for wine/champagne with dia. 20 cm minimum

Cromargan® / stainless 18/10

Höhe cm	height in.	Inhalt Ltr.	cap. oz.	
23,5	9 <sup>1</sup> / <sub>4</sub>	8	281	<b>06.8051.6040</b>





### Wein-/Sektküher

#### PURE

wine / champagne cooler  
seau à vin / champagne  
cubo vino / champán  
rinfrescavino / spumante

rund. Passend in Weinkühlerständer mit Durchm. mind. 16 cm /  
round. Fitting in stand for wine/champagne with dia. 16 cm minimum

Cromargan® / stainless 18/10

Höhe	height	Ø	Ø	Inhalt	cap.	
cm	in.	cm	in.	Ltr.	oz.	
22	8 <sup>3</sup> / <sub>4</sub>	19	7 <sup>1</sup> / <sub>2</sub>	4,7	165	<b>06.0469.6040</b>



### Weinkühler

#### URBAN

wine / champagne cooler  
seau à vin / champagne  
cubo vino / champán  
rinfrescavino / spumante

doppelwandig. Passend in Weinkühlerständer mit Durchm. mind. 16 cm. /  
double wall. Fitting in stand for wine/champagne with dia. 16 cm  
minimum.

Cromargan® / stainless 18/10

Höhe	height	Ø	Ø	Inhalt	cap.	
cm	in.	cm	in.	Ltr.	oz.	
24	9 <sup>1</sup> / <sub>2</sub>	16	6 <sup>1</sup> / <sub>4</sub>	3,2	113	<b>55.0064.6040</b>



### Wein-/Sektküher

#### NEUTRAL

wine / champagne cooler  
seau à vin / champagne  
cubo vino / champán  
rinfrescavino / spumante

rund. Passend in Weinkühlerständer mit Durchm. mind. 16 cm /  
round. Fitting in stand for wine/champagne with dia. 16 cm minimum

Cromargan® / stainless 18/10

Höhe	height	Inhalt	cap.	
cm	in.	Ltr.	oz.	
20,8	8 <sup>1</sup> / <sub>4</sub>	4,3	151	<b>06.8019.6040</b>



### Weinkühler

wine cooler  
seau à vin  
cubo vino  
rinfrescavino

doppelwandig. Passend in Weinkühlerständer mit Durchm. mind.  
12,5 cm /  
double wall. Fitting in stand for wine/champagne with dia. 12,5 cm  
minimum

Cromargan® / stainless 18/10

Höhe	height	Ø	Ø	Inhalt	cap.	
cm	in.	cm	in.	Ltr.	oz.	
19,5	7 <sup>3</sup> / <sub>4</sub>	12	4 <sup>3</sup> / <sub>4</sub>	1,6	56	<b>06.8239.6040</b>

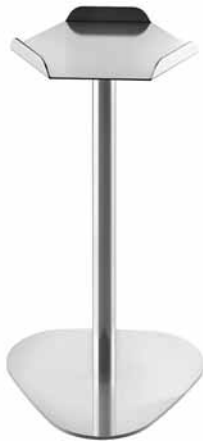

**Getränkekühlerständer**

**DIVA**

stand for beverage cooler  
support pour seau à boisson

Höhe cm	height in.	Ø Schale cm	dish Ø in.
59,5	23 1/2	30	11 3/4

55.0126.6040



**Weinkühlerständer**

**NEUTRAL**

stand for wine/champagne cooler  
support pour seau à champagne  
portacubos champán  
colonna per secchio spumante

rund /  
round

Höhe cm	height in.	Ø Schale cm	dish Ø in.
60	23 1/2	16	6 1/4

Cromargan® versilbert  
stainless 18/10 silverplated  
**06.8337.6040 19.8337.6440**



**Weinkühlerständer**

**NEUTRAL**

stand for wine/champagne cooler  
support pour seau à champagne  
portacubos champán  
colonna per secchio spumante

rund /  
round

Cromargan® / stainless 18/10

Höhe cm	height in.	Ø Schale cm	dish Ø in.
60	23 1/2	20	8

**06.8452.6040**

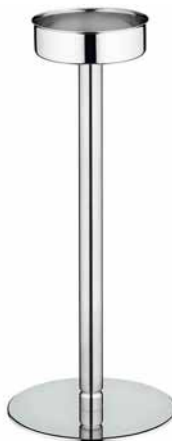

**Weinkühlerständer**

**PURE**

stand for wine/champagne cooler  
support pour seau à champagne  
portacubos champán  
colonna per secchio spumante

rund /  
round

Cromargan® / stainless 18/10

Höhe cm	height in.	Ø cm	Ø in.	Ø Schale cm	dish Ø in.
68,8	27	25	9 3/4	16	6 1/4

**06.0468.6040**





### Flaschenteller CLASSIC

coaster for bottles  
dessous de bouteille  
portabotella  
sottobottiglia

Ø Schale	dish Ø
cm	in.
10,5	4 <sup>1</sup> / <sub>4</sub>

Cromargan®	versilbert
stainless 18/10	silverplated
<b>06.2177.6040</b>	<b>19.2177.6440</b>

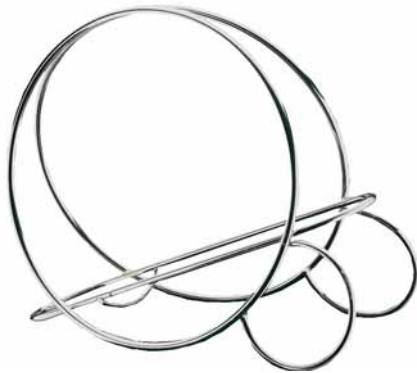

### Rotweinwiege

red wine cradle  
porte-bouteille  
portabottellas  
versavino

für Flasche 0,75 Ltr. /  
for bottle 26,3 oz.

verchromt / chromeplated

**06.8045.5080**



### Weinkorb

wine-basket  
panier à vin  
cesta vino  
cestino portavino

versilbert / silverplated

Größe	size	Höhe	height
cm	in.	cm	in.
23,5 x 10	9 <sup>1</sup> / <sub>4</sub> x 4	17,5	7

**19.2379.6440**



**Sauciere  
NEUTRAL**

gravy boat  
saucière  
salsera  
salsiere

auf Fuß /  
footed

Cromargan® / stainless 18/10

Inhalt	cap.
Ltr.	oz.
0,15	5,3
0,3	10,5
0,5	17,5

**06.6244.6040**  
**06.6245.6040**  
**06.6246.6040**



**Sauciere  
PURE**

gravy boat  
saucière  
salsera  
salsiere

auf Fuß, stapelbar /  
footed, stackable

Cromargan® teilmattiert / stainless 18/10 partly satin finished

Inhalt	cap.
Ltr.	oz.
0,2	7
0,5	17,5

**06.0473.6040**  
**06.0474.6040**



**Légumier  
CLASSIC**

vegetable dish and cover  
légumier et couvercle  
legumbrera con tapa  
legumiera con coperchio

Cromargan® / stainless 18/10

Ø	Ø	Inhalt	cap.
cm	in.	Ltr.	oz.
14	5½	0,35	12,3
14	5½		

Unterteil  
base  
**06.2701.6041**

Deckel  
cover  
**06.2701.6042**

versilbert / silverplated

Ø	Ø	Inhalt	cap.
cm	in.	Ltr.	oz.
14	5½	0,35	12,3
14	5½		

Unterteil  
base  
**19.2701.6441**

Deckel  
cover  
**19.2701.6442**



### Légumier NEUTRAL

vegetable dish and cover  
légumier et couvercle  
legumbreira con tapa  
legumiera con coperchio

Cromargan® / stainless 18/10

Ø cm	Ø in.	Inhalt Ltr.	cap. oz.	Unterteil base	Deckel cover
14	5½	0,35	12,3	<b>06.2786.6041</b>	
14	5½				<b>06.2786.6042</b>
16	6¼	0,6	21	<b>06.2787.6041</b>	
16	6¼				<b>06.2787.6042</b>



### Universalschale PURE

universal dish  
coupe universelle  
recipiente universal  
ciotola universale

stapelbar /  
stackable



Cromargan® teilmattiert / stainless 18/10 partly satin finished

Höhe cm	height in.	Ø Schale cm	dish Ø in.	
5,5	2¼	12	4¾	<b>06.1799.6040</b>

### Universalschale

finger bowl  
coupe universelle  
recipiente universal  
ciotola universale

Cromargan® / stainless 18/10

Inhalt Ltr.	cap. oz.	Ø Schale cm	dish Ø in.	
0,2	7	12	4¾	<b>06.1849.6040</b>



### Butterkühler CLASSIC

butter cooler  
refraîchisseur à beurre  
enfriador para mantequilla  
rinfresca-burro

Höhe cm	height in.	Ø cm	Ø in.	Cromargan® stainless 18/10	versilbert silverplated
8	3¼	5,5	2¼	<b>06.1090.6040</b>	<b>19.1090.6440</b>

Ersatzteil / spare part:  
Porzellanunterteil / porcelain base

60.3038.0690





### Butterkühler CLASSIC

butter cooler  
refraîchisseur à beurre  
enfriador para mantequilla  
rinfresca-burro

mit Unterteller /  
with underliner

Cromargan® / stainless 18/10

Höhe cm	height in.	Ø cm	Ø in.
6	2 <sup>1</sup> / <sub>4</sub>	15,5	6

**06.1087.6040**

Ersatzteil / spare part:

Unterteil / base 06.1085.6041

Einsatzsieb / sieve 06.1085.6044

Cloche / cover 06.1087.6042

Unterteller / underliner 06.1087.6043



### Butterkühler NEUTRAL

butter cooler  
refraîchisseur à beurre  
enfriador para mantequilla  
rinfresca-burro

mit Unterteller /  
with underliner

Cromargan® / stainless 18/10

Höhe cm	height in.	Ø cm	Ø in.
6,5	2 <sup>1</sup> / <sub>2</sub>	14,5	5 <sup>3</sup> / <sub>4</sub>

**06.1089.6040**

Ersatzteil / spare part:

Einsatzsieb / sieve 06.1089.6044

Unterteller / underliner 06.1089.6043



### Butterkühler CLASSIC

butter cooler  
refraîchisseur à beurre  
enfriador para mantequilla  
rinfresca-burro

	Ø cm	Ø in.
Unterteil / base	12	4 <sup>3</sup> / <sub>4</sub>
Einsatz / sieve		

Cromargan® stainless 18/10	versilbert silverplated
<b>06.3847.6041</b>	<b>19.3847.6441</b>
<b>06.1082.6044</b>	<b>19.1082.6444</b>



### Butterkühler

butter cooler  
refraîchisseur à beurre  
enfriador para mantequilla  
rinfresca-burro

Cromargan® / stainless 18/10

	Inhalt Ltr.	cap. oz.	Ø Schale cm	dish Ø in.
Universalschale / finger bowl	0,2	7	12	4 <sup>3</sup> / <sub>4</sub>
Einsatz / sieve				

06.1849.6040

06.1082.6044



### Dessertgestell PURE EXCLUSIV

dessert stand  
présentoir à gâteau  
soporte plato postre  
porta piattini per dessert

in 2 Holzvarianten. Mit 3 Einsätzen für wahlweise Gläser S, Tassen S oder Sahnekännchen (o. Abb.) von KaffeeKultur und Tassen S von CultureCup (o. Abb.). Nicht spülmaschinengeeignet! (ohne Gläser) /  
in 2 wood versions. With 3 inserts alternatively for glasses S, cups S or creamer (w/o pic.) of CoffeeCulture and cups S CultureCup (w/o pic.).  
Not dishwasher-safe! (w/o glasses)

Cromargan®, Holz dunkel gebeizt, Holz lackiert /  
stainless 18/10, wood dark stained, wood lacquered

Menage klein dunkel / stand small dark

Größe cm	size in.	
20,5 x 6,2 x 3,7	8 x 2 <sup>1</sup> / <sub>2</sub> x 1 <sup>1</sup> / <sub>2</sub>	55.0039.6040

Menage klein natur / stand small nature

Größe cm	size in.	
20,5 x 6,2 x 3,7	8 x 2 <sup>1</sup> / <sub>2</sub> x 1 <sup>1</sup> / <sub>2</sub>	55.0039.6140



Glas S (VPE 6 Stk.) / glass S (unit 6 pcs.)

Höhe cm	height in.	Inhalt Ltr.	cap. oz.	
7,4	3	0,1	3,4	60.2506.9990

\* Artikel einzeln bestellen / please order articles separately

**Dessertgestell  
PURE EXCLUSIV**

dessert stand  
présentoir à gâteau  
soporte plato postre  
porta piattini per dessert



in 2 Holzvarianten. Mit 3 Einsätzen für wahlweise Gläser S, Tassen S (o. Abb.) oder Sahnekännchen von KaffeeKultur und Tassen S von CultureCup (o. Abb.). Nicht spülmaschinengeeignet! /  
in 2 wood versions. With 3 inserts alternatively for glasses S, cups S (w/o pic.) or creamer of CoffeeCulture and cups S of CultureCup (w/o pic.). Not dishwasher-safe!

Cromargan®, Holz dunkel gebeizt, Holz lackiert /  
stainless 18/10, wood dark stained, wood lacquered

Menage klein dunkel / stand small dark

Größe	size	
cm	in.	
20,5 x 6,2 x 3,7	8 x 2 <sup>1</sup> / <sub>2</sub> x 1 <sup>1</sup> / <sub>2</sub>	55.0039.6040

Menage klein natur / stand small nature

Größe	size	
cm	in.	
20,5 x 6,2 x 3,7	8 x 2 <sup>1</sup> / <sub>2</sub> x 1 <sup>1</sup> / <sub>2</sub>	55.0039.6140



Sahnekännchen (VPE 6 Stk.) / creamer (unit 6 pcs.)

Höhe	height	Inhalt	cap.	
cm	in.	Ltr.	oz.	
7	2 <sup>3</sup> / <sub>4</sub>	0,1	3,4	55.0033.9990

Deckel mit Ausschnitt / lid with cut-out 55.0031.6040

Espresso-/Mokkalöffel (VPE 12 Stk.) /  
demi-tasse spoon (unit 12 pcs.) 54.9901.6040

\* Artikel einzeln bestellen / please order articles separately

**Menage  
PURE EXCLUSIV**

menage  
menagère, à tapenades  
set 3 recipientes  
ménage per tapenade

in 2 Holzvarianten. Für Tapenade, Fleur de Sel oder Saucen und Dips /  
in 2 wood versions. For tapenade, fleur de sel or dips

Cromargan®, Holz dunkel gebeizt, Holz lackiert /  
stainless 18/10, wood dark stained, wood lacquered



Menage klein dunkel / stand small dark

Größe	size	
cm	in.	
20,5 x 6,2 x 3,7	8 x 2 <sup>1</sup> / <sub>2</sub> x 1 <sup>1</sup> / <sub>2</sub>	55.0039.6040

Menage klein natur / stand small nature

Größe	size	
cm	in.	
20,5 x 6,2 x 3,7	8 x 2 <sup>1</sup> / <sub>2</sub> x 1 <sup>1</sup> / <sub>2</sub>	55.0039.6140

Porzellanschälchen (VPE 6 Stk.) / porcelain bowl (unit 6 pcs.)

Höhe	height	Ø	Ø	Inhalt	cap.	
cm	in.	cm	in.	Ltr.	oz.	
4	1 <sup>1</sup> / <sub>2</sub>	5	2	0,04	1,4	55.0093.9990

Gewürzlöffel (VPE 12 Stk.) / spicy spoon (unit 12 pcs.)

Länge	length	
cm	in.	
7	2 <sup>3</sup> / <sub>4</sub>	54.9184.6040



\* Artikel einzeln bestellen / please order articles separately





### Dessertgestell

dessert stand  
présentoir à gâteau  
soporte plato postre  
porta piattini per dessert

ohne Gläser /  
w/o glasses

Cromargan® / stainless 18/10

Größe	size
cm	in.
40,6 x 7 x 4,9	16 x 2 <sup>3</sup> / <sub>4</sub> x 2

**06.8230.6040**

Zubehör / accessory:

Glas S (VPE 6 Stk.) / glass S (unit 6 pcs.)

60.2506.9990



### Dessertgestell

dessert stand  
présentoir à gâteau  
soporte platos postre  
porta piattini per dessert

passend für Teller bis Ø 16 cm (ohne Teller) /  
fitting for plates Ø 6<sup>1</sup>/<sub>4</sub> in. (without plates)

Cromargan® / stainless 18/10

Höhe	height	Ø	Ø	Ø Ring	Ø ring
cm	in.	cm	in.	cm	in.
25,5	10	18,5	7 <sup>1</sup> / <sub>4</sub>	10,5	4 <sup>1</sup> / <sub>4</sub>

**06.4397.6040**



### Serviergestell

serving stand  
présentoir à assiette  
soporte platos  
portapiatti

passend für Teller Ø 26 cm (ohne Teller) /  
fitting for plates Ø 10<sup>1</sup>/<sub>4</sub> in. (without plates)

Cromargan® / stainless 18/10

Höhe	height	Ø	Ø	Ø Ring	Ø ring
cm	in.	cm	in.	cm	in.
40	15 <sup>3</sup> / <sub>4</sub>	28,5	11 <sup>1</sup> / <sub>4</sub>	18,6	7 <sup>1</sup> / <sub>4</sub>

**06.4395.6040**



### Kaviarkühler CLASSIC

caviar cooler  
refraîchisseur à caviar  
enfriador caviar  
rinfresca-caviale

	Ø	Ø	Cromargan®	versilbert
	cm	in.	stainless 18/10	silverplated
Unterteil / base	12	4 <sup>3</sup> / <sub>4</sub>	<b>06.3847.6041</b>	<b>19.3847.6441</b>
Einsatz / insert			<b>06.3851.6044</b>	<b>19.3851.6444</b>
Glaseinsatz / glass insert				<b>19.9999.8617</b>



### Chillcup CLASSIC

chillcup  
chillcup  
copa cóctel mariscos  
chillcup

mit Ring und Metalleinsatz /  
with ring and metal insert

Ø	Ø	Inhalt	cap.
cm	in.	Ltr.	oz.
12	4 <sup>3</sup> / <sub>4</sub>	0,12	4,2

Unterteil / base  
Ring / ring

Cromargan® stainless 18/10	versilbert silverplated
<b>06.3847.6041</b>	<b>19.3847.6441</b>
<b>06.3853.6045</b>	<b>19.3853.6445</b>



### Chillcup CLASSIC

chillcup  
chillcup  
copa cóctel mariscos  
chillcup

mit Ring und Glaseinsatz /  
with ring and glass insert

Ø	Ø	Inhalt	cap.
cm	in.	Ltr.	oz.
12	4 <sup>3</sup> / <sub>4</sub>	0,12	4,2

Unterteil / base  
Ring / ring  
Glasschale / glass dish

Cromargan® stainless 18/10	versilbert silverplated
<b>06.3847.6041</b>	<b>19.3847.6441</b>
<b>06.3853.6045</b>	<b>19.3853.6445</b>
	<b>19.9999.8616</b>



### Eisschale

ice cream bowl  
coupe à glace  
copa helado  
coppa gelato

Cromargan® / stainless 18/10

Höhe	height	Ø	Ø	Inhalt	cap.	
cm	in.	cm	in.	Ltr.	oz.	
4,5	1 <sup>3</sup> / <sub>4</sub>	10,5	4 <sup>1</sup> / <sub>4</sub>	0,1	3,38	<b>55.0093.6040</b>



**Petits Fours-Ständer  
CLASSIC**

petits-fours-stand  
porte petits fours  
portapastas  
alzata porta dolci

Höhe	height	Ø	Ø	Cromargan®	versilbert
cm	in.	cm	in.	stainless 18/10	silverplated
13	5	15,5	6	<b>06.4379.6040</b>	<b>19.4379.6440</b>



**Mokkaétagère  
CLASSIC**

pastry stand  
porte petits fours  
portapastas  
alzata portadolci

2 Ebenen /  
2 levels

versilbert / silverplated

Höhe	height	Ø Schale	Ø bowl	
cm	in.	cm	in.	
21,5	8½	10,7 / 15,5	4¼ / 6	<b>19.6907.6440</b>



**Petits Fours-Ständer  
URBAN**

petits-fours-stand  
porte petits fours  
portapastas  
alzata porta dolci

Cromargan® / stainless 18/10

Höhe	height	Ø	Ø	
cm	in.	cm	in.	
8,7	3½	15	6	<b>55.0067.6040</b>



**Mokkaétagère  
URBAN**

pastry stand  
porte petits fours  
portapastas  
alzata porta dolci

Cromargan® / stainless 18/10

Höhe	height	Ø	Ø	
cm	in.	cm	in.	
13,3	5¼	20	7¾	<b>55.0066.6040</b>





**Petits Fours-Ständer  
PURE EXCLUSIV**

petits-fours-stand  
porte petits fours  
portapastas  
alzata porta dolci

in 2 Holzvarianten. **Metall-Aufsatz Petit-Fours und Tischnummerständer können flexibel getauscht werden.** Höhe Holzfuß 10 cm. Holzfuß nicht spülmaschinenfest! / in 2 wood versions. **Metal support for petits-fours or table number stand can be switched flexibly.** Height of wooden foot 10 cm / 4 in.. Wooden foot not dishwasher-safe!

Cromargan®, Holz dunkel gebeizt, Holz lackiert / stainless 18/10, wood dark stained, wood lacquered

Höhe	height	Ø	Ø
cm	in.	cm	in.
14	5½	15	6

Holzfuß dunkel / stand dark **55.0121.6040**

Holzfuß natur / stand nature **55.0121.6140**

Petits Fours-Aufsatz / petits-fours-support **55.0121.6042**

Tischnummerständer-Aufsatz / table number stand support **55.0121.6043**

\* Artikel einzeln bestellen / please order articles separately



**Petits Fours-Ständer  
PURE**

petits-fours-stand  
porte petits fours  
portapastas  
alzata porta dolci

Cromargan® teilmattiert / stainless 18/10 partly satin finished

Höhe	height	Ø	Ø
cm	in.	cm	in.
10,4	4	15	6

**06.0475.6040**



**Mokkaétagère, 2 tlg.  
PURE**

pastry stand, 2 parts  
porte petits fours, en 2 parties  
portapastas, de 2 pisos  
alzata portadolci, 2 piani

Cromargan® / stainless 18/10

Höhe	height	Ø	Ø	Ø Schale	Ø bowl
cm	in.	cm	in.	cm	in.
14,5	5¾	20	7¾	14 / 20	5½ / 8

**06.8254.6040**



### Mokkaétagère, 3-teilig

#### PURE

pastry stand, 3 parts  
 porte petits fours, en 3 parties  
 portapastas, de 3 pisos  
 alzata portadolci, 3 piani

Cromargan® / stainless 18/10

Höhe cm	height in.	Ø Schale cm	Ø bowl in.	
22,5	8 <sup>3</sup> / <sub>4</sub>	9 / 14 / 20	3 <sup>1</sup> / <sub>2</sub> / 5 <sup>1</sup> / <sub>2</sub> / 8	06.6903.6040



### Marmeladegestell

jam stand  
 support pour confiture  
 soporte para mermelada  
 supporto per confettura

mit 5 Ablageflächen mit max. Durchm. 4,9 cm, Vase mittig /  
 with 5 levels with dia. max. 2 in., flower vase in the middle

Cromargan® / stainless 18/10

Höhe cm	height in.	
20	7 <sup>3</sup> / <sub>4</sub>	06.8231.6040



### Porzellanschale, 3-geteilt

#### PURE

porcelain bowl 3-section  
 coupe en porcelaine 3 parties  
 cuenco de porcelana 3 divisiones  
 vassoietto tripartito portazzucchero

passend in Tablett 06.7551.6040 /  
 fitting in serving tray 06.7551.6040

Porzellan weiß / porcelain white

Größe cm	size in.	
21 x 8,7 x 3,25	8 <sup>1</sup> / <sub>4</sub> x 3 <sup>1</sup> / <sub>2</sub> x 1 <sup>1</sup> / <sub>4</sub>	60.3538.9990



### Toastständer

#### PURE

toast rack  
 support pour pain grillé  
 portatostadas  
 porta-toast

passend in Tablett 06.7551.6040 /  
 fitting in serving tray 06.7551.6040

Cromargan® / stainless 18/10

Größe cm	size in.	
20 x 8 x 6,5	8 x 3 <sup>1</sup> / <sub>4</sub> x 2 <sup>1</sup> / <sub>2</sub>	06.4280.6040



### Relish-Pickles-Gestell NEUTRAL

relish or condiment server  
service à relish  
porta aperitivos  
portasalatini / olive

Cromargan® / stainless 18/10

Höhe cm	height in.	Ø Schale cm	dish Ø in.
13	5	8	3 1/4

06.2829.6040



### Relish-Pickles-Gestell CLASSIC

relish or condiment server  
service à relish  
porta aperitivos  
portasalatini / olive

Höhe cm	height in.	Ø Schale cm	dish Ø in.	Cromargan® stainless 18/10	versilbert silverplated
19,5	7 3/4	8	3 1/4	06.2846.6040	19.2846.6440

### Eiswasserkrug URBAN

water pitcher  
carafe à l'eau  
jarra agua  
brocca per acqua

mit Eislippe /  
with ice-trap

Cromargan® / stainless 18/10

Höhe cm	height in.	Inhalt Ltr.	cap. oz.
18,5	7 1/4	1,5	50,7

06.3371.6041



### Eiswasserkrug SCALA

water pitcher  
carafe à l'eau  
jarra agua  
brocca per acqua

mit Eislippe /  
with ice-trap

Höhe cm	height in.	Inhalt Ltr.	cap. oz.	Cromargan® stainless 18/10	versilbert silverplated
23	9	1,9	67	06.1866.6041	19.1866.6441







### Eiswasserkrug

water pitcher  
carafe à l'eau  
jarra agua  
brocca per acqua

mit Eislippe /  
with ice-trap

Cromargan® / stainless 18/10

Höhe	height	Inhalt	cap.
cm	in.	Ltr.	oz.
22	8 <sup>3</sup> / <sub>4</sub>	1,5	52,5

06.1860.6040



### Eiswasserkrug

#### PURE

water pitcher  
carafe à l'eau  
jarra agua  
brocca per acqua

mit Eislippe /  
with ice-trap

Cromargan®, teil mattiert /  
stainless 18/10, partly satin finished

Höhe	height	Inhalt	cap.
cm	in.	Ltr.	oz.
20	8	1,9	66,5

06.1865.6040



### Eisgefäß

#### CLASSIC

ice bucket  
seau à glace  
cubo hielo  
secchiello da ghiaccio

mit Eiseinsatz /  
with grid

Cromargan® / stainless 18/10

Höhe	height	Inhalt	cap.
cm	in.	Ltr.	oz.
12	4 <sup>3</sup> / <sub>4</sub>	1,5	52,5

06.1761.6040



### Eisgefäß

#### NEUTRAL

ice bucket  
seau à glace  
cubo hielo  
secchiello da ghiaccio

Cromargan® / stainless 18/10

Höhe	height	Inhalt	cap.
cm	in.	Ltr.	oz.
12	4 <sup>3</sup> / <sub>4</sub>	1,5	52,5

06.1760.6040

**Eisgefäß  
URBAN**

ice bucket  
seau à glace  
cubo hielo  
secchiello da ghiaccio

doppelwandig /  
double wall

Cromargan® / stainless 18/10

Höhe	height	Ø	Ø
cm	in.	cm	in.
15	6	14	5½

55.0065.6040

**Eisgefäß  
PURE**

ice bucket  
seau à glace  
cubo hielo  
secchiello da ghiaccio

Cromargan® teilmattiert / stainless 18/10 partly satin finished

Höhe	height	Inhalt	cap.
cm	in.	Ltr.	oz.
15	6	1,5	52,5

06.1767.6040

**Eisgefäß**

ice bucket  
seau à glace  
cubo hielo  
secchiello da ghiaccio

doppelwandig /  
double wall

Cromargan® / stainless 18/10

Höhe	height	Ø	Ø	Inhalt	cap.
cm	in.	cm	in.	Ltr.	oz.
15	6	12,5	5	0,7	23,66

55.0035.6040



**Platzteller  
RESIDENCE**

plate tray  
assiette de présentation  
bajoplato  
piatto segnaposto

Cromargan® / stainless 18/10

Ø a	Ø a	Ø b	Ø b
cm	in.	cm	in.
33	13	19	7½

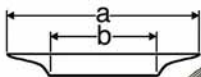
06.7473.6090\*

\* Rand geprägt / struck rim

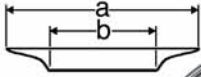

### Platzteller

plate tray  
 assiette de présentation  
 bajoplato  
 piatto segnaposto

Ø a	Ø a	Ø b	Ø b	Cromargan®	versilbert
cm	in.	cm	in.	stainless 18/10	silverplated
32	12½	19	7½	<b>06.7416.9990*</b>	<b>19.7416.6440*</b>
33	13	21	8¼	<b>06.7417.6040**</b>	

\* für Teller Ø 28 cm / for plates Ø 11 in.

\*\* für Teller Ø 30 cm / for plates Ø 11¾ in.



### Teller cloche CLASSIC

plate cover  
 cloche pour assiette  
 campana con pomo  
 copripiatto con pomolo

auflegend /  
 salient

Höhe	height	Ø Fond	Ø inside	Cromargan®	versilbert
cm	in.	cm	in.	stainless 18/10	silverplated
17	6¾	25	9¾	<b>06.7148.6040</b>	<b>19.7148.6440</b>



### Teller cloche NEUTRAL

plate cover  
 cloche pour assiette  
 campana con pomo  
 copripiatto con pomolo

auflegend /  
 salient

Cromargan® / stainless 18/10

Höhe	height	Ø Fond	Ø inside	
cm	in.	cm	in.	
16,5	6⅔	25	9¾	<b>06.7113.6040</b>



### Teller cloche

plate cover  
 cloche pour assiette  
 campana  
 copripiatto con pomolo

stapelbar /  
 stackable

Cromargan® / stainless 18/10

Höhe	height	Ø Fond	Ø inside	
cm	in.	cm	in.	
5,3	2	26	10¼	<b>06.7089.6040</b>
5,3	2	27,1	10¾	<b>06.7086.6040</b>
5,3	2	28	11	<b>06.7087.6040</b>





### Eierbecher-Set

egg cup set  
set de coquetier  
set de huevera  
set portauovo

stapelbar /  
stackable

Cromargan® / stainless 18/10  

Ø	Ø	Stück
cm	in.	pcs.
8,5	3 1/3	6

06.1640.6040



### Eierlöffel

egg spoon  
cuiller à oeuf  
cuchara huevos  
cucchiaio per uovo

Cromargan® / stainless 18/10  

Länge	length
cm	in.
13	5

12.9008.6040\*

\* VPE 12 Stk. / unit 12 pcs.



### Tischrestebehälter PURE

silent waiter  
boîte de table  
recipiente desperdicios  
porta rifiuti per tavolo

Deckel zum Abnehmen, auch als Kühler für kleine Flaschen einsetzbar,  
stapelbar /  
detachable lid, can also be used to cool small bottles, stackable

Cromargan® teilmattiert / stainless 18/10 partly satin finished

Höhe	height	Ø	Ø
cm	in.	cm	in.
15	6	14	5 1/2

06.1758.6040



### Krümelsammler

table crumbler  
ramasse-brosse  
recogemigas  
raccoglibriciole

Cromargan® / stainless 18/10  

Länge	length
cm	in.
15	6

06.7707.6000



### Zahnstocherbehälter

#### CLASSIC

toothpick-holder  
porte-cure-dents  
palillero  
porta stuzzicadenti

Höhe	height
cm	in.
6	2 <sup>1</sup> / <sub>4</sub>

rostfrei	versilbert
stainless steel	silverplated
<b>06.8406.1680</b>	<b>19.8406.1440</b>



### Zahnstocherbehälter

#### PURE

toothpick-holder  
porte-cure-dents  
palillero  
porta stuzzicadenti

Cromargan®, teilmattiert /  
stainless 18/10, partly satin finished

Höhe	height
cm	in.
7	2 <sup>3</sup> / <sub>4</sub>

**06.8413.6040**



### Zahnstocher- und Süßstoffbehälter

#### PURE

toothpick- and sweetener box-holder  
porte-cure-dents et récipient pour sucrées  
palillero y dispensador de edulcorante  
porta stuzzicadenti e contenitore per dolcificante

zum Einhängen in alle WMF PURE-Gestelle mit Bügelgriff.  
Laser-Gravur der Tischnummer nach Wunsch - Preis auf Anfrage /  
fitting in all racks of WMF PURE sets. Engraving of the table No. on  
request - please ask for respective costs

Cromargan® / stainless 18/10

Höhe	height
cm	in.
4	1 <sup>1</sup> / <sub>2</sub>

**06.1905.6044**



### Ascher

#### PURE

ash tray  
cendrier  
cenicero  
posacenere

stapelbar /  
stackable

Cromargan®, teilmattiert /  
stainless 18/10, partly satin finished

Höhe	height	Ø	Ø
cm	in.	cm	in.
5	2	14	5 <sup>1</sup> / <sub>2</sub>

**06.5552.6040**

**Zigarrenabschneider**

cigar cutter  
coupe-cigares  
cortapuros  
spuntasigari

Edelstahl 18/10 / stainless 18/10

Länge	length
cm	in.
10	4

55.0094.6040

**Tischnummernständer  
CLASSIC**

table number stand  
porte numéro de table  
porta número de mesa  
targhetta ad appoggio per numero tavolo

individuelle Gravur nach Wunsch - Preis auf Anfrage. Tischnummer nicht entfernbar. /  
individual engraving on request - please ask for respective costs. Table number not removable.

Cromargan® / stainless 18/10

Höhe	height
cm	in.
54	21 <sup>1</sup> / <sub>4</sub>

06.7819.6040

**Tischnummernständer, mit Clip  
CLASSIC**

table number stand, with clip  
porte numéro de table, avec clip  
porta número de mesa, con clip  
segnatavola, con clip

Tischnummer separat zum Einstecken. /  
Table No. to be put in separately.

Cromargan® / stainless 18/10

Höhe	height	Ø	Ø
cm	in.	cm	in.
45,4	17 <sup>3</sup> / <sub>4</sub>	9,7	3 <sup>3</sup> / <sub>4</sub>

06.8250.6040

Zubehör / accessory:

Tischnummer / table number

06.8252.6040

Plastik-Tischnummer / plastic table number

19.9999.2513





### Tischnummernständer

#### PURE

table number stand  
 porte numéro de table  
 porta número de mesa (sin número)  
 segnatavola

Cromargan®, teilmattiert /  
 stainless 18/10, partly satin finished

Höhe	height
cm	in.
30,5	12

06.7812.6040

Zubehör / accessory:

Plastik-Tischnummer / plastic table number  
 Tischnummer / table number

19.9999.2513  
 06.8252.6040



### Tischnummernständer

#### PURE EXCLUSIV

table number stand  
 porte numéro de table  
 porta número de mesa  
 segnatavola

in 2 Holzvarianten. **Metall-Aufsatz Petit-Fours und Tischnummernständer kann flexibel getauscht werden.** Holzfuß nicht spülmaschinenfest! /

in 2 wood versions. **Metal part for petits-fours or table number stand can be switched flexibly.** Wooden foot not dishwasher-safe!

Cromargan®, Holz dunkel gebeizt, Holz lackiert /  
 stainless 18/10, wood dark stained, wood lacquered

Höhe	height
cm	in.
36,8	14 <sup>1</sup> / <sub>2</sub>

Holzfuß dunkel / stand dark

55.0121.6040

Holzfuß natur / stand nature

55.0121.6140

Petits Fours-Aufsatz / petits-fours-support

55.0121.6042

Tischnummernständer-Aufsatz / table number stand support

55.0121.6043

\* Artikel einzeln bestellen / please order articles separately



**Kartenhalter  
PURE EXCLUSIV**

card holder  
porte-carte  
portatarjetas  
portacarta

in 2 Holzvarianten. Für Tisch- und Visitenkarten (ohne Karte) /  
in 2 wood versions. For menu and name cards (without card)

Cromargan®, Holz dunkel gebeizt, Holz lackiert /  
stainless 18/10, wood dark stained, wood lacquered

Kartenhalter dunkel / card holder dark

Größe	size	
cm	in.	
4,5 x 4,5 x 6,5	1 3/4 x 1 3/4 x 2 1/2	<b>55.0080.6040</b>

Kartenhalter natur / card holder nature

Größe	size	
cm	in.	
4,5 x 4,5 x 6,5	1 3/4 x 1 3/4 x 2 1/2	<b>55.0080.6140</b>



**Speisekartenhalter  
PURE**

menu stand  
porte menu  
porta menus  
portamenu

Cromargan®, teilmattiert /  
stainless 18/10, partly satin finished

Höhe	height	
cm	in.	
7,5	3	<b>06.7813.6040</b>

Zubehör / accessory:

Plastik-Tischnummer / plastic table number	19.9999.2513
Tischnummer / table number	06.8252.6040

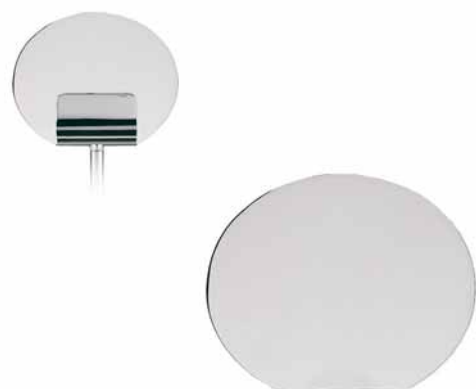

**Tischnummer**

table number  
numéro de table  
número de mesa  
numero tavolo

passend zu Tischnummernständer 06.8250.6040, 06.7812.6040,  
55.0121.6043 und Speisekartenhalter 06.7813.6040. Individuelle Gravur  
nach Wunsch - Preis auf Anfrage /  
fitting for table number stand 06.8250.6040,  
06.7812.6040, 55.0121.6043 and menu stand 06.7813.6040. Individual  
engraving on request - please ask for respective costs

Cromargan® / stainless 18/10

Ø	Ø	
cm	in.	
13,5	5 1/4	<b>06.8252.6040</b>



### Plastik-Tischnummer

plastic table number  
numéro de table en plastique  
número de mesa plástico  
numero tavolo in plastica

passend in Tischnummernständer 06.7812.6040, 06.8250.6040,  
55.0121.6043 und Speisekartenhalter 06.7813.6040 /  
fitting in table number stand 06.7812.6040, 06.8250.6040,  
55.0121.6043 and menu stand 06.7813.6040

Größe	size
cm	in.
10 x 10	4 x 4

19.9999.2513



### Tischnummern-Aufsteller

table number  
numéro de table  
número de mesa  
numero tavolo

Laser-Gravur nach Wunsch - Preis auf Anfrage /  
engraving on request - please ask for respective costs

Höhe	height	Länge	length	Cromargan®	versilbert
cm	in.	cm	in.	stainless 18/10	silverplated
3,6	1½	8,3	3¼	<b>06.7701.6040</b>	<b>19.7701.6440</b>



### Dosenöffner

can opener  
ouvre-boîte  
abrelatas  
abriscatole

ganz Metall. Hinterlässt keine scharfen Kanten am Dosendeckel, Deckel kann wieder aufgesetzt werden. /  
all metal. Does not leave sharp edges on the can lid - lid can be replaced on can.

Cromargan® / stainless 18/10

Länge	length
cm	in.
20	8

18.7319.6040



### Korkenzieher

cork-screw  
tire-bouchon  
sacacorchos  
cavatappi

Cromargan® / stainless 18/10

Länge	length
cm	in.
17,5	7

18.8252.6019





**Früchtekorb**

fruit basket  
panier à fruits  
frutero  
fruttiera

passend in Etagère 06.3010.6040, 06.3011.6040 nur in Verbindung mit  
Kühlbehälter 06.3014.6045 (bitte separat bestellen) /  
fitting together with cooler 06.3014.6045 (please order separately) in  
etagere 06.3010.6040, 06.3011.6040

Cromargan® / stainless 18/10

Höhe	height	Ø	Ø
cm	in.	cm	in.
22,5	8 <sup>3</sup> / <sub>4</sub>	26	10 <sup>1</sup> / <sub>4</sub>

**06.6521.6040**



**Brotkorb, rund  
OLE PALSBY**

bread-basket, round  
panier à pain, rond  
cesta del pan, redonda  
cestino per il pane, rotondo

Cromargan® / stainless 18/10

Ø	Ø
cm	in.
18	7 <sup>1</sup> / <sub>2</sub>
21	8 <sup>1</sup> / <sub>4</sub>
26	10 <sup>1</sup> / <sub>4</sub>

**06.6575.6040**

**06.6513.6040**

**06.6514.6040**



**Brotkorb  
PURE**

bowl for bread  
panier à pain  
panera  
portapane

stapelbar /  
stackable

Cromargan® teilmattiert / stainless 18/10 partly satin finished

Größe	size
cm	in.
25 x 14 x 5	9 <sup>3</sup> / <sub>4</sub> x 5 <sup>1</sup> / <sub>2</sub> x 2

**06.6535.6040**



### Brotkorb

bread-basket  
panier à pain  
cesta del pan  
cestino per il pane

nicht mit Wasser oder Chemikalien reinigen. Reinigung nur im Silbertauchbad oder mit speziellen Pflegemitteln für Silberartikel / do not clean with water or chemicals. Cleaning only in silver-dip-bath or with special polish for silver articles

versilbert / silverplated

Größe	size	
cm	in.	
22,3 x 16,3 x 6	8 <sup>3</sup> / <sub>4</sub> x 6 <sup>1</sup> / <sub>2</sub> x 2 <sup>1</sup> / <sub>4</sub>	
27 x 19 x 6,5	10 <sup>3</sup> / <sub>4</sub> x 7 <sup>1</sup> / <sub>2</sub> x 2 <sup>1</sup> / <sub>2</sub>	

**19.6319.7030**  
**19.6329.6440**



### Brotchale

bowl for bread  
panier à pain  
panera  
portapane

Cromargan® / stainless 18/10

Größe	size	
cm	in.	
22,5 x 22,5 x 7,2	8 <sup>3</sup> / <sub>4</sub> x 8 <sup>3</sup> / <sub>4</sub> x 2 <sup>3</sup> / <sub>4</sub>	

**06.8236.6040**



### Brotchale

bowl for bread  
panier à pain  
panera  
portapane

Größe	size	
cm	in.	
28 x 17	11 x 6 <sup>3</sup> / <sub>4</sub>	

Cromargan®	versilbert
stainless 18/10	silverplated
<b>06.6380.6040</b>	<b>19.6380.6440</b>



### Brotchale

bowl for bread  
panier à pain  
panera  
portapane

oval, Durchbruchdekor /  
oval, stencil pattern

Cromargan® / stainless 18/10

Größe	size
cm	in.
20 x 15	8 x 6

**06.6571.6040**



**Obstschale****BISTRO**

fruit stand  
coupe à fruits  
frutero  
alzata per frutta

Cromargan®, Glas / stainless 18/10, glass

Höhe	height	Ø Schale	Ø bowl
cm	in.	cm	in.
16	6 <sup>1</sup> / <sub>4</sub>	38	15

**06.6895.6040**

Ersatzteil / spare part:

Glasschale mittel / glass plate medium

19.9999.8644

**Universalschale****PURE**

universal dish  
coupe universelle  
recipiente universal  
ciotola universale

stapelbar /  
stackable



Cromargan® teilmattiert / stainless 18/10 partly satin finished

Höhe	height	Ø Schale	dish Ø
cm	in.	cm	in.
5,5	2 <sup>1</sup> / <sub>4</sub>	12	4 <sup>3</sup> / <sub>4</sub>

**06.1799.6040****Universalschale**

finger bowl  
coupe universelle  
recipiente universal  
ciotola universale

Cromargan® / stainless 18/10

Inhalt	cap.	Ø Schale	dish Ø
Ltr.	oz.	cm	in.
0,2	7	12	4 <sup>3</sup> / <sub>4</sub>

**06.1849.6040**





**Leuchter  
CLASSIC**

candle stick  
chandelier  
candelero  
candeliere

versilbert / silverplated

Höhe	height
cm	in.
12	4 <sup>3</sup> / <sub>4</sub>

19.4990.6440



**Leuchter  
PURE**

candle stick  
chandelier  
candelero  
candeliere

Cromargan®, teilmattiert /  
stainless 18/10, partly satin finished

Höhe	height
cm	in.
10,5	4 <sup>1</sup> / <sub>4</sub>

06.4751.6040



**Leuchter  
URBAN**

candle stick  
chandelier  
candelero  
candeliere

Cromargan® / stainless 18/10

Höhe	height	Länge	length
cm	in.	cm	in.
21	8 <sup>1</sup> / <sub>4</sub>	6,4	2 <sup>1</sup> / <sub>2</sub>

55.0060.6040



**Leuchter  
PURE EXCLUSIV**

candle stick  
chandelier  
candelero  
candeliere

Cromargan®, Holz dunkel gebeizt /  
stainless 18/10, wood dark stained

Höhe	height	Ø	Ø
cm	in.	cm	in.
20,4	8	9	3 <sup>1</sup> / <sub>2</sub>
30,4	12	9	3 <sup>1</sup> / <sub>2</sub>

55.0018.6040

55.0017.6040



**Leuchter, 3-flammig  
URBAN**

candelabra, 3-branched  
chandelier, 3 branches  
candelabro, 3 brazos  
candelieri, 3 fiamme

Cromargan® / stainless 18/10

Höhe cm	height in.	Länge cm	length in.
22,5	8 <sup>3</sup> / <sub>4</sub>	23,8	9 <sup>1</sup> / <sub>4</sub>

55.0069.6040



**Leuchter, 3-armig  
PURE**

candelabra, 3-branched  
chandelier, 3 branches  
candelabro, 3 brazos  
candelieri, 3 fiamme

Cromargan®, teilmattiert /  
stainless 18/10, partly satin finished

Höhe cm	height in.
36	14 <sup>1</sup> / <sub>4</sub>

06.4753.6040



**Leuchter, 5-armig  
PURE**

candelabra, 5-branched  
chandelier, 5 branches  
candelabro, 5 brazos  
candelieri, 5 fiamme

Cromargan®, teilmattiert /  
stainless 18/10, partly satin finished

Höhe cm	height in.
36	14 <sup>1</sup> / <sub>4</sub>

06.4754.6040



**Windlicht  
URBAN**

table lamp  
chandelier avec verrine  
linternas con cristal  
lampa da tavola alta con paralume

ohne Kerzen. Für große Teelichter /  
w/o candles. For big tealights

Cromargan®, Glas / stainless 18/10, glass

Höhe	height	Ø	Ø
cm	in.	cm	in.
13,5	5 <sup>1</sup> / <sub>4</sub>	8	3 <sup>1</sup> / <sub>4</sub>

**55.0070.6040**

Ersatzteil / spare part:

Ersatzglas zu Windlicht / spare glass for table lamp

55.0070.9990



**Windlicht  
PURE**

table lamp with glass  
chandelier avec verrine  
linternas con cristal  
lampa da tavola alta con paralume

ohne Kerzen. Für Teelichter /  
w/o candles. For tealights

Cromargan®, teilmattiert, Glas /  
stainless 18/10, partly satin finished, glass

Höhe	height
cm	in.
21	8 <sup>1</sup> / <sub>4</sub>

**06.8202.6040**

Ersatzteil / spare part:

Ersatzglas / spare glass

60.3051.9990



**Windlicht, matt  
PURE**

table lamp with glass, satin  
chandelier avec verrine, mat  
linternas con cristal, mate  
lampa da tavola alta con paralume, di vetro satinato

ohne Kerzen. Für Teelichter /  
w/o candles. For tealights

Cromargan®, teilmattiert, Glas /  
stainless 18/10, partly satin finished, glass

Höhe	height
cm	in.
21	8 <sup>1</sup> / <sub>4</sub>

**06.8208.6040**

Ersatzteil / spare part:

Ersatzglas / spare glass

60.3052.9990





**Windlicht, groß  
PURE EXCLUSIV**

table lamp, large  
chandelier avec verrine, grand  
linternas con cristal, alta  
lampa da tavola alta con paralume, grande

in 2 Holzvarianten. Ohne Kerzen. Für große Teelichter. Nicht spülmaschinengeeignet! /  
in 2 wood versions. W/o candles. For big tealights. Not dishwasher-safe!

Cromargan®, Holz dunkel gebeizt, Holz lackiert, Glas satiniert / stainless 18/10, wood dark stained, wood lacquered, glass satin finished

**Windlicht, groß dunkel / table lamp, large dark**

Größe	size	Ø	Ø	
cm	in.	cm	in.	
8 x 8 x 22,3	3 <sup>1</sup> / <sub>4</sub> x 3 <sup>1</sup> / <sub>4</sub> x 8 <sup>3</sup> / <sub>4</sub>	13	5	<b>55.0040.6040</b>

**Windlicht, groß natur / table lamp, large nature**

Größe	size	Ø	Ø	
cm	in.	cm	in.	
8 x 8 x 22,3	3 <sup>1</sup> / <sub>4</sub> x 3 <sup>1</sup> / <sub>4</sub> x 8 <sup>3</sup> / <sub>4</sub>	13	5	<b>55.0040.6140</b>

Ersatzteil / spare part:

Ersatzglas zu Windlicht groß / spare glass for table lamp large	<b>55.0040.6042</b>
--	---------------------



**Windlicht, klein  
PURE EXCLUSIV**

table lamp, small  
chandelier avec verrine, petit  
linternas con cristal, pequeno  
lampa da tavola alta c. paralum, picc.

in 2 Holzvarianten. Ohne Kerzen. Für Teelichter. Nicht spülmaschinengeeignet! /  
in 2 wood versions. W/o candles. For tealights. Not dishwasher-safe!

Cromargan®, Holz dunkel gebeizt, Holz lackiert, Glas satiniert / stainless 18/10, wood dark stained, wood lacquered, glass satin finished

**Windlicht, klein dunkel / table lamp, small dark**

Größe	size	Ø	Ø	
cm	in.	cm	in.	
6,3 x 6,3 x 19,3	2 <sup>1</sup> / <sub>2</sub> x 2 <sup>1</sup> / <sub>2</sub> x 7 <sup>1</sup> / <sub>2</sub>	9,5	3 <sup>3</sup> / <sub>4</sub>	<b>55.0075.6040</b>

**Windlicht, klein natur / table lamp, small nature**

Größe	size	Ø	Ø	
cm	in.	cm	in.	
6,3 x 6,3 x 19,3	2 <sup>1</sup> / <sub>2</sub> x 2 <sup>1</sup> / <sub>2</sub> x 7 <sup>1</sup> / <sub>2</sub>	9,5	3 <sup>3</sup> / <sub>4</sub>	<b>55.0075.6140</b>

Ersatzteil / spare part:

Ersatzglas zu Windlicht klein / spare glass for table lamp small	<b>55.0075.6042</b>
---	---------------------



**Teelichtleuchter 3fl. klein  
PURE EXCLUSIV**

tealight candle stick, small  
chandelier bougie à chauffe-plat  
candelero lamparilla, peq.  
candeliere lumino, picc.

in 2 Holzvarianten. Mit 3 Einsätzen für Teelichter, Stab- oder  
Stumpenkerzen. Nicht spülmaschinengeeignet! /  
in 2 wood versions. With 3 inserts for tealights and other kinds of  
candles. Not dishwasher-safe!

Cromargan®, Holz dunkel gebeizt, Holz lackiert /  
stainless 18/10, wood dark stained, wood lacquered

Menage klein dunkel / stand small dark

Größe	size	
cm	in.	
20,5 x 6,2 x 3,7	8 x 2 <sup>1</sup> / <sub>2</sub> x 1 <sup>1</sup> / <sub>2</sub>	

**55.0039.6040**

Menage klein natur / stand small nature

Größe	size	
cm	in.	
20,5 x 6,2 x 3,7	8 x 2 <sup>1</sup> / <sub>2</sub> x 1 <sup>1</sup> / <sub>2</sub>	

**55.0039.6140**



**Blumenvase  
CLASSIC**

flower vase  
vase à fleurs  
florero  
vaso da fiori

versilbert / silverplated

Höhe	height
cm	in.
16,5	6 <sup>1</sup> / <sub>2</sub>

19.7962.1440



**Blumenvase  
URBAN**

flower vase  
vase à fleurs  
florero  
vaso da fiori

Cromargan® / stainless 18/10

Höhe	height	Ø	Ø
cm	in.	cm	in.
17,5	7	7	2 <sup>3</sup> / <sub>4</sub>

55.0061.6040



**Blumenvase  
PURE**

flower vase  
vase à fleurs  
florero  
vaso da fiori

Cromargan®, teilmattiert /  
stainless 18/10, partly satin finished

Höhe	height
cm	in.
20	8

06.7955.6040



**Blumenvase**

flower vase  
vase à fleurs  
florero  
vaso da fiori

Cromargan® / stainless 18/10

Höhe	height	Ø	Ø
cm	in.	cm	in.
30	11 <sup>3</sup> / <sub>4</sub>	10	4

06.8240.6040





### Blumenvase, klein

#### PURE EXCLUSIV

flower vase, small  
vase à fleurs, petit  
florero, pequeño  
vaso da fiori, piccolo

in 2 Holzvarianten. Für einzelne Blüten. Nicht spülmaschinengeeignet! /  
in 2 wood versions. For single flowers. Not dishwasher-safe!

Cromargan®, Holz dunkel gebeizt, Holz lackiert /  
stainless 18/10, wood dark stained, wood lacquered

Blumenvase, klein dunkel / flower vase, small dark

Größe	size	Ø	Ø	
cm	in.	cm	in.	
4,5 x 4,5 x 16	1 <sup>3</sup> / <sub>4</sub> x 1 <sup>3</sup> / <sub>4</sub> x 6 <sup>1</sup> / <sub>4</sub>	2,8	1	55.0041.6040

Blumenvase, klein natur / flower vase, small nature

Größe	size	Ø	Ø	
cm	in.	cm	in.	
4,5 x 4,5 x 16	1 <sup>3</sup> / <sub>4</sub> x 1 <sup>3</sup> / <sub>4</sub> x 6 <sup>1</sup> / <sub>4</sub>	2,8	1	55.0041.6140



### Blumenvase, groß

#### PURE EXCLUSIV

flower vase, large  
vase à fleurs, grande  
florero, grande  
vaso da fiori, grande

in 2 Holzvarianten. Nicht spülmaschinengeeignet! /  
in 2 wood versions. Not dishwasher-safe!

Cromargan®, Holz dunkel gebeizt, Holz lackiert /  
stainless 18/10, wood dark stained, wood lacquered

Blumenvase, groß dunkel / flower vase, large dark

Größe	size	Ø	Ø	
cm	in.	cm	in.	
8 x 8 x 23,5	3 <sup>1</sup> / <sub>4</sub> x 3 <sup>1</sup> / <sub>4</sub> x 9 <sup>1</sup> / <sub>4</sub>	5,2	2	55.0042.6040

Blumenvase, groß natur / flower vase, large nature

Größe	size	Ø	Ø	
cm	in.	cm	in.	
8 x 8 x 23,5	3 <sup>1</sup> / <sub>4</sub> x 3 <sup>1</sup> / <sub>4</sub> x 9 <sup>1</sup> / <sub>4</sub>	5,2	2	55.0042.6140



**Salzmühle / Pfeffermühle**

salt mill / pepper mill  
 moulin à sel / moulin à poivre  
 molinillo sal / molinillo pimienta  
 macinasale / macinapepe

mit original Keramikmahlwerk /  
 with ceramic grinding mechanism

Cromargan®, Acrylglas / stainless 18/10, acrylic glass

Höhe	height	Ø	Ø
cm	in.	cm	in.
12	4¾	5	2
16	6¼	5	2

**06.1510.6040**  
**06.3531.6040**



**Salzmühle / Pfeffermühle**

salt mill / pepper mill  
 moulin à sel / moulin à poivre  
 molinillo sal / molinillo pimienta  
 macinasale / macinapepe

mit original Keramikmahlwerk. Passend in die großen Ausschnitte der  
 Menagen PURE EXCLUSIV /  
 with ceramic grinding mechanism. Fitting in the big cut-outs of the  
 stands high PURE EXCLUSIV

Cromargan®, Holz lackiert / stainless 18/10, wood lacquered

Höhe	height
cm	in.
19	7½

Salzmühle / Pfeffermühle weiß / salt mill / pepper mill  
 white

**06.6708.4500**

Salzmühle / Pfeffermühle schwarz / salt mill / pepper mill  
 black

**06.6709.4500**



**Salzstreuer / Pfefferstreuer**  
**URBAN**

salt shaker / pepper shaker  
 moulin à sel / moulin à poivre  
 molinillo sal / molinillo pimienta  
 macinasale / macinapepe

einzelnd stehend oder passend auf Tablett URBAN oder in kleine  
 Ausschnitte von PURE EXCLUSIV Teelichthalter und Menage. /  
 stand alone or fitting on tray URBAN or in small cut-outs of PURE  
 EXCLUSIV tealight holder or menage

Cromargan® / stainless 18/10

Höhe	height	Ø	Ø
cm	in.	cm	in.
8,5	3¼	4,5	1¾

Salzstreuer / salt shaker

**55.0062.6040**

Pfefferstreuer / pepper shaker

**55.0063.6040**

Ersatzteil / spare part:

Stopfen zu Streuer / stopper for shakers

**55.0062.9502**



### Salz- und Pfeffergestell CLASSIC

salt-pepper-set  
ménagère 2 pièces  
servicio condimento  
menage

Höhe	height
cm	in.
12,3	5

Cromargan®	versilbert
stainless 18/10	silverplated
<b>06.5171.6040</b>	<b>19.5171.6440</b>

Ersatzteil / spare part:  
Salzstreuer / salt shaker  
Pfefferstreuer / pepper shaker  
Ersatzglas / spare glass

06.6037.6040	19.6037.6440
06.6038.6040	19.6038.6440
	60.6037.9990



### Salz- und Pfeffergestell PURE

salt-pepper-set  
ménagère 2 pièces  
servicio condimento  
menage

Cromargan®, Kappen mattiert, Glas /  
stainless 18/10, tops satin finished, glass

Höhe	height
cm	in.
14,5	5 <sup>3</sup> / <sub>4</sub>

**06.5170.6040**

Ersatzteil / spare part:  
Salzstreuer / salt shaker  
Pfefferstreuer / pepper shaker  
Ersatzglas / spare glass

06.6062.6030
06.6063.6030
60.8253.9960



### Essig-/Ölgestell CLASSIC

oil and vinegar set  
huilier-vinaigrier  
vinagreras  
oliera

Höhe	height
cm	in.
23	9

Cromargan®	versilbert
stainless 18/10	silverplated
<b>06.1906.6040</b>	<b>19.1906.6440</b>

Ersatzteil / spare part:

Ersatzflasche / spare bottle

Höhe	height	Inhalt	cap.
cm	in.	Ltr.	oz.
19	7,5	0,15	5,22

19.9999.8632





**Essig-/Ölgestell  
PURE**

oil and vinegar set  
huilier-vinaigrier  
vinagreras  
oliera

Cromargan®, Kappen mattiert, Glas /  
stainless 18/10, tops satin finished, glass

Höhe	height
cm	in.
21	8 <sup>1</sup> / <sub>4</sub>

**06.1905.6040**

Ersatzteil / spare part:  
einzelne Flasche komplett / spare bottle complete  
Ersatzflasche / spare bottle  
Ausgießer / pouring stopper

06.6139.6030

60.8254.9960

60.8255.9990



**Essig-/Öl-Set  
URBAN**

oil and vinegar set  
huilier-vinaigrier  
vinagreras  
oliera

bestehend aus Tablett, Essig- und Ölflasche, Salz- und Pfefferstreuer. /  
consisting of tray, oil and vinegar bottle, salt and pepper shaker

Cromargan®, Glas / stainless 18/10, glass

Tablett / tray **55.0058.6045**

Essig-/Ölflasche / oil/vinegar bottle **55.0059.6040**

Salzstreuer / salt shaker **55.0062.6040**

Pfefferstreuer / pepper shaker **55.0063.6040**

Ersatzteil / spare part:  
Stopfen zu Streuer / stopper for shakers 55.0062.9502

Ausgießer zu Essig-/Ölflasche /  
pouirer for oil/vinegar bottle 55.0059.9802

Deckel zu Essig-/Ölflasche /  
lid for oil/vinegar bottle 55.0059.6803

\* Artikel einzeln bestellen / please order articles separately



**Tablett  
URBAN**

tray  
plateau  
bandeja  
vassoio

Cromargan® / stainless 18/10

Größe	size
cm	in.
23 x 10,7	8 x 4 <sup>1</sup> / <sub>4</sub>

**55.0058.6045**



### Essig-/Ölgestell, 3 tlg.

#### PURE

oil and vinegar set, 3 pcs.  
 huilier-vinaigrier, 3 parties  
 vinagreras, 3 piezas  
 oliera, a 3 vaschette

bestehend aus Gestell, Essig- und Ölflasche und Glasbehälter für Senf, Parmesan, Sambal Oelek u.a. /  
 consisting of: stand, oil / vinegar bottle and glass pots for mustard, parmesan, relish, etc.

Cromargan®, Glas / stainless 18/10, glass

Gestell hoch / stand high

Höhe	height	Ø	Ø	
cm	in.	cm	in.	
21	8 1/4	14	5 1/2	<b>06.2341.6045</b>

einzelne Flasche komplett / spare bottle complete

Höhe	height	Inhalt	cap.	
cm	in.	Ltr.	oz.	
16	6 1/2	0,2	6,96	<b>06.6139.6030</b>

Glas S (VPE 6 Stk.) / glass S (unit 6 pcs.)

Höhe	height	Inhalt	cap.	
cm	in.	Ltr.	oz.	
7,4	3	0,1	3,4	<b>60.2506.9990</b>

Ring S (VPE 6 Stk.) / ring S (unit 6 pcs.)

**06.2502.6040**

Deckel mit Ausschnitt / lid with cut-out

**55.0031.6040**

Espresso-/Mokkalöffel (VPE 12 Stk.) /  
 demi-tasse spoon (unit 12 pcs.)

**54.9901.6040**

\* Artikel einzeln bestellen / please order articles separately



### Essig-/Ölgestell, 4 tlg.

#### PURE

oil and vinegar set, 4 pcs.  
 huilier-vinaigrier, 4 parties  
 vinagreras, 4 piezas  
 oliera, a 4 vaschette

bestehend aus: Gestell, Essig- und Ölflasche, Salz- und Pfefferstreuer /  
 consisting of: stand, oil / vinegar bottle, salt / pepper shaker

Cromargan® / stainless 18/10

Höhe	height	Ø	Ø	
cm	in.	cm	in.	
21,1	8 1/2	14	5 1/2	<b>06.2341.6040</b>

Ersatzteil / spare part:

Gestell hoch / stand high

**06.2341.6045**

Höhe	height	Ø	Ø
cm	in.	cm	in.
21	8 1/4	14	5 1/2

Salzstreuer / salt shaker

**06.6062.6030**

Höhe	height	Ø	Ø
cm	in.	cm	in.
11	4 1/4	4,1	1 1/2

Pfefferstreuer / pepper shaker

**06.6063.6030**

Höhe	height	Ø	Ø
cm	in.	cm	in.
11	4 1/4	4,1	1 1/2

einzelne Flasche komplett / spare bottle complete

**06.6139.6030**

Höhe	height	Inhalt	cap.
cm	in.	Ltr.	oz.
16	6 1/2	0,2	6,96



**Essig-/Öl-Menage  
PURE EXCLUSIV**

oil and vinegar set  
huilier-vinaigrier  
vinagreras  
oliera

in 2 Holzvarianten. Mit 4 Einsätzen für Salz- und Pfefferstreuer, Essig- und Ölflasche von URBAN. Nicht spülmaschinengeeignet! /  
in 2 wood versions. With 4 inserts for salt shaker, pepper shaker, oil/ vinegar bottle of URBAN. Not dishwasher-safe!

Cromargan®, Holz dunkel gebeizt, Holz lackiert /  
stainless 18/10, wood dark stained, wood lacquered

**Menage groß dunkel / stand large dark**

Größe	size	
cm	in.	
14,5 x 14,5 x 25,4	5 <sup>3</sup> / <sub>4</sub> x 5 <sup>3</sup> / <sub>4</sub> x 10	<b>55.0034.6040</b>

**Menage groß natur / stand large nature**

Größe	size	
cm	in.	
14,5 x 14,5 x 25,4	5 <sup>3</sup> / <sub>4</sub> x 5 <sup>3</sup> / <sub>4</sub> x 10	<b>55.0034.6140</b>

**Essig-/Ölflasche / oil/vinegar bottle**

Höhe	height	Ø	Ø	Inhalt	cap.
cm	in.	cm	in.	Ltr.	oz.
15,2	6	5,7	2 <sup>1</sup> / <sub>4</sub>	0,15	5,07
					<b>55.0059.6040</b>

**Salzstreuer / salt shaker**

Höhe	height	Ø	Ø
cm	in.	cm	in.
8,5	3 <sup>1</sup> / <sub>4</sub>	4,5	1 <sup>3</sup> / <sub>4</sub>
			<b>55.0062.6040</b>

**Pfefferstreuer / pepper shaker**

Höhe	height	Ø	Ø
cm	in.	cm	in.
8,5	3 <sup>1</sup> / <sub>4</sub>	4,5	1 <sup>3</sup> / <sub>4</sub>
			<b>55.0063.6040</b>

\* Artikel einzeln bestellen / please order articles separately

## Essig-/Öl-Menage PURE EXCLUSIV

oil and vinegar set  
huilier-vinaigrier  
vinagreras  
oliera

in 2 Holzvarianten. Gestell mit 4 Einsätzen für Flaschen und Streuer.  
Nicht spülmaschinengeeignet! /  
in 2 wood versions. Stand with 4 inserts for bottles and shaker. Not  
dishwasher-safe!

Cromargan®, Holz dunkel gebeizt, Holz lackiert /  
stainless 18/10, wood dark stained, wood lacquered

Menage groß dunkel / stand large dark

Größe	size	
cm	in.	
14,5 x 14,5 x 25,4	5 <sup>3</sup> / <sub>4</sub> x 5 <sup>3</sup> / <sub>4</sub> x 10	55.0034.6040

Menage groß natur / stand large nature

Größe	size	
cm	in.	
14,5 x 14,5 x 25,4	5 <sup>3</sup> / <sub>4</sub> x 5 <sup>3</sup> / <sub>4</sub> x 10	55.0034.6140

einzelne Flasche komplett / spare bottle complete

Höhe	height	Inhalt	cap.
cm	in.	Ltr.	oz.
16	6 <sup>1</sup> / <sub>2</sub>	0,2	6,96

06.6139.6030

Salzstreuer / salt shaker

Höhe	height	Ø	Ø
cm	in.	cm	in.
11	4 <sup>1</sup> / <sub>4</sub>	4,1	1 <sup>1</sup> / <sub>2</sub>

06.6062.6030

Pfefferstreuer / pepper shaker

Höhe	height	Ø	Ø
cm	in.	cm	in.
11	4 <sup>1</sup> / <sub>4</sub>	4,1	1 <sup>1</sup> / <sub>2</sub>

06.6063.6030

\* Artikel einzeln bestellen / please order articles separately







**Essig-/Öl-Menage  
PURE EXCLUSIV**

oil and vinegar set  
huilier-vinaigrier  
vinagreras  
oliera

in 2 Holzvarianten. Mit 4 Einsätzen für kleine Essig-/Ölflasche PURE, große Essig-/Ölflasche PURE, Tassen S mit oder ohne Deckel von KAFFEEKULTUR und Mühle. Nicht spülmaschinengeeignet! / in 2 wood versions. With 4 inserts for small oil/vinegar bottle PURE, large oil/vinegar bottle PURE, cup S with or w/o lid of CoffeeCulture and mill. Not dishwasher-safe!

Cromargan®, Holz dunkel gebeizt, Holz lackiert / stainless 18/10, wood dark stained, wood lacquered

**Menage groß dunkel / stand large dark**

Größe	size	
cm	in.	
14,5 x 14,5 x 25,4	5 <sup>3</sup> / <sub>4</sub> x 5 <sup>3</sup> / <sub>4</sub> x 10	<b>55.0034.6040</b>

**Menage groß natur / stand large nature**

Größe	size	
cm	in.	
14,5 x 14,5 x 25,4	5 <sup>3</sup> / <sub>4</sub> x 5 <sup>3</sup> / <sub>4</sub> x 10	<b>55.0034.6140</b>

**Essig-/Ölflasche, klein / oil and vinegar bottle**

Höhe	height	Ø	Ø	
cm	in.	cm	in.	
13	5	4,1	1 <sup>1</sup> / <sub>2</sub>	<b>55.0098.6040</b>

**einzelne Flasche komplett / spare bottle complete**

Höhe	height	Inhalt	cap.	
cm	in.	Ltr.	oz.	
16	6 <sup>1</sup> / <sub>2</sub>	0,2	6,96	<b>06.6139.6030</b>

**Salzmühle / Pfeffermühle weiß / salt mill / pepper mill white**

Höhe	height	
cm	in.	
19	7 <sup>1</sup> / <sub>2</sub>	<b>06.6708.4500</b>

**Salzmühle / Pfeffermühle schwarz / salt mill / pepper mill black**

Höhe	height	
cm	in.	
19	7 <sup>1</sup> / <sub>2</sub>	<b>06.6709.4500</b>

**Porzellantasse S (VPE 6 Stk.) / porcelain cup S (unit 6 pcs.)**

Höhe	height	Inhalt	cap.	
cm	in.	Ltr.	oz.	
7,4	3	0,1	3,4	<b>60.2508.9990</b>

Deckel mit Ausschnitt / lid with cut-out **55.0031.6040**

Espresso-/Mokkalöffel (VPE 12 Stk.) / demi-tasse spoon (unit 12 pcs.) **54.9901.6040**

\* Artikel einzeln bestellen / please order articles separately

## Salz-/Pfeffer-Set PURE EXCLUSIV

salt and pepper set  
ménagère 3 pièces  
servicio condimento  
menage

in 2 Holzvarianten. Bestehend aus: Menage klein, Salz- und Pfefferstreuer, Glas S für Saucen, Butter, Senf... /  
in 2 wood versions. Consisting of: stand small, salt and pepper shaker, glass S for sauce, butter, mustard...

Cromargan®, Holz dunkel gebeizt, Holz lackiert /  
stainless 18/10, wood dark stained, wood lacquered

Menage klein dunkel / stand small dark

Größe	size
cm	in.
20,5 x 6,2 x 3,7	8 x 2 1/2 x 1 1/2

55.0039.6040

Menage klein natur / stand small nature

Größe	size
cm	in.
20,5 x 6,2 x 3,7	8 x 2 1/2 x 1 1/2

55.0039.6140

Salzstreuer / salt shaker

Höhe	height	Ø	Ø
cm	in.	cm	in.
11	4 1/4	4,1	1 1/2

06.6062.6030

Pfefferstreuer / pepper shaker

Höhe	height	Ø	Ø
cm	in.	cm	in.
11	4 1/4	4,1	1 1/2

06.6063.6030

Glas S (VPE 6 Stk.) / glass S (unit 6 pcs.)

Höhe	height	Inhalt	cap.
cm	in.	Ltr.	oz.
7,4	3	0,1	3,4

60.2506.9990

Deckel mit Ausschnitt / lid with cut-out

55.0031.6040

Espresso-/Mokkalöffel (VPE 12 Stk.) /  
demi-tasse spoon (unit 12 pcs.)

54.9901.6040

\* Artikel einzeln bestellen / please order articles separately





**Asia-Set  
PURE EXCLUSIV**

Asia set  
kit ASIA  
juego ASIA  
set ASIA

in 2 Holzvarianten. Bestehend aus: Menage klein, Essig- und Sojaflasche klein PURE, Glas S für Saucen, Butter, Senf... /

in 2 wood versions. Consisting of: menage small, vinegar and soy bottle small PURE, glass S for sauce, butter, mustard...

Cromargan®, Holz dunkel gebeizt, Holz lackiert / stainless 18/10, wood dark stained, wood lacquered

Menage klein dunkel / stand small dark

Größe	size	
cm	in.	
20,5 x 6,2 x 3,7	8 x 2 1/2 x 1 1/2	<b>55.0039.6040</b>

Menage klein natur / stand small nature

Größe	size	
cm	in.	
20,5 x 6,2 x 3,7	8 x 2 1/2 x 1 1/2	<b>55.0039.6140</b>

Essig-/Ölflasche, klein / oil and vinegar bottle

Höhe	height	Ø	Ø	
cm	in.	cm	in.	
13	5	4,1	1 1/2	<b>55.0098.6040</b>

Glas S (VPE 6 Stk.) / glass S (unit 6 pcs.)

Höhe	height	Inhalt	cap.	
cm	in.	Ltr.	oz.	
7,4	3	0,1	3,4	<b>60.2506.9990</b>

Deckel mit Ausschnitt / lid with cut-out **55.0031.6040**

Espresso-/Mokkalöffel (VPE 12 Stk.) / demi-tasse spoon (unit 12 pcs.) **54.9901.6040**

\* Artikel einzeln bestellen / please order articles separately



**Menage  
PURE EXCLUSIV**

menage  
menagère, à tapenades  
set 3 recipientes  
ménage per tapenade

in 2 Holzvarianten. Für Tapenade, Fleur de Sel oder Saucen und Dips / in 2 wood versions. For tapenade, fleur de sel or dips

Cromargan®, Holz dunkel gebeizt, Holz lackiert / stainless 18/10, wood dark stained, wood lacquered

Menage klein dunkel / stand small dark

Größe	size	
cm	in.	
20,5 x 6,2 x 3,7	8 x 2 1/2 x 1 1/2	<b>55.0039.6040</b>

Menage klein natur / stand small nature

Größe	size	
cm	in.	
20,5 x 6,2 x 3,7	8 x 2 1/2 x 1 1/2	<b>55.0039.6140</b>

Porzellanschälchen (VPE 6 Stk.) / porcelain bowl (unit 6 pcs.)

Höhe	height	Ø	Ø	Inhalt	cap.	
cm	in.	cm	in.	Ltr.	oz.	
4	1 1/2	5	2	0,04	1,4	<b>55.0093.9990</b>

Gewürzlöffel (VPE 12 Stk.) / spicy spoon (unit 12 pcs.)

Länge	length	
cm	in.	
7	2 3/4	<b>54.9184.6040</b>

\* Artikel einzeln bestellen / please order articles separately





**Senftopf  
CLASSIC**

mustard pot  
moutardier  
mostacero  
senapiera

Cromargan® / stainless 18/10

Höhe	height
cm	in.
9	3 1/2

06.6965.6040

Ersatzteil / spare part:  
Ersatzglas / spare glass

19.9999.8639



**Käsedose  
CLASSIC**

parmesan jar  
fromagère  
recipiente  
formaggiera

mit Kristalleinsatz /  
with crystal insert

Cromargan® / stainless 18/10

Ø	Ø
cm	in.
15,5	6

06.2885.6040

Ersatzteil / spare part:  
Ersatzglas / spare glass

19.9999.8637



**Käsedose  
NEUTRAL**

parmesan jar  
fromagère  
recipiente  
formaggiera

mit Kristalleinsatz /  
with crystal insert

Cromargan® / stainless 18/10

Ø	Ø
cm	in.
14,5	5 3/4

06.2868.6040

Ersatzteil / spare part:  
Ersatzglas / spare glass  
Deckel / cover  
Unterteller / underliner

60.8025.9990

06.2868.6042

06.1089.6043



# Buffet

buffet







**WMF Quadro. Buffet in Ihrem Takt.**  
Ein modulares Kombinations-Highlight.

**WMF Quadro. Buffet to your own beat.**  
A star of combination.



# WMF Quadro. Leuchtende Momente und individuelle Designs.

WMF Quadro. Bright moments and individual designs.



Der Schlüssel zur Individualität liegt insbesondere in der Verwendung des GN-Formats. Kein Buffet gleicht dem anderen. Alles im GN-Format. Für unbegrenzte Möglichkeiten, da alle Elemente gleich funktional sind. Dies eröffnet neue Freiheiten für Ihr System.

Das clevere Buffet-System kann durch Zugabe von Lichtelementen in kürzester Zeit das Ambiente verändern. In der Kunst werden Farben ganz gezielt eingesetzt, um bestimmte Stimmungen und Emotionen hervorzurufen. Diese Idee spiegelt sich in dem unverwechselbaren Look von WMF Quadro wieder. Die LED Lichter, als separater Bestandteil, können einfach und nach eigenem Geschmack in das Modul von WMF Quadro platziert werden. Diese unkomplizierte Handhabung macht das Buffet-System noch attraktiver.

The key to individuality lies especially in the use of the Gastronorm format. No buffet is the same as another. Everything in Gastronorm format. For unlimited options as all of the parts are just as functional. This allows a new freedom for your system.

To beautify the ambience within no time, the well-constructed buffet system can be achieved by light elements. In painting and art, colors are used specifically to evoke certain moods and emotions. This idea is applied to the unique look of the WMF Quadro system. As the lights can be used as separate components, they can be easily placed into the frame of the WMF Quadro system -suitable for your needs. This uncomplicated handling makes the buffet system even more attractive.

Die Einsätze. Aus weißem Porzellan.  
20 mm oder 65 mm Höhe. In Holz-  
optik, Rauchglas oder Glas satiniert.  
Brotkorbeinsatz 80 mm Höhe.

The inserts. Made of white porcelain.  
20 or 65 mm high. In a wood look,  
grey glass or satin glass.  
Bread basket insert 80 mm high.



Die Aufsätze und Konsolen.  
Optional. In verschiedenen Größen.  
The top frames and consoles.  
Optional. In various sizes.

Die Eiswanne.  
Optional. 55 mm oder 100 mm Höhe.  
The ice pan.  
Optional. 55 or 100 mm high.

Der Adapterrahmen. Aus Metall.  
Optional als LEDlight Einheit aus  
mattem Plexiglas.  
The adapter frame. Made of metal.  
Optionally as LEDlight unit made of  
matt acrylic glass.



Die Rahmen. Aus Edelstahl.  
80 mm oder 130 mm Höhe.  
The frames. Made of stainless  
steel. 80 or 130 mm high.



Ob Frühstücks-, Mittags-, Dessert- oder  
Abendbuffet: WMF Quadro macht den  
Aufbau besonders leicht. Einzelmodule  
und Kombinationen sind mit wenigen  
Handgriffen einsatzbereit und sofort  
reproduzierbar.

Whether a breakfast, midday, dessert or  
evening buffet, WMF Quadro makes it  
particularly easy to set up. It takes just  
a few touches to get single modules  
and combinations ready for use and this can  
immediately be reproduced.



mit LEDlight



ohne LEDlight

## Direkt zur eigenen Buffet-Bühne. Mit dem WMF Buffet Konfigurator.

Straight to your own buffet stage.  
With the WMF Buffet configurator.

WMF Quadro macht alles einfacher. Auch das Kennenlernen:  
Ihr WMF Partner hat den WMF Buffet Konfigurator mobil  
im Einsatz und bringt ihn zum Beratungsgespräch bei Ihnen  
vor Ort mit. Der Rest geht schnell: Ihre Tischgröße und Form  
definieren, 3D-Buffet-Elemente festlegen, nach Ihrem Wunsch  
kombinieren und ändern, exportieren – fertig.

WMF Quadro makes it all easier. Even getting to know it. Your  
WMF partner has a mobile version of the WMF buffet con-  
figurator and will bring it along to offer you advice on your  
premises. The rest is really quick. Define the size and shape of  
your tables, specify the 3D modules for your buffet, combine  
and change them as you wish, export – done.

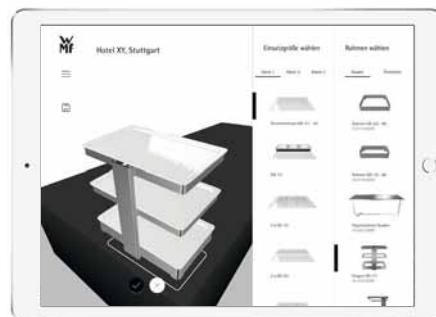



**Rahmen GN 1/1**

Frame GN 1/1

Cadre GN 1/1

Marco GN 1/1

Telaio GN 1/1

stapelbar, für GN Einsätze, nur in Verbindung mit Adapter 55.0164.6040 oder 55.0211.9900 /

stackable, for inserts GN, only in combination with adapter 55.0164.6040 or 55.0211.9900

Cromargan®, geschliffen / stainless 18/10, grinded

Maße	measures	Höhe	height	
cm	in.	cm	in.	
56,2 x 35,7	22 1/4 x 14 1/2	8	3 1/8	<b>55.0140.6090</b>
56,2 x 35,7	22 1/4 x 14 1/2	13	5 1/8	<b>55.0141.6090</b>

**Rahmen GN 2/3**

Frame GN 2/3

Cadre GN 2/3

Marco GN 2/3

Telaio GN 2/3

stapelbar, für GN Einsätze, nur in Verbindung mit Adapter 55.0165.6040 oder 55.0212.9900 /

stackable, for inserts GN, only in combination with adapter 55.0165.6040 or 55.0212.9900

Cromargan®, geschliffen / stainless 18/10, grinded

Maße	measures	Höhe	height	
cm	in.	cm	in.	
38,6 x 35,7	15 x 14 1/2	8	3 1/8	<b>55.0142.6090</b>
38,6 x 35,7	15 x 14 1/2	13	5 1/8	<b>55.0143.6090</b>

**Rahmen GN 2/4**

Frame GN 2/4

Cadre GN 2/4

Marco GN 2/4

Telaio GN 2/4

stapelbar, für GN Einsätze, nur in Verbindung mit Adapter 55.0166.6040 oder 55.0213.9900 /

stackable, for inserts GN, only in combination with adapter 55.0166.6040 or 55.0213.9900

Cromargan®, geschliffen / stainless 18/10, grinded

Maße	measures	Höhe	height	
cm	in.	cm	in.	
56,2 x 19	22 1/4 x 7	8	3 1/8	<b>55.0144.6090</b>
56,2 x 19	22 1/4 x 7	13	5 1/8	<b>55.0145.6090</b>

**Rahmen GN 1/3**

Frame GN 1/3

Cadre GN 1/3

Marco GN 1/3

Telaio GN 1/3

stapelbar, für GN Einsätze, nur in Verbindung mit Adapter 55.0167.6040 oder 55.0214.9900 /

stackable, for inserts GN, only in combination with adapter 55.0167.6040 or 55.0214.9900

Cromargan®, geschliffen / stainless 18/10, grinded

Maße	measures	Höhe	height	
cm	in.	cm	in.	
20,8 x 35,7	8 7/8 x 14 1/2	8	3 1/8	<b>55.0146.6090</b>
20,8 x 35,7	8 7/8 x 14 1/2	13	5 1/8	<b>55.0147.6090</b>



### Adapter GN 1/1

Adapter GN 1/1  
 Adaptateur GN 1/1  
 Adaptador GN 1/1  
 Adattatore GN 1/1

für Rahmen GN 1/1 55.0140.6090 und 55.0141.6090 /  
 for frame GN 1/1 55.0140.6090 and 55.0141.6090

Cromargan®, poliert / stainless 18/10, mirror finish

Maße	measures	Höhe	height
cm	in.	cm	in.
56,6 x 36,1	22 1/3 x 14 1/5	1	3/8

**55.0164.6040**



### Adapter GN 2/3

Adapter GN 2/3  
 Adaptateur GN 2/3  
 Adaptador GN 2/3  
 Adattatore GN 2/3

für Rahmen GN 2/3 55.0142.6090 und 55.0143.6090 /  
 for frame GN 2/3 55.0142.6090 and 55.0143.6090

Cromargan®, poliert / stainless 18/10, mirror finish

Maße	measures	Höhe	height
cm	in.	cm	in.
39 x 36,1	15 3/4 x 14 1/5	1	3/8

**55.0165.6040**



### Adapter GN 2/4

Adapter GN 2/4  
 Adaptateur GN 2/4  
 Adaptador GN 2/4  
 Adattatore GN 2/4

für Rahmen GN 2/4 55.0144.6090 und 55.0145.6090 /  
 for frame GN 2/4 55.0144.6090 and 55.0145.6090

Cromargan®, poliert / stainless 18/10, mirror finish

Maße	measures	Höhe	height
cm	in.	cm	in.
56,6 x 19,4	22 1/3 x 7 2/3	1	3/8

**55.0166.6040**



### Adapter GN 1/3

Adapter GN 1/3  
 Adaptateur GN 1/3  
 Adaptador GN 1/3  
 Adattatore GN 1/3

für Rahmen GN 1/3 55.0146.6090 und 55.0147.6090 /  
 for frame GN 1/3 55.0146.6090 and 55.0147.6090

Cromargan®, poliert / stainless 18/10, mirror finish

Maße	measures	Höhe	height
cm	in.	cm	in.
21 x 36,2	8 1/4 x 14 1/4	1	3/8

**55.0167.6040**



**Eiswanne GN 1/1**

Ice pan GN 1/1  
 Bac à glace GN 1/1  
 Coche hielo GN 1/1  
 Vasca ghiaccio GN 1/1

spülmaschinengeeignet /  
 dishwasher-safe

Kunststoff PMMA, transparent / plastic PMMA, transparent

Maße cm	measures in.	Höhe cm	height in.	
51,9 x 31,4	20 1/4 x 12 5/8	5,5	2 1/8	<b>55.0152.9900</b>
51,9 x 31,4	20 1/4 x 12 5/8	10	4	<b>55.0153.9900</b>



**Eiswanne GN 2/3**

Ice pan GN 2/3  
 Bac à glace GN 2/3  
 Coche hielo GN 2/3  
 Vasca ghiaccio GN 2/3

spülmaschinengeeignet /  
 dishwasher-safe

Kunststoff PMMA, transparent / plastic PMMA, transparent

Maße cm	measures in.	Höhe cm	height in.	
34,3 x 31,4	13 x 12 5/8	5,5	2 1/8	<b>55.0154.9900</b>
34,3 x 31,4	13 x 12 5/8	10	4	<b>55.0155.9900</b>



**Eiswanne GN 2/4**

Ice pan GN 2/4  
 Bac à glace GN 2/4  
 Coche hielo GN 2/4  
 Vasca ghiaccio GN 2/4

spülmaschinengeeignet /  
 dishwasher-safe

Kunststoff PMMA, transparent / plastic PMMA, transparent

Maße cm	measures in.	Höhe cm	height in.	
51,9 x 15,1	20 x 5 1/2	5,5	2 1/8	<b>55.0156.9900</b>
51,9 x 15,1	20 x 5 1/2	10	4	<b>55.0157.9900</b>



**Eiswanne GN 1/3**

Ice pan GN 1/3  
 Bac à glace GN 1/3  
 Coche hielo GN 1/3  
 Vasca ghiaccio GN 1/3

spülmaschinengeeignet /  
 dishwasher-safe

Kunststoff PMMA, transparent / plastic PMMA, transparent

Maße cm	measures in.	Höhe cm	height in.	
31,4 x 16,5	12 5/8 x 6	5,5	2 1/8	<b>55.0158.9900</b>
31,4 x 16,5	12 5/8 x 6	10	4	<b>55.0159.9900</b>



### Konsole GN $\frac{3}{6}$

console GN  $\frac{3}{6}$

Console GN  $\frac{3}{6}$

Consola GN  $\frac{3}{6}$

Mensola GN  $\frac{3}{6}$

stapelbar /

stackable

Cromargan®, geschliffen / stainless 18/10, grinded

Maße cm	measures in.	Höhe cm	height in.	
35 (17) x 32 (16)	14 (7) x 13 (6)	5,2	2	55.0170.6090



### Konsole GN $\frac{1}{6}$

console GN  $\frac{1}{6}$

Console GN  $\frac{1}{6}$

Consola GN  $\frac{1}{6}$

Mensola GN  $\frac{1}{6}$

stapelbar /

stackable

Cromargan®, geschliffen / stainless 18/10, grinded

Maße cm	measures in.	Höhe cm	height in.	
17,2 x 15,9	6 $\frac{3}{4}$ x 6 $\frac{1}{4}$	5,2	2	55.0171.6090



### Konsole GN $\frac{1}{6}$ mit Fuß

console GN  $\frac{1}{6}$  with feet

Console GN  $\frac{1}{6}$  avec pied

Consola GN  $\frac{1}{6}$  con pie

Mensola GN  $\frac{1}{6}$  con piede

stapelbar /

stackable

Cromargan®, geschliffen / stainless 18/10, grinded

Maße cm	measures in.	Höhe cm	height in.	
17,2 x 15,9	6 $\frac{3}{4}$ x 6 $\frac{1}{4}$	9,7	3 $\frac{7}{8}$	55.0173.6090



### Konsole GN $\frac{1}{3}$

console GN  $\frac{1}{3}$

Console GN  $\frac{1}{3}$

Consola GN  $\frac{1}{3}$

Mensola GN  $\frac{1}{3}$

stapelbar /

stackable

Cromargan®, geschliffen / stainless 18/10, grinded

Maße cm	measures in.	Höhe cm	height in.	
17,2 x 32,1	6 $\frac{3}{4}$ x 12 $\frac{5}{8}$	5,2	2	55.0172.6090





**Konsole GN 2/4**

console GN 2/4  
 Console GN 2/4  
 Consola GN 2/4  
 Mensola GN 2/4

stapelbar /  
 stackable

Cromargan®, geschliffen / stainless 18/10, grinded

Maße	measures	Höhe	height	
cm	in.	cm	in.	
52,5 x 15,6	20 5/8 x 6 1/8	5,2	2	<b>55.0174.6090</b>



**Brottschneidebrett GN 1/1**

Bread cutting board GN 1/1  
 Planche à pain GN 1/1  
 Tabla de cortar pan GN 1/1  
 Tagliere per pane GN 1/1

Holz Eiche / wood oak

Maße	measures	Höhe	height	
cm	in.	cm	in.	
53 x 32,5	21 x 13	1,9	3/4	<b>55.0198.9900</b>



**Platte GN 1/1**

Plate GN 1/1  
 Plaque GN 1/1  
 Plato GN 1/1  
 Piatto GN 1/1

	Maße	measures	Höhe	height	
	cm	in.	cm	in.	
Rauchglas einseitig mit Struktur / one-sided smoked glass with texture	53,0 x 32,5	21 x 13	0,5	1/4	<b>55.0175.9900</b>
Melamin > Holzoptik / melamine > wood finish	53,0 x 32,5	21 x 13	0,5	1/4	<b>55.0176.9900</b>
Glas transparent einseitig satiniert / glass transparent one-sided satinized	53,0 x 32,5	21 x 13	0,5	1/4	<b>55.0177.9900</b>



**Platte GN 2/3**

Plate GN 2/3  
 Plaque GN 2/3  
 Plato GN 2/3  
 Piatto GN 2/3

	Maße	measures	Höhe	height	
	cm	in.	cm	in.	
Rauchglas einseitig mit Struktur / one-sided smoked glass with texture	35,4 x 32,5	14 x 13	0,5	1/4	<b>55.0178.9900</b>
Melamin > Holzoptik / melamine > wood finish	35,4 x 32,5	14 x 13	0,5	1/4	<b>55.0179.9900</b>
Glas transparent einseitig satiniert / glass transparent one-sided satinized	35,4 x 32,5	14 x 13	0,5	1/4	<b>55.0180.9900</b>



### Platte GN $\frac{2}{4}$

Plate GN  $\frac{2}{4}$   
 Plaque GN  $\frac{2}{4}$   
 Plato GN  $\frac{2}{4}$   
 Piatto GN  $\frac{2}{4}$

	Maße cm	measures in.	Höhe cm	height in.	
Rauchglas einseitig mit Struktur / one-sided smoked glass with texture	53,0 x 16,2	21 x 6 $\frac{2}{3}$	0,5	$\frac{1}{4}$	<b>55.0181.9900</b>
Melamin > Holzoptik / melamine > wood finish	53,0 x 16,2	21 x 6 $\frac{2}{3}$	0,5	$\frac{1}{4}$	<b>55.0182.9900</b>
Glas transparent einseitig satiniert / glass transparent one-sided satinized	53,0 x 16,2	21 x 6 $\frac{2}{3}$	0,5	$\frac{1}{4}$	<b>55.0183.9900</b>



### Platte GN $\frac{1}{3}$

Plate GN  $\frac{1}{3}$   
 Plaque GN  $\frac{1}{3}$   
 Plato GN  $\frac{1}{3}$   
 Piatto GN  $\frac{1}{3}$

	Maße cm	measures in.	Höhe cm	height in.	
Rauchglas einseitig mit Struktur / one-sided smoked glass with texture	17,6 x 32,5	7 x 13	0,5	$\frac{1}{4}$	<b>55.0184.9900</b>
Melamin > Holzoptik / melamine > wood finish	17,6 x 32,5	7 x 13	0,5	$\frac{1}{4}$	<b>55.0185.9900</b>
Glas transparent einseitig satiniert / glass transparent one-sided satinized	17,6 x 32,5	7 x 13	0,5	$\frac{1}{4}$	<b>55.0186.9900</b>



### Platte GN $\frac{3}{6}$

Plate GN  $\frac{3}{6}$   
 Plaque GN  $\frac{3}{6}$   
 Plato GN  $\frac{3}{6}$   
 Piatto GN  $\frac{3}{6}$

	Maße cm	measures in.	Höhe cm	height in.	
Rauchglas einseitig mit Struktur / one-sided smoked glass with texture	35 (17) x 32 (16)	14 (7) x 13 (7)	0,5	$\frac{1}{4}$	<b>55.0193.9900</b>
Melamin > Holzoptik / melamine > wood finish	35 (17) x 32 (16)	14 (7) x 13 (7)	0,5	$\frac{1}{4}$	<b>55.0194.9900</b>
Glas transparent einseitig satiniert / glass transparent one-sided satinized	35 (17) x 32 (16)	14 (7) x 13 (7)	0,5	$\frac{1}{4}$	<b>55.0195.9900</b>

**Brotkorb GN 1/1**

Bread basket GN 1/1  
 Corbeille à pain GN 1/1  
 Panera GN 1/1  
 Cestino portapane GN 1/1

spülmaschinengeeignet /  
 dishwasher-safe

Kunststoffgeflecht PP / plastic meshwork PP

Maße	measures	Höhe	height	
cm	in.	cm	in.	
53 x 32,5	21 x 13	8	3 1/8	<b>55.0202.9900</b>

**Brotkorb GN 2/3**

Bread basket GN 2/3  
 Corbeille à pain GN 2/3  
 Panera GN 2/3  
 Cestino portapane GN 2/3

spülmaschinengeeignet /  
 dishwasher-safe

Kunststoffgeflecht PP / plastic meshwork PP

Maße	measures	Höhe	height	
cm	in.	cm	in.	
35,4 x 32,5	14 x 13	8	3 1/8	<b>55.0203.9900</b>

**Brotkorb GN 2/4**

Bread basket GN 2/4  
 Corbeille à pain GN 2/4  
 Panera GN 2/4  
 Cestino portapane GN 2/4

spülmaschinengeeignet /  
 dishwasher-safe

Kunststoffgeflecht PP / plastic meshwork PP

Maße	measures	Höhe	height	
cm	in.	cm	in.	
53 x 16,2	21 x 6 2/3	8	3 1/8	<b>55.0204.9900</b>

**Brotkorb GN 1/3**

Bread basket GN 1/3  
 Corbeille à pain GN 1/3  
 Panera GN 1/3  
 Cestino portapane GN 1/3

spülmaschinengeeignet /  
 dishwasher-safe

Kunststoffgeflecht PP / plastic meshwork PP

Maße	measures	Höhe	height	
cm	in.	cm	in.	
17,6 x 32,5	7 x 13	8	3 1/8	<b>55.0205.9900</b>



### Brotkorb GN 1/2

Bread basket GN 1/2  
Corbeille à pain GN 1/2  
Panera GN 1/2  
Cestino portapane GN 1/2

spülmaschinengeeignet /  
dishwasher-safe

Kunststoffgeflecht PP / plastic meshwork PP

Maße cm	measures in.	Höhe cm	height in.
26,5 x 32,5	7 x 13	8	3 1/8

55.0209.9900



### Aufsatz GN 1/2

top frame GN 1/2  
Corniche GN 1/2  
Suplemento GN 1/2  
Accessorio GN 1/2

auf/on GN 1/1, GN 2/3

Cromargan®, geschliffen / stainless 18/10, grinded

Maße cm	measures in.	Höhe cm	height in.
34,1 x 25	13 1/2 x 9 7/8	25	9 7/8

55.0206.6090



### Aufsatz GN 1/3

top frame GN 1/3  
Corniche GN 1/3  
Suplemento GN 1/3  
Accessorio GN 1/3

auf/on GN 1/1, GN 2/3, GN 1/3

Cromargan®, geschliffen / stainless 18/10, grinded

Maße cm	measures in.	Höhe cm	height in.
34,1 x 16,1	13 1/2 x 6 2/3	17	6 3/4

55.0207.6090



### Brücke GN 2/4

Bridge GN 2/4  
Pont GN 2/4  
Punte GN 2/4  
Ponte GN 2/4

für GN 2/4 Einsätze /  
for inserts GN 2/4

Cromargan®, geschliffen / stainless 18/10, grinded

Maße cm	measures in.	Höhe cm	height in.
64 x 20	25 x 8	30,8	12 1/8

55.0208.6090





**Etagere GN 1/1**

Serving stand GN 1/1  
 Etagère GN 1/1  
 Etageré GN 1/1  
 Alzata GN 1/1

für GN Einsätze, in Glas, Porzellan und Holzoptik /  
 for inserts GN, in glass, porcelain and wood optics

Cromargan®, geschliffen / stainless 18/10, grinded

Maße	measures	Höhe	height	
cm	in.	cm	in.	
51,7 x 36	20 1/2 x 14 1/4	50	19 3/4	<b>55.0210.6090</b>



**LEDlight Einheit**

LEDlight unit  
 Unitéampoule LED  
 LEDluz unidad  
 LEDlight Unità

mit Fernbedienung, Akku und Ladeeinheit, div. Lichtfarben einstellbar,  
 dimmbar /

with remote control, battery and charging unit, various light colors  
 adjustable, dimmable

Kunststoff transluzent / translucent plastic

Maße	measures	Höhe	height	
cm	in.	cm	in.	
Ø 9,3	Ø 3 5/8	2,6	1	<b>55.0230.9900</b>



**LEDlight Adapter GN 1/1**

LEDlight adapter GN 1/1  
 Adaptateurampoule LED GN 1/1  
 LEDluz Adaptador GN 1/1  
 LEDlight Adattatore GN 1/1

für Rahmen GN 55.0140.6090 und 55.0141.6090 /  
 for frame GN 55.0140.6090 and 55.0141.6090

Kunststoff transluzent / translucent plastic

Maße	measures	Höhe	height	
cm	in.	cm	in.	
56,5 x 36,1	22 1/4 x 14 1/4	1,5	5/8	<b>55.0211.9900</b>



**LEDlight Adapter GN 2/3**

LEDlight adapter GN 2/3  
 Adaptateurampoule LED GN 2/3  
 LEDluz Adaptador GN 2/3  
 LEDlight Adattatore GN 2/3

für Rahmen GN 55.0142.6090 und 55.0143.6090 /  
 for frame GN 55.0142.6090 and 55.0143.6090

Kunststoff transluzent / translucent plastic

Maße	measures	Höhe	height	
cm	in.	cm	in.	
39 x 36,1	15 1/3 x 14 1/4	1,5	5/8	<b>55.0212.9900</b>



### LEDlight Adapter GN $\frac{2}{4}$

LEDlight adapter GN  $\frac{2}{4}$   
 AdaptateurampouleLED GN  $\frac{2}{4}$   
 LEDluz Adaptador GN  $\frac{2}{4}$   
 LEDlight Adattatore GN  $\frac{2}{4}$

für Rahmen GN 55.0144.6090 und 55.0145.6090 /  
 for frame GN 55.0144.6090 and 55.0145.6090

Kunststoff transluzent / translucent plastic

Maße	measures	Höhe	height	
cm	in.	cm	in.	
56,5 x 19,6	22 $\frac{1}{4}$ x 7 $\frac{3}{4}$	1,5	$\frac{5}{8}$	<b>55.0213.9900</b>



### LEDlight Adapter GN $\frac{1}{3}$

LEDlight adapter GN  $\frac{1}{3}$   
 AdaptateurampouleLED GN  $\frac{1}{3}$   
 LEDluz Adaptador GN  $\frac{1}{3}$   
 LEDlight Adattatore GN  $\frac{1}{3}$

für Rahmen GN 55.0146.6090 und 55.0147.6090 /  
 for frame GN 55.0146.6090 and 55.0147.6090

Kunststoff transluzent / translucent plastic

Maße	measures	Höhe	height	
cm	in.	cm	in.	
21,2 x 36,1	8 $\frac{1}{4}$ x 14 $\frac{1}{4}$	1,5	$\frac{5}{8}$	<b>55.0214.9900</b>



### Porzellaneinsatz GN $\frac{3}{6}$

porcelain insert GN  $\frac{3}{6}$   
 Incrustation porcelaine GN  $\frac{3}{6}$   
 Interior de porcelana GN  $\frac{3}{6}$   
 Inserto porcellana GN  $\frac{3}{6}$

Größe	size	Inhalt	cap.	Höhe	height	
cm	in.	Ltr.	oz.	cm	in.	
35,4 / 17,4 x	14 (7) x	0,7	24,5	2	$\frac{3}{4}$	<b>55.0219.9800</b>
32,5 / 16,2	12 $\frac{3}{4}$ (6 $\frac{1}{3}$ )					
35,4 / 17,4 x	14 (7) x	2,5	87,5	6,5	2 $\frac{1}{2}$	<b>55.0220.9800</b>
32,5 / 16,2	12 $\frac{3}{4}$ (6 $\frac{1}{3}$ )					

Weitere Auswahl an Einsätzen auf Seite 228  
 More inserts available on page 228



### Porzellaneinsatz GN $\frac{1}{4}$

porcelain insert GN  $\frac{1}{4}$   
 Incrustation porcelaine GN  $\frac{1}{4}$   
 Interior de porcelana GN  $\frac{1}{4}$   
 Inserto porcellana GN  $\frac{1}{4}$

Größe	size	Inhalt	cap.	Höhe	height	
cm	in.	Ltr.	oz.	cm	in.	
26,5 x 16,2	10 $\frac{1}{2}$ x 6 $\frac{2}{3}$	1,2	40,6	6,5	2 $\frac{1}{2}$	<b>55.0226.9800</b>

Weitere Auswahl an Einsätzen auf Seite 228  
 More inserts available on page 228

**Porzellaneinsatz GN 1/6**

porcelain insert GN 1/6  
 Incrustation porcelaine GN 1/6  
 Interior de porcelana GN 1/6  
 Inserto porcellana GN 1/6

Größe cm	size in.	Inhalt Ltr.	cap. oz.	Höhe cm	height in.	
16,2 x 17,5	6 1/3 x 7	0,86	29,1	6,5	2 1/2	<b>55.0222.9800</b>



Weitere Auswahl an Einsätzen auf Seite 228  
 More inserts available on page 228

**Hygieneschutz**

hygienic cover  
 Protection hygiénique  
 Protección higiénica  
 Protezione igienica

Cromargan®, geschliffen, Kunststoff transparent /  
 stainless 18/10, grinded / transparent plastic

Maße cm	measures in.	Höhe cm	height in.	
115 x 30,4	45 1/4 x 12	52	20 1/2	<b>55.0227.6090</b>

**Beschriftunghalter hinten**

Label holder rear  
 Support pour inscription arrière  
 Soporte para etiqueta parte trasera  
 Supporto etichetta posteriore

Kunststoff transparent / transparent plastic

Maße cm	measures in.	Höhe cm	height in.	
8 x 4,6	3 1/8 x 1 7/8	1,9	3/4	<b>55.0229.9900</b>

**Beschriftunghalter vorne**

Label holder front  
 Support pour inscription avant  
 Soporte para etiqueta parte delantera  
 Supporto etichetta anteriore

Kunststoff transparent / transparent plastic

Maße cm	measures in.	Höhe cm	height in.	
8 x 4,8	3 1/8 x 1 3/4	1,4	1/2	<b>55.0228.9900</b>



# Der neue WMF Chafing Dish HOT & FRESH GN 1/1. Der große Buffet-Hotspot. Mit dem richtigen Durchblick.

The brand new WMF HOT & FRESH chafing dish GN 1/1.  
The big player on your buffet. With the good looks to show.



**NEU | NEW**

Der neue WMF HOT & FRESH GN 1/1 beweist Größe in seiner Kategorie. Er leistet sowohl mit Induktionsheizung als auch auf jeder anderen Standard-Wärmequelle tadellose Arbeit. Mit seinem transparenten Glasdeckel sieht er nicht nur gut aus. Er lässt auch die Speisen bestmöglich im Blick behalten. Hitzebeständige Griffe und gastronomietaugliche Materialien erleichtern die Arbeitsabläufe.

The new WMF HOT & FRESH GN 1/1 works perfectly with induction heating or with any other commonly used heat source. The lid is clear glass, so it doesn't just look good, it allows an excellent view of the food as well. Heat-resistant handles and catering-grade materials help keep workflows progressing smoothly.



Buffetgestell NEUTRAL  
buffet stand NEUTRAL



Buffetgestell MANHATTAN  
buffet stand MANHATTAN



Buffetgestell BASIC  
buffet stand BASIC



**Induktion und Intuition.**

Ein gekapselter Transtherm®-Boden mit Aluminiumkern, das intelligente Rücklaufsystem für Kondenswasser und ein umfangreiches Zubehör – WMF Chafing Dishes HOT & FRESH zeichnen sich durch ihre besondere Funktionalität und Flexibilität aus. Auf alle Produkte der WMF CHANGE Kollektion abgestimmt, lassen sie sich vielseitig kombinieren.

**Induction and intuition.**

An encapsulated Transtherm® base with aluminium core, the smart return system for condensation and an extensive choice of accessories – WMF HOT & FRESH chafing dishes are characterised by their superb functionality and versatility. Matched to all the products in the WMF CHANGE collection, they can be combined in lots of different ways.



**High End Design made in Germany.**

Hochwertige Bremsen sorgen dafür, dass der Lauf des Deckels optimal gedämpft wird. Er lässt sich spielend leicht öffnen, bleibt stufenlos stehen und ist ganz soft wieder verschließbar.

**High-end design made in Germany.**

High-quality brakes keep the movement of the lid optimally slow. The lid opens at a touch, stays open at any angle, and closes again softly to reseal perfectly.



**Immer in passender Form.**

Die WMF Chafing Dishes HOT & FRESH gibt es rund und rechteckig in GN 2/3- und GN 1/1-Größe, passend für Einsätze bis zehn Zentimeter Tiefe.

**Always in great shape.**

WMF HOT & FRESH chafing dishes are available round or rectangular in GN 2/3 and GN 1/1 size, compatible with inserts up to ten cm in depth.



**Produktvarianten**  
Product variants



rund  
round



GN 2/3  
GN 2/3



GN 1/1  
GN 1/1

**Ausführungen CHANGE**  
CHANGE models



HOT & FRESH „BASIC“



HOT & FRESH „MANHATTAN“



HOT & FRESH „PALAST“  
(Sonderausführung auf Anfrage.  
Special design on request.)

Abbildung Chafing Dishes HOT & FRESH „BASIC“ auf Buffetgestell NEUTRAL.  
Illustration HOT & FRESH 'BASIC' chafing dishes on NEUTRAL buffet stands.

**Chafing Dish, „Basic“, GN 1/1  
HOT & FRESH**

Chafing Dish, „Basic“, GN 1/1  
Chafing Dish, „Basic“, GN 1/1  
Chafing Dish, „Basic“, GN 1/1  
Chafing Dish, „Basic“, GN 1/1

passend für Einsätze bis Tiefe 10 cm, induktionsgeeignet, alternativ mit Heizplatte und Brennstoff beheizbar, Glasdeckel mit Bremse abnehmbar, Bügelgriff /  
for inserts up to depth 10 cm / 4 in., inductive, electrically and sterno heating possible, glass lid with break removable, bow handle

Cromargan®, Glas / stainless 18/10, glass

Größe	size
cm	in.
58 x 47 x 19	22 3/4 x 18 1/2 x 7 1/2

55.0128.6040



**Chafing Dish, „Manhattan“, GN 1/1  
HOT & FRESH**

Chafing Dish, „Manhattan“, GN 1/1  
Chafing Dish, „Manhattan“, GN 1/1  
Chafing Dish, „Manhattan“, GN 1/1  
Chafing Dish, „Manhattan“, GN 1/1

passend für Einsätze bis Tiefe 10 cm, induktionsgeeignet, alternativ mit Heizplatte und Brennstoff beheizbar, Glasdeckel mit Bremse abnehmbar, Griff 4-Kantprofil (matt) /  
for inserts up to depth 10 cm / 4 in., inductive, electrically and sterno heating possible, glass lid with break removable, bow handle, stainless steel polished, handle profile 4-cornered (satin finished)

Cromargan®, Glas / stainless 18/10, glass

Größe	size
cm	in.
58 x 47 x 19	22 3/4 x 18 1/2 x 7 1/2

55.0129.6040



**Chafing Dish, „Basic“, GN 2/3  
HOT & FRESH**

Chafing Dish, „Basic“, GN 2/3  
Chafing Dish, „Basic“, GN 2/3  
Chafing Dish, „Basic“, GN 2/3  
Chafing Dish, „Basic“, GN 2/3

passend für Einsätze bis Tiefe 10 cm, induktionsgeeignet, alternativ mit Heizplatte und Brennstoff beheizbar, Glasdeckel mit Bremse abnehmbar, Bügelgriff /  
fitting for inserts up to depth 10 cm / 4 in., inductive, electrically and sterno heating possible, glass lid with brake removable, bow handle

Cromargan®, Glas / stainless 18/10, glass

Größe	size
cm	in.
37 x 45 x 19	14 1/2 x 17 3/4 x 7 1/2

55.0002.6040





**Chafing Dish, „Manhattan“, GN 2/3  
HOT & FRESH**

Chafing Dish, „Manhattan“, GN 2/3  
Chafing Dish, „Manhattan“, GN 2/3  
Chafing Dish, „Manhattan“, GN 2/3  
Chafing Dish, „Manhattan“, GN 2/3

passend für Einsätze bis Tiefe 10 cm, induktionsgeeignet, alternativ mit Heizplatte und Brennstoff beheizbar, Glasdeckel mit Bremse abnehmbar, Griff 4-Kantprofil (mattiert) / fitting for inserts up to depth 10 cm / 4 in., inductive, electrically and sterno heating possible, glass lid with brake removable, handle profile 4-cornered (satin finished)

Cromargan®, Glas / stainless 18/10, glass

Größe	size
cm	in.
37 x 45 x 19	14 1/2 x 17 3/4 x 7 1/2

55.0021.6040



**Chafing Dish, „Basic“, rund  
HOT & FRESH**

Chafing Dish, „Basic“, round  
Chafing Dish, „Basic“, rond  
Chafing Dish, „Basic“, redondo  
Chafing Dish, „Basic“, rotondo

passend für Einsätze bis Tiefe 10 cm, induktionsgeeignet, alternativ mit Heizplatte und Brennstoff beheizbar, Glasdeckel mit Bremse abnehmbar, Bügelgriff / fitting for inserts up to depth 10 cm / 4 in., inductive, electrically and sterno heating possible, glass lid with brake removable, bow handle

Cromargan®, Glas / stainless 18/10, glass

Höhe	height	Ø	Ø
cm	in.	cm	in.
19	7 1/2	39	15 1/4

55.0001.6040



**Chafing Dish, „Manhattan“, rund  
HOT & FRESH**

Chafing Dish, „Manhattan“, round  
Chafing Dish, „Manhattan“, rond  
Chafing Dish, „Manhattan“, redondo  
Chafing Dish, „Manhattan“, rotondo

passend für Einsätze bis Tiefe 10 cm, induktionsgeeignet, alternativ mit Heizplatte und Brennstoff beheizbar, Glasdeckel mit Bremse abnehmbar, Griff 4-Kantprofil (mattiert) / fitting for inserts up to depth 10 cm / 4 in., inductive, electrically and sterno heating possible, glass lid with brake removable, handle profile 4-cornered (satin finished)

Cromargan®, Glas / stainless 18/10, glass

Höhe	height	Ø	Ø
cm	in.	cm	in.
19	7 1/2	39	15 1/4

55.0020.6040



**Buffetgestell, GN 1/1  
HOT & FRESH**

frame, GN 1/1  
bati, GN 1/1  
soporte buffet, GN 1/1  
telaio, GN 1/1

für Heizplatte und Brennstoff, passend zu allen Chafing Dishes GN 1/1  
HOT & FRESH /  
for electrically and sterno heating, fitting for all chafing dishes GN 1/1  
HOT & FRESH

Cromargan®, poliert / stainless 18/10, mirror finish

Größe	size
cm	in.
58 x 37 x 17	22 3/4 x 14 1/2 x 6 3/4

55.0137.6040

**Buffetgestell, „Basic“, GN 1/1  
HOT & FRESH**

frame, „Basic“, GN 1/1  
bati, „Basic“, GN 1/1  
soporte buffet, „Basic“, GN 1/1  
telaio, „Basic“, GN 1/1

für Heizplatte und Brennstoff, Füße Rundprofil /  
for electrically and sterno heating, feet profile round

Cromargan®, poliert / stainless 18/10, mirror finish

Größe	size
cm	in.
65 x 37 x 24	25 1/2 x 14 1/2 x 9 1/2

55.0130.6040



**Buffetgestell, „Manhattan“, GN 1/1  
HOT & FRESH**

frame, „Manhattan“, GN 1/1  
bati, „Manhattan“, GN 1/1  
soporte buffet, „Manhattan“, GN 1/1  
telaio, „Manhattan“, GN 1/1

für Heizplatte und Brennstoff, Füße 4-Kantprofil (mattiert) /  
for electrically and sterno heating, feet profile 4-cornered (satin  
finished)

Cromargan®, poliert / stainless 18/10, mirror finish

Größe	size
cm	in.
66 x 37 x 24	26 1/2 x 14 1/2 x 9 1/2

55.0131.6040







**Buffetgestell, GN 2/3**

**HOT & FRESH**

frame, GN 2/3  
 bati, GN 2/3  
 soporte buffet, GN 2/3  
 telaio, GN 2/3

für Heizplatte und Brennstoff, passend zu allen Chafing Dishes GN 2/3  
 HOT & FRESH /

for electrically and sterno heating, fitting for all chafing dishes GN 2/3  
 HOT & FRESH

Cromargan® / stainless 18/10

Größe	size
cm	in.
37 x 40 x 17	14 1/2 x 15 3/4 x 6 3/4

55.0006.6040



**Buffetgestell, „Basic“, GN 2/3**

**HOT & FRESH**

frame, „Basic“, GN 2/3  
 bati, „Basic“, GN 2/3  
 soporte buffet, „Basic“, GN 2/3  
 telaio, „Basic“, GN 2/3

für Heizplatte und Brennstoff, Füße Rundprofil /  
 for electrically and sterno heating, feet profile round

Cromargan® / stainless 18/10

Größe	size
cm	in.
44 x 40 x 24	17 1/4 x 15 3/4 x 9 1/2

55.0012.6040



**Buffetgestell, „Manhattan“, GN 2/3**

**HOT & FRESH**

frame, „Manhattan“, GN 2/3  
 bati, „Manhattan“, GN 2/3  
 soporte buffet, „Manhattan“, GN 2/3  
 telaio, „Manhattan“, GN 2/3

für Heizplatte und Brennstoff, Füße 4-Kantprofil (mattiert) /  
 for electrically and sterno heating, feet profile 4-cornered (satin  
 finished)

Cromargan® / stainless 18/10

Größe	size
cm	in.
44 x 40 x 24	17 1/4 x 15 3/4 x 9 1/2

55.0013.6040

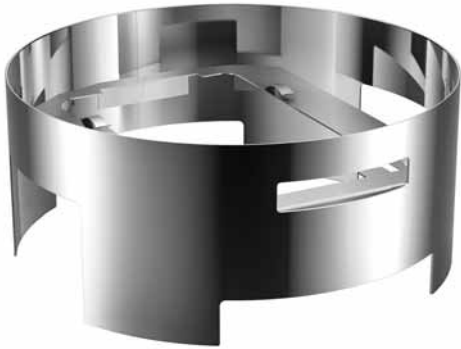

**Buffetgestell, rund  
HOT & FRESH**

frame, round  
bati, rond  
soporte buffet, redondo  
telaio, rotondo

für Heizplatte und Brennstoff, passend zu allen runden Chafing Dishes  
HOT & FRESH /  
for electrically and sterno heating, fitting for all round chafing dishes  
HOT & FRESH

Cromargan® / stainless 18/10

Höhe	height	Ø	Ø
cm	in.	cm	in.
17	6 <sup>3</sup> / <sub>4</sub>	39	15 <sup>1</sup> / <sub>4</sub>

55.0005.6040



**Buffetgestell, „Basic“, rund  
HOT & FRESH**

frame, „Basic“, round  
bati, „Basic“, rond  
soporte buffet, „Basic“, redondo  
telaio, „Basic“, rotondo

für Heizplatte und Brennstoff, Füße Rundprofil /  
for electrically and sterno heating, feet profile round

Cromargan® / stainless 18/10

Höhe	height	Ø	Ø
cm	in.	cm	in.
24	9 <sup>1</sup> / <sub>2</sub>	47	18 <sup>1</sup> / <sub>2</sub>

55.0007.6040



**Buffetgestell, „Manhattan“, rund  
HOT & FRESH**

frame, „Manhattan“, round  
bati, „Manhattan“, rond  
soporte buffet, „Manhattan“, redondo  
telaio, „Manhattan“, rotondo

für Heizplatte und Brennstoff, Füße 4-Kantprofil (mattiert) /  
for electrically and sterno heating, feet profile 4-cornered (satin  
finished)

Cromargan® / stainless 18/10

Höhe	height	Ø	Ø
cm	in.	cm	in.
24	9 <sup>1</sup> / <sub>2</sub>	47	18 <sup>1</sup> / <sub>2</sub>

55.0008.6040

---

## WMF CHANGE Chafing Dishes: Freie Hand am Buffet. Von allen Seiten.

WMF CHANGE chafing dishes:  
One hand free at the buffet. From all sides.

---



Die WMF CHANGE Chafing Dishes gehen Hand in Hand mit einem reibungslosen Ablauf am Buffet, denn sie sind besonders einfach bedienbar, hygienisch und ganzheitlich durchdacht. Ihre Rolltop-Deckel lassen sich nahezu geräuschlos und leicht auf und zu schieben, so dass immer eine Hand für den Teller und die Speisen frei bleibt. Nichts muss umständlich abgestellt oder wieder zugedeckt werden. Das spart Zeit, Energie und hebt die Laune.

The WMF CHANGE chafing dishes go hand in hand with smooth proceedings at the buffet due to being outstandingly user-friendly, hygienic and well-designed. The roll-top lids slide open and closed almost soundlessly and with the easy action that leaves one hand free for plate and goodies. Nothing has to be awkwardly set down or covered over again. This helps save time and energy and lifts the mood.

**Einfach und sorglos zu bedienen.**

Kein Tropfen, keine Wasserrückstände auf dem Tisch, dafür hitzeisolierte Griffe. Und die Deckel der WMF CHANGE Chafing Dishes mit integriertem Kondenswasserrücklauf sind komplett versenkbar. Sie schwingen außerhalb des Drehpunktes um den Brennstoffdosenhalter oder die Heizplatte vollständig unter den Behälter. So sind die Speisen von allen Seiten zugänglich und die Belüftung der Flamme ist stets gewährleistet.

**Handle without care.**

No drips, no water marking the table; thermally insulated handles instead. And the lids of the WMF CHANGE chafing dishes with integral condensation return are fully retractable. They swing outside the pivot point round the fuel-can holder or the hotplate and pass completely underneath the containers. So the dishes are accessible from all sides and the flame is never choked for air.

**Lässt sich mit Links öffnen.**

Ergonomisch durchdacht garantiert eine spezielle Kabelführung auch beim Einsatz eines elektrischen Heizteiles, dass sich der Deckel problemlos öffnen lässt. Leichtgängige, stufenlose Bremsen sorgen dafür, dass der Lauf des Deckels optimal gedämpft wird. Für ein spielend einfaches Öffnen, Schließen und Arretieren. Alle Modelle, außer Manhattan, lassen sich platz sparend stapeln.

**Opens at the lightest touch.**

A model of ergonomics in practice, a special cable guide allows the lid to open easily even when an electric heating element is in use. Smooth-acting, stepless brakes keep the movement of the lid optimally slow. For totally convenient opening, closing and stopping. All models, except the Manhattan, are stackable to save space.

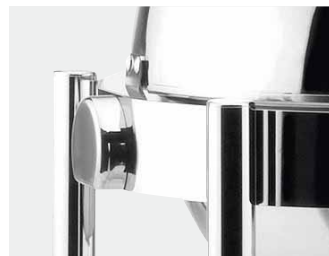
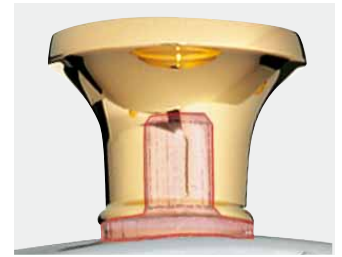

**Produktvarianten**  
Product variants



GN 1/1  
GN 1/1



rund  
round

**Ausführungen CHANGE**  
CHANGE models



„BASIC“



„MANHATTAN“



„METROPOLITAIN“





**Chafing Dish, "Basic"**

**CHANGE**

Chafing Dish, "Basic"  
 Chafing Dish, "Basic"  
 Chafing Dish, "Basic"  
 Chafing Dish, "Basic"

passend für Einsätze bis Tiefe 10 cm /  
 fitting for inserts up to depth 4 in.

GN 1/1, Rolltopdeckel, elektrisch und Brennstoff beheizbar, Deckel versenkbar /

GN 1/1, full rolltop cover, electrically and sterno heated, cover immersible

Cromargan®, Füße Rundprofil, Bügelgriffe /  
 stainless 18/10, feet profil round, with bow handles  
 ohne Einsätze / w/o inserts

Höhe cm	height in.	Größe mit Griffen cm	size with handles in.
45,6	18	74 x 38	28 1/4 x 15

**06.3333.6041**

Zubehör / accessory:

Heizelement/ heating element 230 V / 600 W 55.0097.6044

Heizelement/ heating element 120 V / 600 W 55.0097.9990

Heizelement mit Regler/

heating element adjustable 230 V / 700 W 06.3286.6046

Brennstoffdosenhalter / burner holder 06.3322.6039



**Chafing Dish, "Metropolitan"**

**CHANGE**

Chafing Dish, "Metropolitan"  
 Chafing Dish, "Metropolitan"  
 Chafing Dish, "Metropolitan"  
 Chafing Dish, "Metropolitan"

passend für Einsätze bis Tiefe 10 cm /  
 fitting for inserts up to depth 4 in.

GN 1/1, Rolltopdeckel, elektrisch und Brennstoff beheizbar, Deckel versenkbar /

GN 1/1, full rolltop cover, electrically and sterno heated, cover immersible

Cromargan®, Füße Rundprofil, Kugelgriffe /  
 stainless 18/10, feet profil round, with knob handles  
 ohne Einsätze / w/o inserts

Höhe cm	height in.	Größe mit Griffen cm	size with handles in.
45,6	18	74 x 38	28 1/4 x 15

**06.3330.6041**

Zubehör / accessory:

Heizelement/ heating element 230 V / 600 W 55.0097.6044

Heizelement/ heating element 120 V / 600 W 55.0097.9990

Heizelement mit Regler/

heating element adjustable 230 V / 700 W 06.3286.6046

Brennstoffdosenhalter / burner holder 06.3322.6039

Bitte Heizelement und Brennstoffdosenhalter separat bestellen. Einzelteile (Seite 231) /  
 Please order heating elements and burner holder separately. Spare parts (page 231)



### Chafing Dish, "Metropolitan", rund CHANGE

Chafing Dish, "Metropolitan", round  
Chafing Dish, "Metropolitan", rond  
Chafing Dish, "Metropolitan", redondo  
Chafing Dish, "Metropolitan", rotondo

passend für Einsätze bis Tiefe 10 cm /  
fitting for inserts up to depth 4 in.

rund, Rolltopdeckel, elektrisch und Brennstoff beheizbar, Deckel  
versenkbar /  
round, full rolltop cover, electrically and sterno heated, cover  
immersible

Cromargan®, Füße Rundprofil, Kugelgriff /  
stainless 18/10, feet profil round, with knob handle

Höhe	height	Ø	Ø
cm	in.	cm	in.
46	18	43	17

**06.3940.6041**

Zubehör / accessory:

Heizelement/ heating element 140-250 V / 270 W	55.0096.6044
Heizelement/ heating element 100-120 V / 230 W	55.0096.9990
Heizelement mit Regler/ heating element adjustable 230 V / 550 W	06.2095.6046
Brennstoffdosenhalter / burner holder	06.3940.6039



### Chafing Dish, "Manhattan" CHANGE

Chafing Dish, "Manhattan"  
Chafing Dish, "Manhattan"  
Chafing Dish, "Manhattan"  
Chafing Dish, "Manhattan"

passend für Einsätze bis Tiefe 10 cm /  
fitting for inserts up to depth 4 in.

GN 1/1, Rolltopdeckel, elektrisch und Brennstoff beheizbar, Deckel  
versenkbar /

GN 1/1, full rolltop cover, electrically and sterno heated, cover  
immersible

Cromargan®, teilmattiert, Füße und Griffe im 4-Kantprofil /  
stainless 18/10, partly satin finished, handles and feet profil 4-cornered  
ohne Einsätze / w/o inserts

Höhe	height	Größe mit Griffen	size with handles
cm	in.	cm	in.
45,6	18	74 x 38	28 1/4 x 15

**06.3335.6041**

Zubehör / accessory:

Heizelement/ heating element 230 V / 600 W	55.0097.6044
Heizelement/ heating element 120 V / 600 W	55.0097.9990
Heizelement mit Regler/ heating element adjustable 230 V / 700 W	06.3286.6046
Brennstoffdosenhalter / burner holder	06.3322.6039



**Chafing Dish, "Manhattan", rund  
CHANGE**

Chafing Dish, "Manhattan", round  
Chafing Dish, "Manhattan", rond  
Chafing Dish, "Manhattan", redondo  
Chafing Dish, "Manhattan", rotondo

passend für Einsätze bis Tiefe 10 cm /  
fitting for inserts up to depth 4 in.

rund, Rolltopdeckel, elektrisch und Brennstoff beheizbar, Deckel  
versenkbar /  
round, full rolltop cover, electrically and sterno heated, cover  
immersible

Cromargan®, teilmattiert, Füße und Griff im 4-Kantprofil /  
stainless 18/10, partly satin finished, handle and feet profil 4-cornered

Höhe	height	Ø	Ø	
cm	in.	cm	in.	
46	18	43	17	<b>06.3945.6041</b>

Zubehör / accessory:

Heizelement/ heating element 140-250 V / 270 W	55.0096.6044
Heizelement/ heating element 100-120 V / 230 W	55.0096.9990
Heizelement mit Regler/ heating element adjustable 230 V / 550 W	06.2095.6046
Brennstoffdosenhalter / burner holder	06.3940.6039



Breite Aufliegerahmen: 35,5 mm  
width supporting frame: 1 3/8 in.



**Chafing Dish „Metropolitan“, Thekeneinbau**

Chafing Dish, to be built into counter  
Chafing Dish, pour montage en comptoir  
Chafing Dish, encastrado  
Chafing Dish, emportable

passend für Einsätze bis Tiefe 10 cm /  
fitting for inserts up to depth 4 in.

GN 1/1, Rolltopdeckel, elektrisch beheizbar /  
GN 1/1, full rolltop cover, electrically heated

Cromargan® / stainless 18/10  
ohne Einsätze / w/o inserts

Höhe	height	Größe	size	
cm	in.	cm	in.	
17	6 3/4	65 x 47	25 5/8 x 18 1/2	<b>06.3266.6041</b>

Zubehör / accessory:

Heizelement/ heating element 230 V / 600 W	55.0097.6044
Heizelement/ heating element 120 V / 600 W	55.0097.9990
Heizelement mit Regler/ heating element adjustable 230 V / 700 W	06.3286.6046

Ausschnittmaße / cut out size

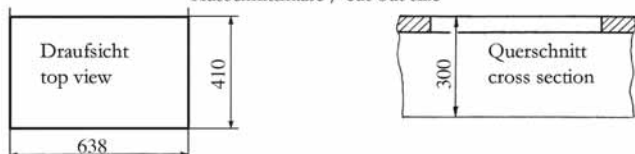

Bitte Heizelement und Brennstoffdosenhalter separat bestellen. Einzelteile (Seite 231) /  
Please order heating elements and burner holder separately. Spare parts (page 231)



### Portions-Chafing Dish „Metropolitan“

Chafing Dish, S  
Chafing Dish, S  
Chafing Dish, S  
Chafing Dish, S

passend für alle handelsüblichen Porzellanteller mit  $\varnothing$  23 cm, beheizbar mit Teelichte (nicht enthalten) / suitable for all porcelain plates  $\varnothing$  9 in., heated by tealights (not included)

rund, Rolltopdeckel, mit 2 Teelichten beheizbar / round, full rolltop cover, heated by 2 tealights

Cromargan® / stainless 18/10  
ohne Einsätze / w/o inserts

Höhe	height	$\varnothing$	$\varnothing$
cm	in.	cm	in.
29	11 $\frac{1}{2}$	26	10 $\frac{1}{4}$

06.3306.6040



Breite Aufliegerahmen: 40 mm  
width supporting frame: 1 $\frac{1}{2}$  in.



### Chafing Dish „Metropolitan“, Thekeneinbau

Chafing Dish, to be built into counter  
Chafing Dish, pour montage en comptoir  
Chafing Dish, encastrado  
Chafing Dish, emportable

passend für Einsätze bis Tiefe 10 cm / fitting for inserts up to depth 4 in.

rund, Rolltopdeckel, elektrisch beheizbar / round, full rolltop cover, electrically heated

Cromargan® / stainless 18/10  
ohne Hezelement, ohne Einsätze / w/o heating element, w/o inserts

Höhe	height	$\varnothing$	$\varnothing$
cm	in.	cm	in.
18,3	7 $\frac{1}{4}$	48	18 $\frac{7}{8}$

06.3290.6041

Zubehör / accessory:

Hezelement/ heating element 140-250 V / 270 W

55.0096.6044

Hezelement/ heating element 100-120 V / 230 W

55.0096.9990

Hezelement mit Regler/

heating element adjustable 230 V / 550 W

06.2095.6046

Draufsicht / top view

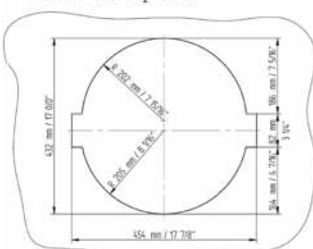

Ausschnittmaße / cut out size

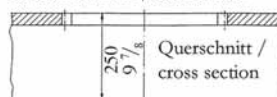





**Chafing Dish, mit Domdeckel**

**ECONOMY**

Chafing Dish, conventional standard cover  
 Chafing Dish, avec couvercle standard  
 Chafing Dish, tapa estándar  
 Chafing Dish, con coperchio standard

passend für Einsätze bis Tiefe 10 cm, Deckel zu allen 4 Seiten  
 hochstellbar /  
 fitting for inserts up to depth 4 in., lid can be raised on all 4 sides

GN 1/1, stapelbar, Domdeckel, elektrisch und Brennstoff beheizbar /  
 GN 1/1, stackable, conventional standard cover, electrically and sterno  
 heated

Cromargan® matt / stainless 18/10 satin finished  
 ohne Einsätze / w/o inserts

Höhe mit Griff	height with handle	Größe mit Griffen	size with handles	
cm	in.	cm	in.	
32	12 1/2	62 x 35	24 1/2 x 13 3/4	<b>06.3322.6230</b>

Zubehör / accessory:

Heizelement/ heating element 230 V / 600 W	55.0097.6044
Heizelement/ heating element 120 V / 600 W	55.0097.9990
Heizelement mit Regler/	
heating element adjustable 230 V / 700 W	06.3286.6046
Brennstoffdosenhalter / burner holder	06.3322.6039
Heizelement/ heating element 230 V / 1000 W	06.2082.6044
Adapter für Elektroheizteil /	
holder for heating element	06.3272.6039



**Chafing Dish, mit Klappdeckel**

**ECONOMY**

Chafing Dish, 1/2 rolltop cover  
 Chafing Dish, avec couvercle rabattable  
 Chafing Dish, con tapa abatible  
 Chafing Dish, con coperchio ribaltabile

passend für Einsätze bis Tiefe 10 cm /  
 fitting for inserts up to depth 4 in.

GN 1/1, Klappdeckel, elektrisch und Brennstoff beheizbar /  
 GN 1/1, cover, electrically and sterno heated

Cromargan® matt / stainless 18/10 satin finished  
 ohne Einsätze / w/o inserts

Höhe mit Griff	height with handle	Größe mit Griffen	size with handles	
cm	in.	cm	in.	
36	14 1/4	62 x 35	24 1/2 x 13 3/4	<b>06.3324.6230</b>

Zubehör / accessory:

Heizelement/ heating element 230 V / 600 W	55.0097.6044
Heizelement/ heating element 120 V / 600 W	55.0097.9990
Heizelement mit Regler/	
heating element adjustable 230 V / 700 W	06.3286.6046
Brennstoffdosenhalter / burner holder	06.3322.6039
Heizelement/ heating element 230 V / 1000 W	06.2082.6044
Adapter für Elektroheizteil /	
holder for heating element	06.3272.6039



Bitte Heizelement und Brennstoffdosenhalter separat bestellen. Einzelteile (Seite 231) /  
 Please order heating elements and burner holder separately. Spare parts (page 231)

Ersatzteile für WMF Chafing Dishes  
Spare parts for WMF Chafing Dishes

Bezeichnung Designation	Artikel-Nummer Order no.	Ausführung execution	Cromargan Stainless 18/10	Teilvergoldet partly gold plated	Deckel cover	Wasserbad- wanne water pan	Einbaurahmen frame	Brennstoffhalter burner holder	Heizelement heating element	Heizelement mit Regler heating element adjustable
Thekeneinbau GN 1/1	06.3266.6040	bis/ till 2015	•		06.3330.6042	06.3319.6231	06.3266.6045		55.0097.6044	06.3286.6046
Thekeneinbau GN 1/1	06.3266.6041	Neue Bremse/ New Brakes 2015	•		06.3330.6043		06.3266.6046			
Thekeneinbau, rund	06.3290.6040	bis/ till 2015	•		06.3283.6042	06.2003.6041	06.3290.6045		55.0096.6044	06.2095.6046
Thekeneinbau, rund	06.3290.6041	Neue Bremse/ New Brakes 2015	•		06.3940.6043		06.3290.6046			
Economy GN 1/1	06.3322.6230		•		06.3322.6232	06.3322.6231		06.3322.6039	55.0097.6044	06.3286.6046
Economy GN 1/1	06.3324.6230		•		06.3324.6232			06.3322.6039	55.0097.6044	06.3286.6046
Metropolitan GN 1/1	06.3330.6040	bis/ till 2015	•		06.3330.6042			06.3322.6039	55.0097.6044	06.3286.6046
Metropolitan GN 1/1	06.3330.6041	Neue Bremse/ New Brakes 2015	•		06.3330.6043					
Palast GN 1/1	06.3331.6210	bis/ till 2015		•	06.3331.6212 Auf Anfrage / on request					
Palast GN 1/1	Sonderausführung / special design Auf Anfrage / on request	Neue Bremse/ New Brakes 2015		•	Sonderausführung / special design Auf Anfrage / on request	06.3319.6231		06.3322.6039	55.0097.6044	06.3286.6046
Basic GN 1/1	06.3333.6040	bis/ till 2015	•		06.3333.6042			06.3322.6039	55.0097.6044	06.3286.6046
Basic GN 1/1	06.3333.6041	Neue Bremse/ New Brakes 2015	•		06.3333.6043					
Manhattan GN 1/1	06.3335.6040	bis/ till 2015	•		06.3335.6042				55.0097.6044	06.3286.6046
Manhattan GN 1/1	06.3335.6041	Neue Bremse/ New Brakes 2015	•		06.3335.6043			06.3322.6039	55.0097.6044	06.3286.6046
Metropolitan rund	06.3940.6040	bis/ till 2015	•		06.3940.6042			06.3940.6039	55.0096.6044	06.2095.6046
Metropolitan rund	06.3940.6041	Neue Bremse/ New Brakes 2015	•		06.3940.6043	06.2003.6041				
Palast rund	06.3941.6210	bis/ till 2015		•	06.3941.6212 Auf Anfrage / on request					
Palast rund	Sonderausführung / special design Auf Anfrage / on request	Neue Bremse/ New Brakes 2015		•	Sonderausführung / special design Auf Anfrage / on request	06.2003.6041		06.3940.6039	55.0096.6044	06.2095.6046
Manhattan rund	06.3945.6040	bis/ till 2015	•		06.3945.6042			06.3940.6039	55.0096.6044	06.2095.6046
Manhattan rund	06.3945.6041	Neue Bremse/ New Brakes 2015	•		06.3945.6043					
combiNation Buffet GN 1/1	06.2446.6040		•		06.2446.6042	06.3322.6231			55.0097.6044	06.3286.6046
combiNation Buffet GN 1/1	06.2423.6040		•			06.3322.6231			55.0097.6044	06.3286.6046
combiNation Buffet GN 1/1	06.2442.6040		•			06.3322.6231				

Bitte bestellen Sie die Heizelemente und Brennstoffhalter separat (s. Katalog Chafing Dish-Zubehör) Please order the heating elements and the burner holder separately. (see catalogue Chafing Dish-Accessory)



**Suppenmarmite**

soup tureen  
marmite à potage  
recipiente sopa  
zuppiera

passend in Chafing Dish GN 1/1 und HOT & FRESH GN 2/3 /  
fitting for chafing dish GN 1/1 and HOT & FRESH GN 2/3

Cromargan® / stainless 18/10

Größe	size	Inhalt	cap.
cm	in.	Ltr.	oz.
36 x 33	14 1/4 x 13	4,5	157,5

Topf f. Aufliegedeckel / pot f. normal lid	06.2007.6041
Aufliegedeckel / normal lid	06.2098.6042
Topf f. Scharnierdeckel / pot f. hinged lid	06.2007.9991
Scharnierdeckel / hinged lid	06.2007.9992
Einsatzring / ring	06.3301.6044

\* Artikel einzeln bestellen / please order articles separately



**Suppenmarmite**

soup tureen  
marmite à potage  
recipiente sopa  
zuppiera

passend in Chafing Dish GN 1/1 und HOT & FRESH GN 2/3 /  
fitting for chafing dish GN 1/1 and HOT & FRESH GN 2/3

Cromargan® / stainless 18/10

Größe	size	Inhalt	cap.
cm	in.	Ltr.	oz.
36 x 33	14 1/4 x 13	9	315

Topf mit Deckel / pot with cover	06.3297.6040
Einsatzring / ring	06.2094.6044

\* Artikel einzeln bestellen / please order articles separately



### Suppenstation, GN 1/1 mit Deckel

soup tureen, GN 1/1 with lid  
marmite à potage, GN 1/1 avec couvercle  
recipiente sopa, GN 1/1 con tapa  
zuppiera, GN 1/1 con coperchio

passend in Chafing Dish GN 1/1 /  
fitting for chafing dish GN 1/1

Größe	size	Inhalt	cap.
cm	in.	Ltr.	oz.
53 x 32,5	20 <sup>3</sup> / <sub>4</sub> x 12 <sup>3</sup> / <sub>4</sub>	2 x 4,5	2 x 157,5

#### Ausführung I /quality I

Cromargan® / stainless 18/10  
1 Abdeckplatte, 2 Suppentöpfe mit Scharnierdeckel / 1 insert  
plate and 2 soup tureens with hinged lid  
Komplett / complete

06.2007.9990

#### Ausführung II /quality II

Cromargan® / stainless 18/10  
1 Abdeckplatte und 2 Suppentöpfe mit Deckel / 1 insert plate  
and 2 soup tureens with lid  
Komplett / complete

06.2007.6040

Ersatzteil / spare part:

Topf f. Scharnierdeckel / pot f. hinged lid

06.2007.9991

Topf f. Aufliegedeckel / pot f. normal lid

06.2007.6041

Scharnierdeckel / hinged lid

06.2007.9992

Aufliegedeckel / normal lid

06.2098.6042

Brille / insert holder

06.2098.6044



### Suppenmarmite

soup tureen  
marmite à potage  
sopera para chafing dish  
zuppiera per chafing dish

passend in alle großen runden WMF Chafing Dishes und in den Chafing  
Dish HOT & FRESH rund. In 2 Versionen bestellbar: Ring + Topf f.  
Aufliegedeckel + Aufliegedeckel / Ring + Topf für Scharnierdeckel +  
Scharnierdeckel. /

fitting in all big round WMF chafing dishes and in Chafing Dish  
HOT & FRESH round. To be ordered in 2 versions: ring + pot f. normal lid +  
cover / ring + pot f. hinged lid + hinged cover.

Cromargan® / stainless 18/10

Inhalt	cap.	Ø	Ø
Ltr.	oz.	cm	in.
4,5	157,5	34	13 <sup>1</sup> / <sub>2</sub>

Ring / ring

55.0068.6040

Topf f. Aufliegedeckel / pot f. normal lid

06.2007.6041

Aufliegedeckel / normal lid

06.2098.6042

Topf f. Scharnierdeckel / pot f. hinged lid

06.2007.9991

Scharnierdeckel / hinged lid

06.2007.9992

\* Artikel einzeln bestellen / please order articles separately





**Suppenmarmite**

soup tureen  
marmite à potage  
sopera para chafing dish  
zuppiera per chafing dish

passend in alle großen runden Chafing Dishes von WMF und den Chafing Dish HOT & FRESH rund / fitting for all big round WMF chafing dishes and in chafing dish HOT & FRESH round

Cromargan® / stainless 18/10

Inhalt	cap.	Ø	Ø
Ltr.	oz.	cm	in.
9	315	34	13 1/2

Topf mit Deckel / pot with cover

06.3297.6040

Ring / ring

06.2087.6044

\* Artikel einzeln bestellen / please order articles separately



**Porzellan-Einsatz, geteilt**

porcelain insert, divided  
intérieur en porcelaine, divisé  
recipiente de porcelana, dividido  
interno in porcellana, ripartito

passend in alle großen runden Chafing Dishes von WMF / fitting for all big round WMF chafing dishes

Porzellan / porcelain

Höhe	height	Inhalt	cap.	Ø	Ø
cm	in.	Ltr.	oz.	cm	in.
7	2 3/4	2 x 1,75	2 x 62	33,5	13 1/4

60.3073.9990



**Porzellan-Einsatz**

porcelain insert  
intérieur en porcelaine  
interior porcelana  
interno in porcellana

passend in alle großen runden Chafing Dishes von WMF / fitting for all big round WMF chafing dishes

Porzellan / porcelain

Höhe	height	Inhalt	cap.	Ø	Ø
cm	in.	Ltr.	oz.	cm	in.
7	2 3/4	3,75	131,3	33,5	13 1/4

60.3072.9990



### Porzellan-Einsätze

porcelain insert  
intérieur en porcelaine  
interior de porcelana  
interno in porcellana

Porzellan weiß / porcelain white

Inhalt	cap.	Ø	Ø
Ltr.	oz.	cm	in.
1,5	52,5	20	8

60.3004.0690



### Einsatz für Chafing Dish

insert for chafing dish  
intérieur pour chafing dish  
depósito para chafing dish  
inserto piatto chafing dish

passend in alle großen runden Chafing Dishes von WMF /  
fitting for all big round WMF chafing dishes

Cromargan® / stainless 18/10

Höhe	height	Inhalt	cap.	Ø	Ø	
cm	in.	Ltr.	oz.	cm	in.	
8	3 1/4	5	175	33,4	13 1/4	06.2083.6034
10,5	4 1/4	6,5	227,5	33,4	13 1/4	06.2083.6033



### Platte, rund

platter, round  
plat, rond  
fuente, redonda  
vassoio, rotondo

passend in alle WMF Portions-Chafing Dishes /  
fitting for all WMF chafing dishes small size

Cromargan® / stainless 18/10

Ø	Ø
cm	in.
23	9

06.3306.6044





**Porzellan-Einsatz, zu Chafing Dish**

GN porcelain insert, for chafing dish  
 GN intérieur, pour chafing dish  
 GN interior porcelana, para chafing dish  
 GN interno in porcellana, per chafing dish

Beachten: Gastronorm-Einsätze passen **nicht** in die Eiswanne von combiNation buffet! /  
 GN inserts do **not** fit in the ice tray of combiNation buffet!

Porzellan / porcelain

Porzellaneinsatz GN <sup>3</sup>/<sub>6</sub> / porcelain insert GN <sup>3</sup>/<sub>6</sub>

Größe cm	size in.	Inhalt Ltr.	cap. oz.	Höhe cm	height in.	
35,4 / 17,4 x 32,5 / 16,2	14 (7) x 12 <sup>3</sup> / <sub>4</sub>	0,7	24,5	2	<sup>3</sup> / <sub>4</sub>	<b>55.0219.9800</b>
	(6 <sup>1</sup> / <sub>3</sub> )					
35,4 / 17,4 x 32,5 / 16,2	14 (7) x 12 <sup>3</sup> / <sub>4</sub>	2,5	87,5	6,5	2 <sup>1</sup> / <sub>2</sub>	<b>55.0220.9800</b>
	(6 <sup>1</sup> / <sub>3</sub> )					

Porzellaneinsatz GN <sup>1</sup>/<sub>6</sub> / porcelain insert GN <sup>1</sup>/<sub>6</sub>

Größe cm	size in.	Inhalt Ltr.	cap. oz.	Höhe cm	height in.	
16,2 x 17,5	6 <sup>1</sup> / <sub>3</sub> x 7	0,86	29,1	6,5	2 <sup>1</sup> / <sub>2</sub>	<b>55.0222.9800</b>

Porzellaneinsatz GN <sup>1</sup>/<sub>4</sub> / porcelain insert GN <sup>1</sup>/<sub>4</sub>

Größe cm	size in.	Inhalt Ltr.	cap. oz.	Höhe cm	height in.	
26,5 x 16,2	10 <sup>1</sup> / <sub>2</sub> x 6 <sup>2</sup> / <sub>3</sub>	1,2	40,6	6,5	2 <sup>1</sup> / <sub>2</sub>	<b>55.0226.9800</b>

Einsatz GN <sup>1</sup>/<sub>3</sub> / insert GN <sup>1</sup>/<sub>3</sub>

Größe cm	size in.	Inhalt Ltr.	cap. oz.	
2 x 17,5 x 32,5	<sup>3</sup> / <sub>4</sub> x 7 x 12 <sup>3</sup> / <sub>4</sub>	0,4	14	<b>60.3055.9990</b>
6,5 x 17,5 x 32,5	2 <sup>1</sup> / <sub>2</sub> x 7 x 12 <sup>3</sup> / <sub>4</sub>	1,9	64,2	<b>60.3047.9990</b>

Einsatz GN <sup>1</sup>/<sub>2</sub> / insert GN <sup>1</sup>/<sub>2</sub>

Größe cm	size in.	Inhalt Ltr.	cap. oz.	
2 x 26,5 x 32,5	<sup>3</sup> / <sub>4</sub> x 10 <sup>1</sup> / <sub>2</sub> x 12 <sup>3</sup> / <sub>4</sub>	0,7	24,5	<b>60.3054.9990</b>
6,5 x 26,5 x 32,5	2 <sup>1</sup> / <sub>2</sub> x 10 <sup>1</sup> / <sub>2</sub> x 12 <sup>3</sup> / <sub>4</sub>	3,3	111,54	<b>60.3045.9990</b>

Einsatz GN <sup>2</sup>/<sub>3</sub> / insert GN <sup>2</sup>/<sub>3</sub>

Größe cm	size in.	Inhalt Ltr.	cap. oz.	
2 x 35,4 x 32,5	<sup>3</sup> / <sub>4</sub> x 14 x 12 <sup>3</sup> / <sub>4</sub>	0,8	28	<b>60.3056.9990</b>
6,5 x 35,4 x 32,5	2 <sup>1</sup> / <sub>2</sub> x 14 x 12 <sup>3</sup> / <sub>4</sub>	4,65	157,17	<b>60.3046.9990</b>

Einsatz GN <sup>1</sup>/<sub>1</sub> / insert GN <sup>1</sup>/<sub>1</sub>

Größe cm	size in.	Inhalt Ltr.	cap. oz.	
2 x 53 x 32,5	<sup>3</sup> / <sub>4</sub> x 20 <sup>3</sup> / <sub>4</sub> x 12 <sup>3</sup> / <sub>4</sub>	1,4	49	<b>60.3053.9990</b>
6,5 x 53 x 32,5	2 <sup>1</sup> / <sub>2</sub> x 20 <sup>3</sup> / <sub>4</sub> x 12 <sup>3</sup> / <sub>4</sub>	7,3	246,74	<b>60.3044.9990</b>

Einsatz GN <sup>2</sup>/<sub>4</sub> / insert GN <sup>2</sup>/<sub>4</sub>

Größe cm	size in.	Inhalt Ltr.	cap. oz.	
2 x 16 x 53	<sup>3</sup> / <sub>4</sub> x 6 <sup>1</sup> / <sub>4</sub> x 20 <sup>3</sup> / <sub>4</sub>	0,7	24,5	<b>60.3057.9990</b>
6,5 x 16 x 53	2 <sup>1</sup> / <sub>2</sub> x 6 <sup>1</sup> / <sub>4</sub> x 20 <sup>3</sup> / <sub>4</sub>	2,5	87,5	<b>60.3048.9990</b>

### Gastronorm-Einsatz, zu Chafing Dish

GN insert, for chafing dish

GN intérieur, pour chafing dish

GN interior, para chafing dish

GN interno, per chafing dish

Beachten: Gastronorm-Einsätze passen **nicht** in die Eiswanne von combiNation buffet, sondern nur in mittlere und hohe Rahmen! / GN inserts do **not** fit in the ice tray of combiNation buffet, but only fit in frames medium and high!

Edelstahl 18/10 / stainless 18/10



Einsatz GN 1/3 / insert GN 1/3

Größe cm	size in.	Inhalt Ltr.	cap. oz.	
6,5 x 17,5 x 32,5	2 1/2 x 7 x 12 3/4	2,4	84	<b>19.9955.0577</b>
10 x 17,5 x 32,5	4 x 7 x 12 3/4	3,75	133	<b>19.9955.0578</b>

Einsatz GN 1/2 / insert GN 1/2

Größe cm	size in.	Inhalt Ltr.	cap. oz.	
6,5 x 26 x 32,5	2 1/2 x 10 1/4 x 12 3/4	3,8	133	<b>19.9955.0581</b>
10 x 26 x 32,5	4 x 10 1/4 x 12 3/4	6	210	<b>19.9955.0582</b>

Einsatz GN 2/3 / insert GN 2/3

Größe cm	size in.	Inhalt Ltr.	cap. oz.	
6,5 x 35,4 x 32,5	2 1/2 x 14 x 12 3/4	5,5	192,5	<b>19.9955.0585</b>
10 x 35,4 x 32,5	4 x 14 x 12 3/4	8,5	297,5	<b>19.9955.0586</b>



Einsatz GN 1/1 / insert GN 1/1

Größe cm	size in.	Inhalt Ltr.	cap. oz.	
6,5 x 53 x 32,5	2 1/2 x 20 3/4 x 12 3/4	8,5	297,5	<b>19.9955.0589</b>
10 x 53 x 32,5	4 x 20 3/4 x 12 3/4	13,3	465,5	<b>19.9955.0590</b>







**Heizelement**

heating element  
 plaque électrique  
 placa calentadora  
 piastra riscaldante

für WMF Chafing Dishes GN 1/1 ohne Rolltop-Deckel /  
 suitable for all WMF chafing dishes GN 1/1 without full rolltop cover

Größe	size
cm	in.
24 x 24	9 1/2 x 9 1/2

Heizelement/ heating element 230 V / 1000 W

06.2082.6044



**Adapter für Elektroheizteil**

holder for heating element  
 adaptateur pour plaque électrique  
 adaptador para placa calentadora  
 adattatore per piastra riscaldante

zum problemlosen Einsatz von Heizelement 06.2082.6044 und  
 06.2082.9990 für WMF Chafing Dishes GN 1/1 ohne Rolltop-Deckel /  
 suitable for easy use of heating element 06.2082.6044 and  
 06.2082.9990 for all WMF chafing dishes GN 1/1 without full rolltop  
 cover

Cromargan® / stainless 18/10

Größe	size	Höhe	height
cm	in.	cm	in.
25 x 20	9 3/4 x 7 3/4	7	2 3/4

06.3272.6039



**Heizelement**

heating element  
 plaque électrique  
 placa calentadora  
 piastra riscaldante

für alle großen runden WMF Chafing Dishes, VDE geprüft /  
 suitable for all big round WMF chafing dishes, VDE proved

Größe	size
cm	in.
20 x 20	7 3/4 x 7 3/4

Heizelement/ heating element 140-250 V / 270 W

55.0096.6044

Heizelement/ heating element 100-120 V / 230 W

55.0096.9990

Heizelement mit Regler/  
 heating element adjustable 230 V / 550 W

06.2095.6046



**Heizelement**

heating element  
 plaque électrique  
 place calentadora  
 piastra riscaldante

für WMF Chafing Dishes HOT & FRESH GN 2/3 und rund /  
 suitable for WMF chafing dishes HOT & FRESH GN 2/3 and round

Größe	size
cm	in.
25 x 20	9 3/4 x 7 3/4

Heizelement/ heating element 140-250 V / 220 W

55.0095.6044

Heizelement / heating element 120 V / 220 W

55.0135.9990

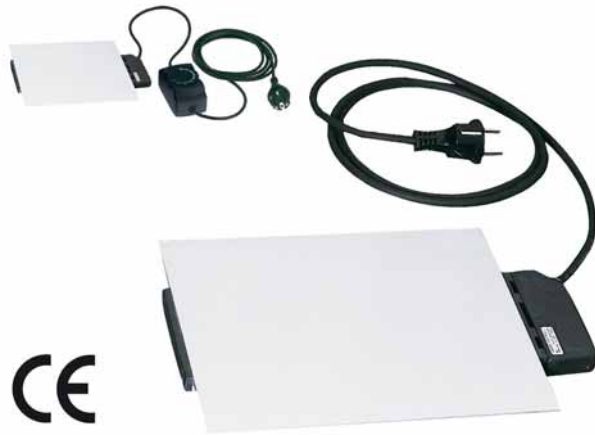

### Heizelement

heating element  
 plaque électrique  
 placa calentadora  
 piastra riscaldante

für WMF Chafing Dishes GN 1/1 und HOT & FRESH GN 1/1, VDE geprüft /  
 suitable for WMF chafing dishes GN 1/1 and HOT & FRESH GN 1/1, VDE proved

Größe	size
cm	in.
25 x 20	9 3/4 x 7 3/4

Heizelement/ heating element 230 V / 600 W	<b>55.0097.6044</b>
Heizelement/ heating element 120 V / 600 W	<b>55.0097.9990</b>
Heizelement mit Regler/ heating element adjustable 230 V / 700 W	<b>06.3286.6046</b>
Heizelement mit Regler/ heating element adjustable 120 V / 700 W	<b>55.0136.9990</b>



### Brennstoffdosenhalter

burner holder  
 porte brûleur  
 soporte quemador  
 fornello

zur problemlosen Umstellung von elektrischer Heizung auf Brennstoff.  
 Passend für alle WMF Chafing Dishes GN 1/1 und HOT & FRESH /  
 for uncomplicated conversion from electrical to burner heating. Fitting  
 for all WMF chafing dishes GN 1/1 and HOT & FRESH

Cromargan® / stainless 18/10

Größe	size
cm	in.
20 x 26 x 8,2	8 x 10 1/4 x 3 1/4

**06.3322.6039**



### Brennstoffdosenhalter

burner holder  
 porte brûleur  
 soporte quemador  
 fornello

zur problemlosen Umstellung von elektrischer Heizung auf Brennstoff.  
 Passend für alle runden Chafing Dishes CHANGE /  
 for uncomplicated conversion from electrical to burner heating. Fitting  
 for all round WMF chafing dishes CHANGE

Cromargan® / stainless 18/10

Größe	size	Höhe	height
cm	in.	cm	in.
12,5 x 20	5 x 8	8,5	3 1/4

**06.3940.6039**



### Brennstoffdose

fuel gel cartidge  
 boîtes de gel combustible  
 depósito de combustible  
 lattine di gel carburante

Großpackung 36 St. /  
 large package 36 pcs.

Inhalt	cap.
Ltr.	oz.
je Dose 0,2	each tin 7

**60.3002.0690**



**Besteckablage**

rack for utensils  
support couverts à servir  
soporte cubiertos servir  
porta posante

zum Einhängen in die Rahmen aller GN 1/1 Chafing Dishes CHANGE und HOT & FRESH, kann auch ohne Chafing Dish freistehend verwendet werden. /

to hinge in the frames of all GN 1/1 chafing dishes CHANGE and HOT & FRESH, can also be used on its own without Chafing Dish.

Cromargan®, Porzellan weiß / stainless 18/10, porcelain white

Tablett/Besteckhalter / tray/cutlery holder

Größe	size	
cm	in.	
27,9 x 12 x 7,1	11 x 4 <sup>3</sup> / <sub>4</sub> x 2 <sup>3</sup> / <sub>4</sub>	

06.3539.6040

Porzellanschale / porcelain bowl

Größe	size	
cm	in.	
21 x 8,7 x 3,25	8 <sup>1</sup> / <sub>4</sub> x 3 <sup>1</sup> / <sub>2</sub> x 1 <sup>1</sup> / <sub>4</sub>	

60.3540.9990

\* Artikel einzeln bestellen / please order articles separately

**Besteckablage**

rack for utensils  
support couverts à servir  
soporte cubiertos servir  
porta posante

passend in alle WMF Chafing Dishes GN 1/1 in Standard- und Economy-Ausführung / fitting for all WMF chafing dishes GN 1/1 design Standard and Economy

Cromargan® / stainless 18/10

Größe	size	
cm	in.	
30 x 9	12 x 3 <sup>1</sup> / <sub>2</sub>	

06.3296.6030



**Zwischensteg Induktion**

connecting shelf  
traverse  
pasarela  
ponticello

passend zu Chafing Dish HOT & FRESH / fitting with Chafing Dish HOT & FRESH

Cromargan® / stainless 18/10

55.0082.6040



## Chafing Dish – Besteck

chafing dish serving set  
 service pour chafing dish  
 cubiertos para chafing dish  
 posate chafing dish

Cromargan® / stainless 18/10

Chafing Dish Gabel / chafing dish fork

Länge	length
cm	in.
26	10 <sup>1</sup> / <sub>4</sub>

12.8386.6042



Chafing Dish Löffel / chafing dish spoon

Länge	length
cm	in.
26	10 <sup>1</sup> / <sub>4</sub>

12.8386.6041



Chafing Dish Gabel / chafing dish fork

Länge	length
cm	in.
26	10 <sup>1</sup> / <sub>4</sub>

12.8249.6040



Salatgabel / salad fork

Länge	length
cm	in.
26	10 <sup>1</sup> / <sub>4</sub>

12.8343.6042



Chafing Dish Gabel / chafing dish fork

Länge	length
cm	in.
32,5	12 <sup>3</sup> / <sub>4</sub>

12.8381.6042



Chafing Dish Löffel / chafing dish spoon

Länge	length
cm	in.
32,5	12 <sup>3</sup> / <sub>4</sub>

12.8381.6041



Fleischgabel / serving fork

Länge	length
cm	in.
32,5	12 <sup>3</sup> / <sub>4</sub>

12.8382.6040



Nudellöffel / pasta serving spoon

Länge	length
cm	in.
31,5	12 <sup>1</sup> / <sub>2</sub>

12.8383.6040



Chafing Dish Gabel / chafing dish fork

Länge	length
cm	in.
39	15 <sup>1</sup> / <sub>4</sub>

12.8387.6042



Chafing Dish Löffel / chafing dish spoon

Länge	length
cm	in.
39	15 <sup>1</sup> / <sub>4</sub>

12.8387.6041







**Coffee Urn, "Basic"**  
**CHANGE**

coffee urn, "Basic"  
coffee urn, "Basic"  
urna de café, "Basic"  
coffee urn, "Basic"

elektrisch und mit Brennstoff beheizbar. Heizelemente (110-250 V/ 150 W) und Brennstoffhalter bitte separat bestellen. / electrically and sterno heated. Please order heating elements (110-250 V/150W) separately.

Cromargan® / stainless 18/10

Höhe	height	Inhalt	cap.	Ø	Ø	
cm	in.	Ltr.	oz.	cm	in.	
54,5	21½	10	338	26	10¼	<b>06.1520.6040</b>
63,2	25	15	507	26	10¼	<b>06.1525.6040</b>

Zubehör / accessory:

Heizelement Coffee Urn / heating element 19.9999.9879

Brennstoffdose / fuel gel cartidge 60.3002.0690

Inhalt cap.  
Ltr. oz.  
je Dose 0,2 each tin 7

Brennstoffhalter Coffee Urn / burner holder coffee urn 06.1520.6039

Höhe	height	Ø	Ø
cm	in.	cm	in.
12,8	5	17	6¾



**Coffee Urn, "Manhattan"**  
**CHANGE**

coffee urn, "Manhattan"  
coffee urn, "Manhattan"  
urna de café, "Manhattan"  
coffee urn, "Manhattan"

elektrisch und mit Brennstoff beheizbar. Heizelemente (110-250 V/ 150 W) und Brennstoffhalter bitte separat bestellen. / electrically and sterno heated. Please order heating elements (110-250 V/150W) separately.

Cromargan® / stainless 18/10

Höhe	height	Inhalt	cap.	Ø	Ø	
cm	in.	Ltr.	oz.	cm	in.	
54,5	21½	10	338	26	10¼	<b>06.1524.6040</b>
63,2	25	15	507	26	10¼	<b>06.1529.6040</b>

Zubehör / accessory:

Heizelement Coffee Urn / heating element 19.9999.9879

Brennstoffdose / fuel gel cartidge 60.3002.0690

Inhalt cap.  
Ltr. oz.  
je Dose 0,2 each tin 7

Brennstoffhalter Coffee Urn / burner holder coffee urn 06.1520.6039

Höhe	height	Ø	Ø
cm	in.	cm	in.
12,8	5	17	6¾



### Brennstoffhalter Coffee Urn CHANGE

burner holder coffee urn  
porte brûleur coffee urns  
soporte quemador urna de café  
fornello coffee urn

passend zu Coffee Urns 10 und 15 l CHANGE /  
fitting for coffee urns 10 and 15 l CHANGE

Cromargan® / stainless 18/10

Höhe	height	Ø	Ø
cm	in.	cm	in.
12,8	5	17	6 <sup>3</sup> / <sub>4</sub>

06.1520.6039



### Heizelement Coffee Urn

heating element  
plaque électrique  
placa calentadora  
piastra riscaldante

passend zu Coffee Urns 10 und 15 l CHANGE, 140 - 250 V, 150 W,  
selbstregelnd /  
fitting for coffee urns 10 and 15 l CHANGE, 140 - 250 V, 150 W,  
self-regulating

19.9999.9879



### Schild mit Kette

name plate with chain  
étiquette avec chaîne  
etiqueta con cadena  
targhetta con aggancio a catenella

passend für Coffee Urns, individuelle Kennzeichnung möglich. Preis auf  
Anfrage. /

fitting on Coffee Urns, individual engraving possible. Please ask for  
respective costs.

Cromargan® / stainless 18/10

Länge	length
cm	in.
63	24 <sup>3</sup> / <sub>4</sub>

06.3151.6040

---

## WMF CHANGE Cerealien Dispenser: Dreh- und Angelpunkt. Für einen guten Morgen.

WMF CHANGE cereals dispensers:  
Where it's all at. For a good morning.

---

Zu einem erfrischenden Start in den Tag gehören eine abwechslungsreiche Ernährung und ein schöner Anblick. Für beides sorgt der WMF CHANGE Cerealien Dispenser als glänzender Energiespender auf dem Frühstücksbuffet. Seine ausgewogene Mischung aus Form und Funktion verbindet sich zu zwei Platz sparenden Produktvarianten.

A varied diet and good looks are important for a vigorous start to the day. Both are in place with a WMF CHANGE cereals dispenser as a glamorous energy-giving centrepiece on the breakfast buffet. Its balanced combination of form and function merges into two space-saving product variants.





### Spielend einfache Frische.

Die hygienischen Behälter sind leicht zu entnehmen, nachzufüllen und komplett spülmaschinengeeignet. Einfach am Bedienknopf drehen und die portionierte Entnahme der verschiedenen Müsli- und Getreideflocken regelt sich von selbst.

### Totally convenient freshness.

The hygienic containers are easy to remove and refill, as well as being completely dishwasher-safe. Simply turn the knob to dispense a measured helping of muesli or the cereal of your choice.

### Veredelte Frühschicht.

Das hochwertige Cromargan® der WMF CHANGE Cerealien Dispenser ist je nach Variante mattiert oder poliert. Die drehbare Variante lässt durch die platzsparende Anordnung der Cerealien-Röhren auch auf kleinem Raum keine Frühstückswünsche offen.

### Looking good at an early hour.

The high-quality Cromargan® of the WMF CHANGE cereals dispensers can be matte-finished or polished, depending on the version. If space is at a premium, the revolving version with the compact arrangement of the cereals cylinders leaves ample room for everything else that belongs on the breakfast table.

### Perfekte Harmonie.

Die Produkte der WMF Collection CHANGE sind variabel und stil-sicher. Egal ob Dispenser, Coffee Urns oder Chafing Dishes, alles passt zusammen und harmonisiert mit jeder Einrichtung.

### Perfect harmony.

The products in the WMF CHANGE collection are variable and stylistically flawless. Dispensers, coffee urns and chafing dishes: everything matches and harmonises with any interior fittings.

### Produktvarianten Product variants



Reihenlösung  
In-line solution



rund/drehbar (nur Modell „BASIC“)  
Round/revolving („BASIC“ model only)

### Ausführungen CHANGE CHANGE models



„BASIC“



„MANHATTAN“



„PALAST“

(Sonderausführung auf Anfrage.  
Special design on request.)







### Cerealiendispenser, drehbar „Basic“ CHANGE

cereal dispenser, rotatable, „Basic“  
dispenseur de céréales, rotatif, „Basic“  
dispensador de cereales, rotativo, „Basic“  
dispencer cereali, girabile, „Basic“

mit 3 Behältern, drehbar, portionierte und hygienische Entnahme durch Drehen, leicht zu befüllen, spülmaschinengeeignet, Durchmesser Behälter 11,3 cm; Inhalt jeweils 3,5 l; Unterstellhöhe 9,5 cm /  
with 3 containers, turnable, hygienic portioning by turning, easy to refill, dishwasher safe, dia. container 4<sup>1</sup>/<sub>2</sub> in.; cap. each container 118,3 oz.; clear height 3<sup>3</sup>/<sub>4</sub> in.

Gestell Cromargan®, Behälter PMMA farblos /  
stand stainless 18/10, container PMMA clear

Höhe	height	Ø	Ø
cm	in.	cm	in.
59,7	23 <sup>1</sup> / <sub>2</sub>	35,7	14

06.3530.6040

Ersatzteil / spare part:

Cerealienbehälter / container cereal dispenser

06.3530.6041



### Cerealiendispenser, Reihenlösung „Basic“ CHANGE

cereal dispenser, in-line „Basic“  
dispenseur de céréales, in-line „Basic“  
dispensador de cereales, in-line „Basic“  
dispencer cereali, in-line „Basic“

mit 3 Behältern, portionierte und hygienische Entnahme durch Drehen, leicht zu befüllen, spülmaschinengeeignet, Durchmesser Behälter 11,3 cm; Inhalt jeweils 3,5 l; Unterstellhöhe 9,5 cm /  
with 3 containers, hygienic portioning by turning, easy to refill, dishwasher safe, dia. container 4<sup>1</sup>/<sub>2</sub> in.; cap. each container 118,3 oz.; clear height 3<sup>3</sup>/<sub>4</sub> in.

Gestell Cromargan®, Behälter PMMA farblos /  
stand stainless 18/10, container PMMA clear

Größe	size
cm	in.
39 x 25 x 59,7	15 <sup>1</sup> / <sub>4</sub> x 9 <sup>3</sup> / <sub>4</sub> x 23 <sup>1</sup> / <sub>2</sub>

06.3640.6040

Ersatzteil / spare part:

Cerealienbehälter / container cereal dispenser

06.3530.6041



### Cerealiendispenser, Reihenlösung „Manhattan“ CHANGE

cereal dispenser, in-line „Manhattan“  
dispenseur de céréales, in-line „Manhattan“  
dispensador de cereales, in-line „Manhattan“  
dispencer cereali, in-line „Manhattan“

mit 3 Behältern, portionierte und hygienische Entnahme durch Drehen, leicht zu befüllen, spülmaschinengeeignet, Durchmesser Behälter 11,3 cm; Inhalt jeweils 3,5 l; Unterstellhöhe 9,5 cm /  
with 3 containers, hygienic portioning by turning, easy to refill, dishwasher safe, diam. container 4 1/2 in.; cap. each container 118,3 oz.; clear height 3 3/4 in.

Gestell Cromargan®, Behälter PMMA farblos /  
stand stainless 18/10, container PMMA clear

Größe	size
cm	in.
39 x 25 x 59,6	15 1/4 x 9 3/4 x 23 1/2

**06.3645.6040**

Ersatzteil / spare part:

Cerealienbehälter / container cereal dispenser

06.3530.6041

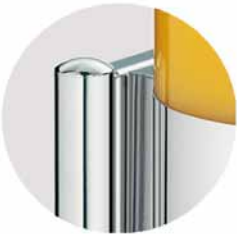

### Saftdispenser, „Basic“ CHANGE

juice dispenser, „Basic“  
dispenseur de jus, „Basic“  
dispensador de zumo, „Basic“  
dispenser per succhi di frutta, „Basic“

individuell höhenverstellbar, klare Kennzeichnung, tropffreier, hygienischer Auslauf, Kühlmöglichkeit durch Eisröhre (Zubehör). Attraktive Motive für die Frontseite zum Download unter [www.wmf-hotel.de](http://www.wmf-hotel.de) /

individually height adjustable, clear labelling, non dripping hygienic spout, cooling with ice tube (accessory). Attractive motifs for the frontside for download at [www.wmf-hotel.de](http://www.wmf-hotel.de)

Gestell Cromargan®, Behälter SAN-Kunststoff transparent /  
stand stainless 18/10, container SAN plastic clear

Mindesthöhe	min. height	Maximalhöhe	max. height	Größe	size
cm	in.	cm	in.	cm	in.
52	20 1/2	60	23 1/2	30,5 x 20	12 x 8

Inhalt mit Eisröhre	cap. incl. ice tube	Inhalt ohne Eisröhre	cap. w/o ice tube
Ltr.	oz.	Ltr.	oz.
5	175	6,5	227,5

**06.3130.6040**

Zubehör / accessory:

Eisröhre / ice tube

06.3130.6043

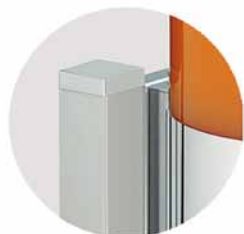

### Saftdispenser, "Manhattan" CHANGE

juice dispenser, "Manhattan"  
dispenseur de jus, "Manhattan"  
dispensador de zumo, "Manhattan"  
dispenser per succhi di frutta, "Manhattan"

individuell höhenverstellbar, klare Kennzeichnung, tropffreier, hygienischer Auslauf, Kühlmöglichkeit durch Eiströhre (Zubehör). Attraktive Motive für die Frontseite zum Download unter [www.wmf-hotel.de/](http://www.wmf-hotel.de/)

individually height adjustable, clear labelling, non dripping hygienic spout, cooling with ice tube (accessory). Attractive motifs for the frontside for download at [www.wmf-hotel.de](http://www.wmf-hotel.de)

Gestell Cromargan®, teilmattiert, Behälter SAN-Kunststoff transparent / stand stainless 18/10, partly satin finished, container SAN plastic clear

Mindesthöhe cm	min. height in.	Maximalhöhe cm	max. height in.	Größe cm	size in.
52	20½	60	23½	30,5 x 20	12 x 8

Inhalt mit Eiströhre Ltr.	cap. incl. ice tube oz.	Inhalt ohne Eiströhre Ltr.	cap. w/o ice tube oz.
5	175	6,5	227,5

**06.3135.6040**

Zubehör / accessory:

Eiströhre / ice tube 06.3130.6043



### Milchdispenser, "Basic" CHANGE

milk dispenser, "Basic"  
dispenseur de lait, "Basic"  
dispensador leche, "Basic"  
dispenser latte, "Basic"

individuell höhenverstellbar, klare Kennzeichnung, tropffreier, hygienischer Auslauf, Kühlmöglichkeit durch Eiströhre (Zubehör). Attraktive Motive für die Frontseite zum Download unter [www.wmf-hotel.de/](http://www.wmf-hotel.de/)

individually height adjustable, clear labelling, non dripping hygienic spout, cooling with ice tube (accessory). Attractive motifs for the frontside for download at [www.wmf-hotel.de](http://www.wmf-hotel.de)

Gestell Cromargan®, Behälter SAN-Kunststoff lichtundurchlässig / stand stainless 18/10, container SAN plastic opaque white

Mindesthöhe cm	min. height in.	Maximalhöhe cm	max. height in.	Größe cm	size in.
52	20½	60	23½	30,5 x 20	12 x 8

Inhalt mit Eiströhre Ltr.	cap. incl. ice tube oz.	Inhalt ohne Eiströhre Ltr.	cap. w/o ice tube oz.
5	175	6,5	227,5

**06.3390.6040**

Zubehör / accessory:

Eiströhre / ice tube 06.3130.6043



## Milchdispenser, "Manhattan" CHANGE

milk dispenser, "Manhattan"  
dispenseur de lait, "Manhattan"  
dispensador leche, "Manhattan"  
dispenser latte, "Manhattan"

individuell höhenverstellbar, klare Kennzeichnung, tropffreier, hygienischer Auslauf, Kühlmöglichkeit durch Eisröhre (Zubehör). Attraktive Motive für die Frontseite zum Download unter [www.wmf-hotel.de](http://www.wmf-hotel.de) /

individually height adjustable, clear labelling, non dripping, hygienic spout, cooling with ice tube (accessory). Attractive motifs for the frontside for download at [www.wmf-hotel.de](http://www.wmf-hotel.de)

Gestell Cromargan®, teilmattiert, Behälter SAN-Kunststoff  
lichtundurchlässig /

stand stainless 18/10, partly satin finished, container SAN plastic  
opaque white

Mindesthöhe cm	min. height in.	Maximalhöhe cm	max. height in.	Größe cm	size in.
52	20½	60	23½	30,5 x 20	12 x 8

Inhalt mit Eisröhre Ltr.	cap. incl. ice tube oz.	Inhalt ohne Eisröhre Ltr.	cap. w/o ice tube oz.
5	175	6,5	227,5

**06.3395.6040**

Zubehör / accessory:

Eisröhre / ice tube

06.3130.6043



## Eisröhre

ice tube  
tube à glace  
tubo para hielo  
tubo in acciaio

mit Crash Ice zu befüllen. Passend zu allen Saft- und Milchdispensern  
CHANGE /

to be filled up with crash-ice. Fitting for all juice and milk dispensers  
CHANGE

Cromargan® / stainless 18/10

Inhalt Ltr.	cap. oz.	Höhe cm	height in.	Ø cm	Ø upper in.
1	35	27	10¾	7,5	35

**06.3130.6043**



**Softbar, mit Gläserbord**

juice bar, with glass holder  
bar à jus de fruit, avec étagère pour verres  
set para zumos, con portavasos  
set girevole per succhi di frutta

bestehend aus: Gestell, 4 Kühlpellets /  
consisting of: stand, 4 cooling elements

drehbar /  
turnable

Cromargan®, Plexiglas / stainless 18/10, plexiglass

Höhe	height	Ø	Ø	
cm	in.	cm	in.	
47	18 <sup>1</sup> / <sub>2</sub>	47	18 <sup>1</sup> / <sub>2</sub>	<b>06.3232.6040</b>

Zubehör / accessory:

Glaskrug / glass pitcher 60.3061.9990

Inhalt	cap.
Ltr.	oz.
1,5	52,5

Ersatzteil / spare part:

Kühlpellet / cooling element 19.9999.5850

Ø	Ø
cm	in.
16	6 <sup>1</sup> / <sub>4</sub>

**Glaskrug**

glass pitcher  
broc en verre  
jarra de cristal  
brocca di vetro

2 Stück passen in die Eiswannen GN <sup>1</sup>/<sub>2</sub>, 4 St. in GN <sup>1</sup>/<sub>1</sub> /  
2 pcs. fitting in ice trays GN <sup>1</sup>/<sub>2</sub>, 4 St. in GN <sup>1</sup>/<sub>1</sub>

Glas / glass

Inhalt	cap.	Höhe	height	
Ltr.	oz.	cm	in.	
2	67	30	11 <sup>3</sup> / <sub>4</sub>	<b>09.4117.2000</b>



**Getränkekühler**

**DIVA**

beverage cooler  
 seau à boisson  
 cubo bebida  
 rinfresca bevanda

doppelwandig und stapelbar. Kann verwendet werden mit Kühlelement 55.0125.9990, für 3 Wasser-, Saft-, Milchkaraffen 06.1770.6040, 3 Getränkeflaschen (Bsp. Wasser, Wein, etc.) mit max. 10 cm Flaschendurchmesser, 6 Getränkeflaschen (Bsp. Wasser, Saft, Bier etc.) mit max. 7 cm Flaschendurchmesser /  
 double wall and stackable. Can be used with cooling element 55.0125.9990, for 3 water/juice/milk decanter 06.1770.6040, 3 beverage bottles (e.g. water, wine, etc.) with max. 4 in. bottle diameter, 6 beverage bottles (e.g. water, juice, beer, etc.) with max. 2 3/4 in. bottle diameter

Cromargan® / stainless 18/10

Größe	size	Inhalt	cap.	
cm	in.	Ltr.	oz.	
27,5 x 26,2 x 17	10 <sup>3</sup> / <sub>4</sub> x 10 <sup>1</sup> / <sub>4</sub> x 6 <sup>3</sup> / <sub>4</sub>	7,3	257	<b>55.0124.6040</b>



**Kühlelement**

**DIVA**

cooling element  
 élément réfrigérante  
 elemento refrigerador  
 elemento per il ghiaccio

mit Kühlgelfüllung zum Einfrieren. Stapelbar. Kann verwendet werden mit Getränkekühler 55.0124.6040 oder separat, für 3 Wasser-, Saft-, Milchkaraffen 06.1770.6040, 3 Getränkeflaschen (Bsp. Wasser, Wein, etc.) mit max. 10 cm Flaschendurchmesser, 6 Getränkeflaschen (Bsp. Wasser, Saft, Bier etc.) mit max. 7 cm Flaschendurchmesser /  
 with cooling core for freezing. Stackable. Can be used with beverage cooler 55.0124.6040 or separately, for 3 water decanter 06.1770.6040, 3 beverage bottles (e.g. water, wine, etc.) with max. 4 in. bottle diameter, 6 beverage bottles (e.g. water, juice, beer, etc.) with max. 2 3/4 in. bottle diameter

Kunststoff / plastic

Größe	size			
cm	in.			
25,3 x 24 x 13,3	10 x 9 <sup>1</sup> / <sub>2</sub> x 5 <sup>3</sup> / <sub>4</sub>			<b>55.0125.9990</b>



**Karaffe**

**BASIC**

decanter  
 carafe  
 garrafa

Deckel öffnet und schließt automatisch. /  
 Lid opens and closes automatically.

Glas, Cromargan®, Silikon / Glass, Cromargan®, silicone

Höhe	height	Inhalt	cap.	
cm	in.	Ltr.	oz.	
30	11 <sup>3</sup> / <sub>4</sub>	1	35	<b>06.1770.6040</b>

Ersatzteil / spare part:

Ersatzkaraffe / Replacement decanter **60.1770.9990**



**Cerealien-/Saft-Set**

set for cereal/juice dispenser  
 presentoir a cereales/jus de fruit  
 set para cereales/jugo  
 set per cereali/succhi

bestehend aus Gestell und 3 Schüttflöten mit Deckel, Inhalt je 2 Ltr., für Saft, Milch oder Cerealien /  
 consisting of base and 3 containers with lid, cap. 67,6 oz. each, for juice, milk or cereals

Cromargan®, SAN klar / Cromargan®, SAN clear

Größe	size
cm	in.
44,5 x 17,2 x 29,4	17 1/2 x 6 3/4 x 11 1/2

06.3648.6040

Ersatzteil / spare part:

Gestell, 3 Ausschnitte / base, for 3 inserts

06.3648.6045

Größe	size
cm	in.
44,5 x 17,2 x 3	17 1/2 x 6 3/4 x 1 1/4

Cerealien/Saft-Flöte / cereal/juice flute

06.8253.6040

Höhe	height	Inhalt	cap.	Ø	Ø
cm	in.	Ltr.	oz.	cm	in.
29,4	11 1/2	2	67,6	12,6	5

**Buffet-Set, Glas**

buffet set, glass  
 ensemble buffet, verre  
 juego de bufete, cristal  
 set per buffet, vetro

bestehend aus Gestell und 3 Gläsern (Inhalt je 0,7 Ltr.) inkl. Deckel mit Beschriftungsmöglichkeit. Beschriftungs-Beispiele zum Download auf [www.wmf-hotel.de](http://www.wmf-hotel.de) /

consisting of base with 3 glasses (cap. 23,66 oz. each) incl. lid. Motifs for labelling available for download on [www.wmf-hotel.de](http://www.wmf-hotel.de)

Cromargan®, Glas / stainless 18/10, glass

Größe	size
cm	in.
44,5 x 17,2 x 13	17 1/2 x 6 3/4 x 5

06.8242.6040

Ersatzteil / spare part:

Gestell, 3 Ausschnitte / base, for 3 inserts

06.3648.6045

Größe	size
cm	in.
44,5 x 17,2 x 3	17 1/2 x 6 3/4 x 1 1/4

Glasbehälter / glass bowl

60.8241.9990

Höhe	height	Inhalt	cap.	Ø	Ø
cm	in.	Ltr.	oz.	cm	in.
13	5	0,75	25,35	10,5	4 1/4

Deckel, mit Plexihülle / lid, with plexi cover  
 Plexihülle für Deckel / plastic holder for lid

06.8241.6042

60.8241.9996

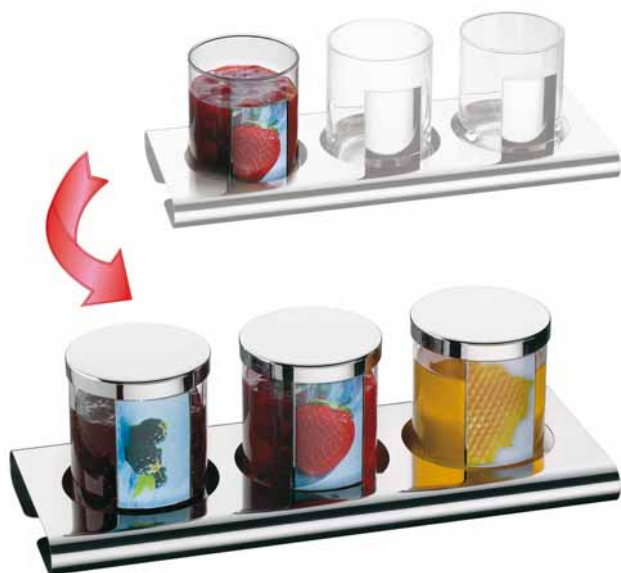



### Buffet-Set, Porzellan

buffet set, porcelain  
ensemble buffet, porcelaine  
juego de bufete, porcelana  
set per buffet, porcellana

bestehend aus Gestell und 3 Porzellanbehältern (Inhalt je 0,65 Ltr.)  
inkl. Deckel mit Beschriftungsmöglichkeit. Beschriftungs-Beispiele zum  
Download auf [www.wmf-hotel.de](http://www.wmf-hotel.de) /  
consisting of base with 3 porcelain bowls (cap. 21,97 oz. each) incl. lid.  
Motifs for labelling available for download on [www.wmf-hotel.de](http://www.wmf-hotel.de)

Cromargan®, Porzellan / stainless 18/10, porcelain

Größe	size	
cm	in.	
44,5 x 17,2 x 13	17 <sup>1</sup> / <sub>2</sub> x 6 <sup>3</sup> / <sub>4</sub> x 5	<b>06.8257.6040</b>

Ersatzteil / spare part:

Gestell, 3 Ausschnitte / base, for 3 inserts 06.3648.6045

Größe	size
cm	in.
44,5 x 17,2 x 3	17 <sup>1</sup> / <sub>2</sub> x 6 <sup>3</sup> / <sub>4</sub> x 1 <sup>1</sup> / <sub>4</sub>

Porzellanbehälter / porcelain bowl 60.8258.9990

Höhe	height	Inhalt	cap.	Ø	Ø
cm	in.	Ltr.	oz.	cm	in.
13	5	0,65	21,97	10,5	4 <sup>1</sup> / <sub>4</sub>

Deckel, mit Plexihülle / lid, with plexi cover 06.8241.6042

Plexihülle für Deckel / plastic holder for lid 60.8241.9996



### Teller-/Schalengestell

plate and bowl stand  
support pour bols à céréales  
soporte para platos o fuentes  
supporto per piatti e coppe

ohne Glasschalen /  
without glass bowls

Cromargan® / stainless 18/10

Höhe	height	Ø Ring	Ø ring
cm	in.	cm	in.
40,4	16	19,5	7 <sup>3</sup> / <sub>4</sub>

**06.4394.6040**

Zubehör / accessory:

Glasschale, 20 cm / glass bowl, 20 cm 19.9999.8642



### Dessertgestell

dessert stand  
présentoir à gâteau  
soporte plato postre  
porta piattini per dessert

ohne Gläser /  
w/o glasses

Cromargan® / stainless 18/10

Größe	size	
cm	in.	
40,6 x 7 x 4,9	16 x 2 <sup>3</sup> / <sub>4</sub> x 2	<b>06.8230.6040</b>

Zubehör / accessory:

Glas S (VPE 6 Stk.) / glass S (unit 6 pcs.) 60.2506.9990



**Dessertgestell  
PURE EXCLUSIV**

dessert stand  
présentoir à gâteau  
soporte plato postre  
porta piattini per dessert

in 2 Holzvarianten. Mit 3 Einsätzen für wahlweise Gläser S, Tassen S oder Sahnekännchen (o. Abb.) von KaffeeKultur und Tassen S von CultureCup (o. Abb.). Nicht spülmaschinengeeignet! (ohne Gläser) / in 2 wood versions. With 3 inserts alternatively for glasses S, cups S or creamer (w/o pic.) of CoffeeCulture and cups S CultureCup (w/o pic.). Not dishwasher-safe! (w/o glasses)

Cromargan®, Holz dunkel gebeizt, Holz lackiert / stainless 18/10, wood dark stained, wood lacquered

Menage klein dunkel / stand small dark

Größe	size	
cm	in.	
20,5 x 6,2 x 3,7	8 x 2 <sup>1</sup> / <sub>2</sub> x 1 <sup>1</sup> / <sub>2</sub>	<b>55.0039.6040</b>

Menage klein natur / stand small nature

Größe	size	
cm	in.	
20,5 x 6,2 x 3,7	8 x 2 <sup>1</sup> / <sub>2</sub> x 1 <sup>1</sup> / <sub>2</sub>	<b>55.0039.6140</b>

Glas S (VPE 6 Stk.) / glass S (unit 6 pcs.)

Höhe	height	Inhalt	cap.	
cm	in.	Ltr.	oz.	
7,4	3	0,1	3,4	<b>60.2506.9990</b>

\* Artikel einzeln bestellen / please order articles separately



**Dessertgestell  
PURE EXCLUSIV**

dessert stand  
présentoir à gâteau  
soporte plato postre  
porta piattini per dessert

in 2 Holzvarianten. Mit 3 Einsätzen für wahlweise Gläser S, Tassen S (o. Abb.) oder Sahnekännchen von KaffeeKultur und Tassen S von CultureCup (o. Abb.). Nicht spülmaschinengeeignet! / in 2 wood versions. With 3 inserts alternatively for glasses S, cups S (w/o pic.) or creamer of CoffeeCulture and cups S of CultureCup (w/o pic.). Not dishwasher-safe!

Cromargan®, Holz dunkel gebeizt, Holz lackiert / stainless 18/10, wood dark stained, wood lacquered

Menage klein dunkel / stand small dark

Größe	size	
cm	in.	
20,5 x 6,2 x 3,7	8 x 2 <sup>1</sup> / <sub>2</sub> x 1 <sup>1</sup> / <sub>2</sub>	<b>55.0039.6040</b>

Menage klein natur / stand small nature

Größe	size	
cm	in.	
20,5 x 6,2 x 3,7	8 x 2 <sup>1</sup> / <sub>2</sub> x 1 <sup>1</sup> / <sub>2</sub>	<b>55.0039.6140</b>

Sahnekännchen (VPE 6 Stk.) / creamer (unit 6 pcs.)

Höhe	height	Inhalt	cap.	
cm	in.	Ltr.	oz.	
7	2 <sup>3</sup> / <sub>4</sub>	0,1	3,4	<b>55.0033.9990</b>

Deckel mit Ausschnitt / lid with cut-out **55.0031.6040**

Espresso-/Mokkalöffel (VPE 12 Stk.) / demi-tasse spoon (unit 12 pcs.) **54.9901.6040**

\* Artikel einzeln bestellen / please order articles separately





### Dessertgestell

dessert stand  
présentoir à gâteau  
soporte platos postre  
porta piattini per dessert

passend für Teller bis Ø 16 cm (ohne Teller) /  
fitting for plates Ø 6<sup>1</sup>/<sub>4</sub> in. (without plates)

Cromargan® / stainless 18/10

Höhe	height	Ø	Ø	Ø Ring	Ø ring
cm	in.	cm	in.	cm	in.
25,5	10	18,5	7 <sup>1</sup> / <sub>4</sub>	10,5	4 <sup>1</sup> / <sub>4</sub>

06.4397.6040



### Serviergestell

serving stand  
présentoir à assiette  
soporte platos  
portapiatti

passend für Teller Ø 26 cm (ohne Teller) /  
fitting for plates Ø 10<sup>1</sup>/<sub>4</sub> in. (without plates)

Cromargan® / stainless 18/10

Höhe	height	Ø	Ø	Ø Ring	Ø ring
cm	in.	cm	in.	cm	in.
40	15 <sup>3</sup> / <sub>4</sub>	28,5	11 <sup>1</sup> / <sub>4</sub>	18,6	7 <sup>1</sup> / <sub>4</sub>

06.4395.6040

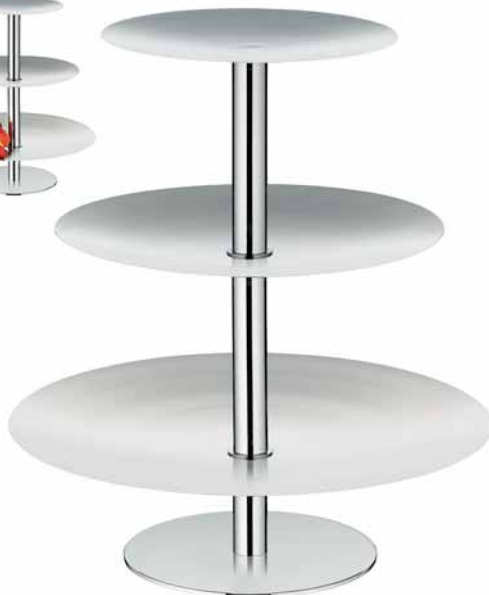

### Etagère, 3-teilig PURE

etagere, 3 parts  
étagère, en 3 parties  
frutero, de 3 pisos  
porta frutta, 3 piani

Cromargan® / stainless 18/10

Höhe	height	Ø Schale	Ø bowl
cm	in.	cm	in.
52,5	20 <sup>3</sup> / <sub>4</sub>	46 / 37 / 28	18 / 14 <sup>1</sup> / <sub>2</sub> / 11

06.0470.6040



**Mokkaétagère, 3-teilig**

**PURE**

pastry stand, 3 parts  
 porte petits fours, en 3 parties  
 portapastas, de 3 pisos  
 alzata portadolci, 3 piani

Cromargan® / stainless 18/10

Höhe cm	height in.	Ø Schale cm	Ø bowl in.
22,5	8 <sup>3</sup> / <sub>4</sub>	9 / 14 / 20	3 <sup>1</sup> / <sub>2</sub> / 5 <sup>1</sup> / <sub>2</sub> / 8

**06.6903.6040**



**Etagère, 3-teilig**

**BISTRO**

etagere, 3 parts  
 étagère, en 3 parties  
 frutero, de 3 pisos  
 porta frutta, 3 piani

Cromargan®, Glas / stainless 18/10, glass

Höhe cm	height in.	Ø Schale cm	Ø bowl in.
56	22	30 / 38 / 50	11 <sup>3</sup> / <sub>4</sub> / 15 / 19 <sup>3</sup> / <sub>4</sub>

**06.6893.6040**

Ersatzteil / spare part:

Glasschale klein / glass plate small	19.9999.8643
Glasschale mittel / glass plate medium	19.9999.8644
Glasschale groß / glass plate large	19.9999.8645



**Etagère**

etagere  
 étagère  
 frutero articulado  
 porta frutta

ohne Einsätze, Arme drehbar /  
 without inserts, insert holders turnable

rostfrei / stainless steel

Höhe cm	height in.	Ringe psc.
51	20	4tlg.

**06.3010.6040**



### Glasschale, 20 cm

glass bowl, 20 cm  
coupe verre glasskin, 20 cm  
depósitos de cristal, 20 cm  
interno in vetro, 20 cm

passend in Etagère / fitting in etagere 06.3010.6040, 06.3011.6040, 06.4394.6040

Höhe cm	height in.	Ø cm	Ø in.
8,5	3 <sup>1</sup> / <sub>4</sub>	20	8

19.9999.8642



### Tablett, rund

service tray, round  
plateau de service, rond  
bandeja, redonda  
vassoio, rotondo

passend in Etagère / fitting in etagere 06.3010.6040, 06.3011.6040

Cromargan® / stainless 18/10

Ø außen cm	outer Ø in.	Ø innen cm	Ø inside in.
29,5	11 <sup>1</sup> / <sub>2</sub>	24,5	9 <sup>3</sup> / <sub>4</sub>

06.3014.6041



### Kühlbehälter, mit Kühlpellet

cooler, with cooling element  
coupe réfrigérante, avec élément réfrigérante  
recipiente, con acumulador de frío  
base, con elemento refrigerante

passend in Etagère / fitting in etagere 06.3010.6040, 06.3011.6040, zum Kühlen von Tablett / to cool tray 06.3014.6041

Cromargan® / stainless 18/10

Ø cm	Ø in.
19	7 <sup>1</sup> / <sub>2</sub>

06.3014.6044

Ersatzteil / spare part:

Kühlpellet / cooling element

19.9999.5850



### Früchtekorb

fruit basket  
panier à fruits  
frutero  
fruttiera

passend in Etagère / fitting in etagere 06.3010.6040, 06.3011.6040, nur in Verbindung mit Kühlbehälter / only together with cooler 06.3014.6045 (bitte separat bestellen / please order separately)

Cromargan® / stainless 18/10

Höhe cm	height in.	Ø cm	Ø in.
22,5	8 <sup>3</sup> / <sub>4</sub>	26	10 <sup>1</sup> / <sub>4</sub>

06.6521.6040





**Plattenständer niedrig, GN 1/1**

tray stand low, GN 1/1  
 support pour plaques bas, GN 1/1  
 soporte platos bajo, GN 1/1  
 supporto piatto basso, GN 1/1

kombinierbar mit Servierplatten GN 1/1 06.2431.9990 (CORIAN), 06.7660.6040 (Edelstahl), 60.3053.9990 (Porzellan), 06.2432.9990 (Kunststoff), Kühlakku GN 1/2 und Abdeckhauben 06.2937.6040, 55.0134.6040 /  
 combinable with serving plates GN 1/1 06.2431.9990 (CORIAN), 06.7660.6040 (stainless steel 18/10), 60.3053.9990 (Porcelain), 06.2432.9990 (Plastic), cooling block GN 1/2 and covers 06.2937.6040, 55.0134.6040

stapelbar /  
 stackable

Cromargan® / stainless 18/10

Größe	size
cm	in.
51 x 30 x 12	20 x 11 <sup>3</sup> / <sub>4</sub> x 4 <sup>3</sup> / <sub>4</sub>

55.0132.6040



**Plattenständer hoch, GN 1/1**

tray stand high, GN 1/1  
 support pour plaques haut, GN 1/1  
 soporte platos alto, GN 1/1  
 supporto piatto alto, GN 1/1

kombinierbar mit Servierplatten GN 1/1 06.2431.9990 (CORIAN), 06.7660.6040 (Edelstahl), 60.3053.9990 (Porzellan), 06.2432.9990 (Kunststoff), Kühlakku GN 1/2 und Abdeckhauben 06.2937.6040, 55.0134.6040 /  
 combinable with serving plates GN 1/1 06.2431.9990 (CORIAN), 06.7660.6040 (stainless steel 18/10), 60.3053.9990 (Porcelain), 06.2432.9990 (Plastic), cooling block GN 1/2 and covers 06.2937.6040, 55.0134.6040

stapelbar /  
 stackable

Cromargan® / stainless 18/10

Größe	size
cm	in.
51 x 30 x 18	20 x 11 <sup>3</sup> / <sub>4</sub> x 7

55.0133.6040



**Kühlakku, GN 1/2**

cooling block, GN 1/2  
 brique réfrigérante, GN 1/2  
 acumulador refrigerador, GN 1/2  
 tavoletta per il ghiaccio, GN 1/2

2 Stück für Plattenständer GN 1/1 /  
 2 pcs. for trays stands GN 1/1

Kunststoff mit Kühlflüssigkeit / plastic with cooling liquid

Kühlakku, Gastronorm 1/2 /  
 cooling block, Gastronorm 1/2

Größe	size
cm	in.
25,5 x 20,3 x 3,2	10 x 8 x 1 <sup>1</sup> / <sub>4</sub>

60.3065.9990



### Platten, GN 1/1

platters, GN 1/1  
 planche pour recipient, GN 1/1  
 fuente, GN 1/1  
 piatto, GN 1/1

passend auf Plattenständer hoch und niedrig und alle GN 1/1 Rahmen /  
 fitting on tray stand high and low and all GN 1/1 frames



	Größe cm	size in.	Inhalt cap. Ltr. oz.	
CORIAN®	53 x 32,5	20 <sup>3</sup> / <sub>4</sub> x 12 <sup>3</sup> / <sub>4</sub>		<b>06.2431.9990</b>
Cromargan® GN 1/1 / stainless 18/10	53 x 32,5	20 <sup>3</sup> / <sub>4</sub> x 12 <sup>3</sup> / <sub>4</sub>		<b>06.7660.6040*</b>
Porzellan / porcelain	2 x 53 x 32,5	3/4 x 20 <sup>3</sup> / <sub>4</sub> x 12 <sup>3</sup> / <sub>4</sub>	1,4 49	<b>60.3053.9990</b>
Kunststoff / plastic	53 x 32,5	20 <sup>3</sup> / <sub>4</sub> x 12 <sup>3</sup> / <sub>4</sub>		<b>06.2432.9990</b>

\* Passend auf alle GN 1/1 Rahmen und auf Plattenständer niedrig/hoch /  
 fitting on all GN 1/1 frames and on tray stands low/high

### Abdeckhaube

cover for trays  
 cloche pour plateaux  
 campana para bandejas  
 coperchio adatto per vassoio

mit 2 seitlichen Eingriffen, passend für Tablett GN 1/1 ohne Griffe und  
 Plattenständer niedrig/hoch /  
 with two side openings, fitting for trays GN 1/1 without handles and on  
 tray stands low/high

Kunststoff glasklar, Griff verchromt /  
 high quality plastic, handle chrome plated

Größe cm	size in.
55,5 x 35 x 14,5	21 <sup>3</sup> / <sub>4</sub> x 13 <sup>3</sup> / <sub>4</sub> x 5 <sup>3</sup> / <sub>4</sub>

**06.2937.6040**



### Abdeckhaube

cover for trays  
 cloche pour plateaux  
 campana para bandejas  
 coperchio adatto per vassoio

halbrollend, passend für Platten GN 1/1 ohne Griffe und Plattenständer  
 niedrig/hoch /  
 half rolling, fitting for plates GN 1/1 without handles and tray stands  
 low/high

Kunststoff glasklar, Griff verchromt /  
 high quality plastic, handle chrome plated

Größe cm	size in.
53 x 32,5 x 17	20 <sup>3</sup> / <sub>4</sub> x 12 <sup>3</sup> / <sub>4</sub> x 6 <sup>3</sup> / <sub>4</sub>

**55.0134.9990**





**Tablett, rund  
CLASSIC**

serving tray, round  
plateau de service, rond  
bandeja, redonda  
vassoio, rotondo

Ø	Ø
cm	in.
29,5	11 <sup>1</sup> / <sub>2</sub>
35	13 <sup>3</sup> / <sub>4</sub>
41,7	16 <sup>1</sup> / <sub>2</sub>

Cromargan®	versilbert
stainless 18/10	silverplated
<b>06.7260.6040</b>	<b>19.7260.6440</b>
<b>06.7261.6040</b>	<b>19.7261.6440</b>
<b>06.7262.6040</b>	<b>19.7262.6440</b>



**Tablett, rund  
BISTRO**

serving tray, round  
plateau de service, rond  
bandeja, redonda  
vassoio, rotondo

stapelbar /  
stackable

Cromargan® / stainless 18/10

Ø	Ø
cm	in.
42,6	16 <sup>3</sup> / <sub>4</sub>

**06.7679.6040**



**Tablett, oval**

serving tray, oval  
plateau de service, ovale  
bandeja, oval  
vassoio, ovale

Cromargan® / stainless 18/10

Größe	size
cm	in.
51,6 x 39,3	20 <sup>1</sup> / <sub>4</sub> x 15 <sup>1</sup> / <sub>2</sub>

**06.7265.6040**



**Tablett, oval**

serving tray, oval  
plateau de service, ovale  
bandeja, oval  
vassoio, ovale

Größe	size
cm	in.
22 x 15,5	8 <sup>3</sup> / <sub>4</sub> x 6
27 x 20	10 <sup>1</sup> / <sub>2</sub> x 8
29 x 22,5	11 <sup>1</sup> / <sub>2</sub> x 8 <sup>3</sup> / <sub>4</sub>

Cromargan®	versilbert
stainless 18/10	silverplated
<b>06.7540.6040</b>	<b>19.7540.6440</b>
<b>06.7542.6040</b>	<b>19.7542.6440</b>
<b>06.7543.6040</b>	<b>19.7543.6440</b>



**Tablett, oval  
BISTRO**

serving tray, oval  
plateau de service, ovale  
bandeja, oval  
vassoio, ovale

stapelbar /  
stackable

Cromargan® / stainless 18/10

Größe	size
cm	in.
51,6 x 39	20 <sup>1</sup> / <sub>4</sub> x 15 <sup>1</sup> / <sub>4</sub>

06.7681.6040



**Tablett, oval  
CLASSIC**

serving tray, oval  
plateau de service, ovale  
bandeja, oval  
vassoio, ovale

Cromargan® / stainless 18/10

Größe	size
cm	in.
59,5 x 46,7	23 <sup>1</sup> / <sub>2</sub> x 18 <sup>1</sup> / <sub>2</sub>

06.7836.6040\*

\* Maße ohne Griffe / measures without handles



**Kaffeetablett  
PURE**

serving tray  
plateau de service  
bandeja  
vassoio

stapelbar, oval /  
stackable, oval

Cromargan® / stainless 18/10

Größe	size
cm	in.
27 x 17	10 <sup>1</sup> / <sub>2</sub> x 6 <sup>3</sup> / <sub>4</sub>

06.7550.6040



**Tablett, oval  
PURE**

serving tray, oval  
plateau de service, ovale  
bandeja, oval  
vassoio, ovale

passend für Toastständer / suitable for toast rack 06.4280.6040  
und Porzellanschale 3geteilt / and for porcelain bowl 3pcs.

60.3538.9990

stapelbar / stackable

Cromargan® / stainless 18/10

Größe	size
cm	in.
24,5 x 12	9 <sup>1</sup> / <sub>2</sub> x 4 <sup>3</sup> / <sub>4</sub>

06.7551.6040







**Tablett  
URBAN**

tray  
plateau  
bandeja  
vassoio

Cromargan® / stainless 18/10

Größe	size
cm	in.
23 x 10,7	8 x 4 <sup>1</sup> / <sub>4</sub>

55.0058.6045



**Tablett, Gastronorm,  
CLASSIC**

serving tray, Gastronorm  
plateau de service, Gastronorm  
bandeja, Gastronorm  
vassoio, Gastronorm

GN 1/1, rechteckig /  
GN 1/1, rectangular

Größe	size
cm	in.
53 x 32,5	20 <sup>3</sup> / <sub>4</sub> x 12 <sup>3</sup> / <sub>4</sub>

Cromargan®	versilbert
stainless 18/10	silverplated
<b>06.7849.6040</b>	<b>19.7849.6440</b>



**Tablett Gastronorm  
CLASSIC**

serving tray Gastronorm  
plateau de service Gastronorm  
bandeja Gastronorm  
vassoio Gastronorm

rechteckig /  
rectangular

Cromargan® / stainless 18/10

	Größe	size	
	cm	in.	
GN 1/1	53 x 32,5	20 <sup>3</sup> / <sub>4</sub> x 12 <sup>3</sup> / <sub>4</sub>	<b>06.7838.6040</b>
GN 2/1	65 x 53	25 <sup>1</sup> / <sub>2</sub> x 20 <sup>3</sup> / <sub>4</sub>	<b>06.7839.6040</b>

Maße ohne Griffe / measures without handles

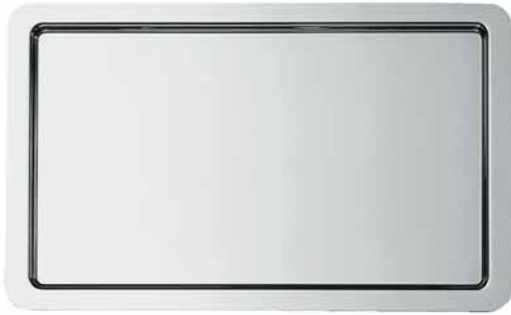

### Tablett, Gastronorm

serving tray, Gastronorm  
 plateau de service, Gastronorm  
 bandeja, Gastronorm  
 vassoio, Gastronorm

rechteckig /  
 rectangular

Cromargan® / stainless 18/10

	Größe cm	size in.	
GN 1/2*	32,5 x 26,5	12 <sup>3</sup> / <sub>4</sub> x 10 <sup>1</sup> / <sub>2</sub>	<b>06.7658.6040</b>
GN 1/1**	53 x 32,5	20 <sup>3</sup> / <sub>4</sub> x 12 <sup>3</sup> / <sub>4</sub>	<b>06.7660.6040</b>
GN 2/1	65 x 53	25 <sup>1</sup> / <sub>2</sub> x 20 <sup>3</sup> / <sub>4</sub>	<b>06.7661.6040</b>

\* Passend auf alle GN 1/2 Rahmen / fitting on all GN 1/2 frames

\*\* Passend auf alle GN 1/1 Rahmen und auf Plattenständer niedrig/hoch/  
 fitting on all GN 1/1 frames and on tray stands low/high



### Tablett Gastronorm BISTRO

serving tray Gastronorm  
 plateau de service Gastronorm  
 bandeja Gastronorm  
 vassoio Gastronorm

GN 1/1, stapelbar, rechteckig /  
 GN 1/1, stackable, rectangular

Cromargan® / stainless 18/10

Größe cm	size in.	
53 x 32,5	20 <sup>3</sup> / <sub>4</sub> x 12 <sup>3</sup> / <sub>4</sub>	<b>06.7680.6040</b>

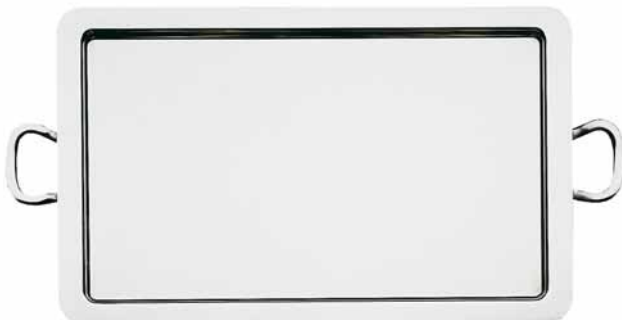

### Tablett Gastronorm NEUTRAL

serving tray Gastronorm  
 plateau de service Gastronorm  
 bandeja Gastronorm  
 vassoio Gastronorm

rechteckig / rectangular

Cromargan® / stainless 18/10

Größe cm	size in.	
GN 1/1	53 x 32,5	20 <sup>3</sup> / <sub>4</sub> x 12 <sup>3</sup> / <sub>4</sub>
GN 2/1	65 x 53	25 <sup>1</sup> / <sub>2</sub> x 20 <sup>3</sup> / <sub>4</sub>

Maße ohne Griffe / measures without handles

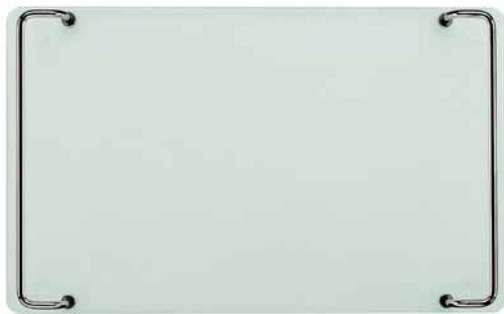

**Tablett, rechteckig, Gastronorm**

serving tray, rectangular, Gastronorm  
 plateau de service, rectangulaire, Gastronorm  
 bandeja, rectangular, Gastronorm  
 vassoio, rettangolare, Gastronorm

GN 1/1, stapelbar, rechteckig, schnittfest, spülmaschinenfest /  
 GN 1/1, stackable, rectangular, resistant against cutting, dishwasher-safe

Kunststoff, Cromargan® - Griffe /  
 high quality plastic, handle stainless 18/10

Größe	size
cm	in.
53 x 32,5	20 <sup>3</sup> / <sub>4</sub> x 12 <sup>3</sup> / <sub>4</sub>

06.7683.6040



**Tablett, rechteckig**

serving tray, rectangular  
 plateau de service, rectangulaire  
 bandeja, rectangular  
 vassoio, rettangolare

Cromargan® / stainless 18/10

Größe	size
cm	in.
40,1 x 29	15 <sup>3</sup> / <sub>4</sub> x 11 <sup>1</sup> / <sub>2</sub>
52,6 x 40,8	20 <sup>3</sup> / <sub>4</sub> x 16

06.7269.6040

06.7271.6040



**Tablett, rechteckig  
 CLASSIC**

serving tray, rectangular  
 plateau de service, rectangulaire  
 bandeja, rectangular  
 vassoio, rettangolare

Cromargan® / stainless 18/10

Größe	size
cm	in.
77,2 x 50,7	30 <sup>1</sup> / <sub>2</sub> x 20

06.7842.6040

Maße ohne Griffe / measures without handles



**Tablett, rechteckig  
 NEUTRAL**

serving tray, rectangular  
 plateau de service, rectangulaire  
 bandeja, rectangular  
 vassoio, rettangolare

Cromargan® / stainless 18/10

Größe	size
cm	in.
52,6 x 40,8	20 <sup>3</sup> / <sub>4</sub> x 16

06.8444.6040

Maße ohne Griffe / measures without handles

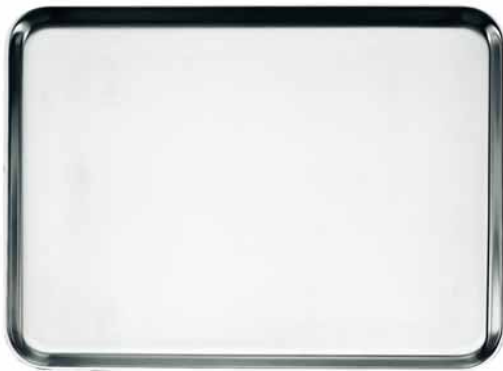

### Tablett, rechteckig

servicing tray, rectangular  
plateau de service, rectangulaire  
bandeja, rectangular  
vassoio, rettangolare

Cromargan® / stainless 18/10

Größe	size
cm	in.
28,5 x 21	11 <sup>1</sup> / <sub>4</sub> x 8 <sup>1</sup> / <sub>4</sub>
33 x 26	13 x 10 <sup>1</sup> / <sub>4</sub>
42,5 x 31,5	16 <sup>3</sup> / <sub>4</sub> x 12 <sup>1</sup> / <sub>2</sub>

06.7585.6040

06.7586.6040

06.7588.6040



### Käseglocke

#### NEUTRAL

cheese dish  
cloche à fromage  
quesera  
porta formaggio

Holzeinsatz Buche / beech wooden insert

	Ø	Ø	
	cm	in.	
passt in Tablett 7262 / fitting tray 7262	36,7	14 <sup>1</sup> / <sub>2</sub>	60.3103.9990

Plexiglashaube / plastic cover

	Ø	Ø	
	cm	in.	
passt zu Einsatz 3103 / fitting insert 3103	34	13 <sup>1</sup> / <sub>2</sub>	06.2864.6040



### Abdeckhaube

cover for trays  
cloche pour plateaux  
campana para bandejas  
coperchio adatto per vassoio

mit 2 seitlichen Eingriffen, passend für Tablett GN <sup>1</sup>/<sub>1</sub> ohne Griffe und Plattenständer niedrig/hoch /  
with two side openings, fitting for trays GN <sup>1</sup>/<sub>1</sub> without handles and on tray stands low/high

Kunststoff glasklar, Griff verchromt /  
high quality plastic, handle chrome plated

Größe	size
cm	in.
55,5 x 35 x 14,5	21 <sup>3</sup> / <sub>4</sub> x 13 <sup>3</sup> / <sub>4</sub> x 5 <sup>3</sup> / <sub>4</sub>

06.2937.6040



### Kuchen-/Tortenplatte

cake plate  
plat à tarte  
plato tarta  
piatto da torta

Cromargan® / stainless 18/10

Höhe	height	Ø	Ø
cm	in.	cm	in.
14,5	5 <sup>3</sup> / <sub>4</sub>	36	14 <sup>1</sup> / <sub>4</sub>

06.4274.6040



# Schönheit besteht. Auch aus guter Pflege.

Beauty endures.  
And good care helps.



Alle WMF Besteckmodelle und Tafelgeräte sind aus edelsten Materialien für intensiven Gebrauch gefertigt. Auch die Bestecke mit perfekter Glanzversilberung sind spülmaschinenfest und unkompliziert zu pflegen. Doch was täglich zum vollen Einsatz kommt, ist hohen Belastungen ausgesetzt.

Damit WMF Produkte lange Zeit in vollem Glanz erstrahlen, empfehlen wir für Silber, Messing und Kupfer die richtige Pflege. Dazu gehören speziell für WMF entwickelte Pflegemittel, um ein Anlaufen von vornherein zu verhindern oder wieder zu entfernen.

Purargan® Silbertauchbad  
Purargan® silver-dip-bath  
Inhalt 5 Liter / cap. 175 oz.  
**14.2826.9990**

Purargan® Silber-Pflegetuch  
Purargan® silver polishing cloth  
**14.2822.9990**

All WMF cutlery models and tableware are made of the finest materials for intensive usage. Even cutlery with superb high-shine silver plating is dishwasher-safe and easy to look after. But every item designed for everyday use has to withstand a great deal of wear and tear.

We want WMF products to keep looking their best for a long time, so we recommend proper care for silver, brass and copper. The care products specially developed for WMF are ideal for preventing tarnish and for removing it.

Purargan® forte, Pflegemittel  
für Silber, Messing und Kupfer  
Purargan® forte, silver, brass  
and copper polish  
Inhalt 1 Liter / cap. 35 oz.  
**14.2831.9990**

Purargan® C, Pflegemittel für  
Silber, Messing und Kupfer  
Purargan® C, silver, brass and  
copper polish  
Inhalt 1 Liter / cap. 35 oz.  
**14.2828.9990**

Artikel	Seite	Artikel	Seite	Artikel	Seite
"4 for you" - Löffel	104	Dressinglöffel	98	Konsole GN 1/6 mit Fuß	201
Abdeckhaube	251, 257	Eierbecher-Set	168	Konsole GN 2/4	202
Adapter für Elektroheizteil	230	Eierlöffel	99, 168	Konsole GN 3/6	201
Adapter GN 1/1	199	Einsatz für Chafing Dish	227	Korkenzieher	173
Adapter GN 1/3	199	Einzelartikel "KaffeeKultur"	132	Krümelsammler	168
Adapter GN 2/3	199	Eisgefäß	165 - 166	Kuchen-/Tortenplatte	257
Adapter GN 2/4	199	Eislöffel XL	104	Kühlakku	250
Allround "CultureCup-Set"	126	Eisröhre	241	Kühlbehälter	249
Allround "KaffeeKultur-Set"	131	Eisschale	160	Kühlelement	243
Ascher	169	Eisschaufel	99	Käsedose	193
Asia-Set	192	Eiswanne GN 1/1	200	Käseglocke	257
Aufsatz GN 1/2	205	Eiswanne GN 1/3	200	Käsemesser	104
Aufsatz GN 1/3	205	Eiswanne GN 2/3	200	Latte Macchiato-Set	126, 130, 135
Beschriftunghalter hinten	208	Eiswanne GN 2/4	200	LEDlight Adapter GN 1/1	206
Beschriftunghalter vorne	208	Eiswasserkrug	164 - 165	LEDlight Adapter GN 1/3	207
Besteckablage	232	Eiszange	96	LEDlight Adapter GN 2/3	206
Bier-/Wasserglas 11	117	Espresso-Set	125, 130	LEDlight Adapter GN 2/4	207
Biertulpe 11	122	Essig-/Ölgestell	185 - 187	LEDlight Einheit	206
Blumenvase	182 - 183	Essig-/Öl-Menage	188 - 190	Légumier	154 - 155
Bordeaux 35	112, 115, 118	Essig-/Öl-Set	186	Leuchter	177 - 178
Bowlenlöffel	98	Ess-Stäbchen Ablage	105	Longdrink 12	121
Brennstoffdose	231	Ess-Stäbchen Paar	105	Löffel "CultureCup"	129
Brennstoffdosenhalter	231	Ess-Stäbchen Set	105	Löffel "KaffeeKultur"	104
Brennstoffhalter Coffee Urn	235	Etagère	247 - 248	Margarita 97	122
Brotkorb	174 - 175	Etagere GN 1/1	206	Marmeladegestell	163
Brotkorb GN 1/1	204	Flaschenteller	153	Martini 25	117
Brotkorb GN 1/2	205	Fleischgabel	94	Menage	158, 192
Brotkorb GN 1/3	204	Früchtekorb	174, 249	Milchdispenser	240 - 241
Brotkorb GN 2/3	204	Gastronorm-Einsatz	229	Milchkaffee-Set	130
Brotkorb GN 2/4	204	Gebäck- und Servierzange	96	Milchkanne	137 - 138
Brotmesser	100	Getränkekühler	150, 243	Milchkännchen	140
Brotschale	175	Getränkekühlerständer	152	Milch-Zucker-Set	142, 144 - 147
Brotschneidebrett GN 1/1	202	Glas L mit Griff	128	Minibar 47	114, 120
Brücke GN 2/4	205	Glas LATTE (VPE 6 Stk.)	128	Mixdrink 09	113, 121
Buffetgestell	213 - 215	Glas S (VPE 6 Stk.)	128	Mokkaétagère	161 - 163, 248
Buffet-Set	244 - 245	Glasbehälter	134	Nudellöffel	95
Burgunder 99	112, 115	Glaskrug	242	Obstschale	176
Butterkühler	155 - 157	Glasschale	249	Petits Fours-Ständer	161 - 162
Café au Lait-Set	131	Gläser-Set	135	Plastik-Tischnummer	173
Café Crème-Set	125, 130	Happy Spoon	103	Platte	227
Cappuccino-Set	125	Heizelement	230 - 231	Platte GN 1/1	202
Ceralien-/Saft-Set	244	Heizelement Coffee Urn	235	Platte GN 1/3	203
Cerealiendispenser	238 - 239	Honig-/Sahnespender	141	Platte GN 2/3	202
Chafing Dish	211 - 212, 218 - 220, 222	Hummergabel	97	Platte GN 2/4	203
Chafing Dish - Besteck	94, 233	Hummerzange	97	Platte GN 3/6	203
Chafing Dish "Metropolitan"	220 - 221	Hygieneschutz	208	Platten	251
Champagner 29	113, 116, 118	Isolierkanne	141	Plattenständer hoch	250
Chillcup	160	Kaffeekanne	137 - 139	Plattenständer niedrig	250
Cocktail 96	122	Kaffeeblett	148, 253	Platzteller	166 - 167
Coffee Urn	234	Kakao-Set	125	Portions-Chafing Dish "Metropolitan"	221
Cognac 18	117	Karaffe	243	Portionsschöpfer	98
Deckel mit Ausschnitt	129, 133	Karaffe 53	124	Porzellanbehälter	129, 134
Dekanter 59	124	Karaffe 57	124	Porzellan-Einsatz	226, 228
Dessertgestell	157 - 159, 245 - 247	Karaffe 58	124	Porzellaneinsatz GN 1/4	207
Destillat 30	116	Kartenhalter	172	Porzellaneinsatz GN 1/6	208
Digestif 23	116	Kartoffellöffel	99	Porzellaneinsatz GN 3/6	207
Doppel-Espresso-Set	131	Kaviarkühler	159	Porzellan-Einsätze	227
Dosenöffner	173	Kaviarlöffel	102	Porzellanschale	148, 163
		Kaviarmesser	103		
		Konsole GN 1/3	201		
		Konsole GN 1/6	201		

Artikel	Seite	Artikel	Seite
Porzellantasse M flach mit Griff	127	Tischnummernständer	170 - 171
Porzellantasse M hoch mit Griff	127	Tischrestebehälter	168
Porzellantasse S mit Griff	127	Toastständer	163
Punchbowl	149	Tortenheber	103
<b>Rahmen GN 1/1</b>	198	Tortennmesser	103
Rahmen GN 1/3	198	Tranchiergabel	101
Rahmen GN 2/3	198	Tranchiermesser	100 - 101
Rahmen GN 3/4	198	Tumbler 15	114, 120
Relish-Pickles-Gestell	164	Tumbler XL 16	120
Rotweinkelch 01	112, 115, 118	<b>Universalschale</b>	155, 176
Rotweinwiege	153	Universalzange	95 - 96
<b>Saftbar</b>	242	<b>Vorlege-/ Aufschnittgabel</b>	100
Saftdispenser	239 - 240	<b>Wasser-/Minibarglas 10</b>	119
Sahne-/Zucker-Set	133	Wasserglas 15 bernstein	123
Sahnegießer	140	Wasserglas 15 oliv	123
Sahnekännchen	134	Wasserglas 15 rauchblau	123
Sahnekännchen (VPE 6 Stk.)	133	Wasserglas 15 rauchgrau	123
Sahne-Zucker-Set	143 - 144	Wein-/Sekt Kühler	150 - 151
Salat-/Vorlegebesteck	94	Weinkorb	153
Salatzange	95	Weinkühler	151
Salz- und Pfeffergestell	185	Weinkühlerständer	152
Salz-/Pfeffer-Set	191	Weissweinkelch 02	112, 115, 118
Salzmühle / Pfeffermühle	184	Windlicht	179 - 180
Salzstreuer / Pfefferstreuer	184	<b>Zahnstocher- und Süßstoffbehälter</b>	169
Saucenlöffel	98	Zahnstocherbehälter	169
Sauciere	154	Zigarrenabschneider	170
Schild mit Kette	235	Zitronenpresse	136
Schnecken gabel	97	Zuckerdose	137 - 140
Schnecken zange	97	Zuckerdosierer	141
Sekt kelch 07	113, 119	Zuckergestell	142 - 143
Senftopf	193	Zuckerstangengefäß	141
Serviergestell	159, 247	Zuckerzange	96
Servier tablett für Zucker	142	Zwischensteg Induktion	232
Sherry/Digestif 04	113		
Sherry/Portwein 04	116		
Short 20	120		
Short 21	121		
Softdrink 14	114, 121		
Speisekartenhalter	172		
Steakbesteck	102		
Steakbesteck SOLID	101		
Steakmesser	102		
Steakmesser*	102		
Suppenmarmite	224 - 226		
Suppenschöpfer	99		
Suppenstation	225		
<b>Tablett</b>	126, 186, 249, 252 - 257		
Tablett Gastronom	254 - 255		
Tasting/Dessertwein 04	119		
Teeglas	135		
Teekanne	137 - 139		
Teelichtleuchter 3fl. klein	181		
Teesieb	136		
Teesieb-Behälter (VPE 6 Stk.)	136		
Teesieb-Einsatz	136		
Teller-/Schalengestell	245		
Teller cloche	167		
Tischnummer	172		
Tischnummern-Aufsteller	173		

Article	Page	Article	Page	Article	Page
"4 for you" spoon	104	connecting shelf	232	ice tube	241
Adapter GN 1/1	199	console GN 1/3	201	ice-shovel	99
Adapter GN 1/3	199	console GN 1/6	201	insert for chafing dish	227
Adapter GN 2/3	199	console GN 1/6 with feet	201	jam stand	163
Adapter GN 2/4	199	console GN 2/4	202	juice bar	242
all-round "CultureCup Set"	126	console GN 3/6	201	juice dispenser	239 - 240
all-round "KaffeeKultur Set"	131	cooler	249	Label holder front	208
ash tray	169	cooling block	250	Label holder rear	208
Asia set	192	cooling element	243	Latte Macchiato Set	126, 130, 135
Beer/Mineral Water Glass 11	117	cork-screw	173	LEDlight adapter GN 1/1	206
beverage cooler	150, 243	cover for trays	251, 257	LEDlight adapter GN 1/3	207
Bordeaux 35	112, 115, 118	creamer	134, 140	LEDlight adapter GN 2/3	206
bowl for bread	174 - 175	creamer (unit 6 pcs.)	133	LEDlight adapter GN 2/4	207
Brandy Glass 18	117	decanter	243	LEDlight unit	206
Bread basket GN 1/1	204	Decanter 59	124	lemon/orange squeezer	136
Bread basket GN 1/2	205	dessert stand	157 - 159, 245 - 247	lid with cut-out	129, 133
Bread basket GN 1/3	204	Destillate 30	116	lobster fork	97
Bread basket GN 2/3	204	Digestive 23	116	lobster-crack	97
Bread basket GN 2/4	204	dressing ladle	98	Longdrink 12	121
Bread cutting board GN1/1	202	egg cup set	168	Margarita 97	122
bread knife	100	egg spoon	99, 168	Martini 25	117
bread-basket	174 - 175	espresso double set	131	meat fork	101
Bridge GN 2/4	205	espresso set	125, 130	menage	158, 192
buffet set	244 - 245	etagere	247 - 248	menu stand	172
Burgundy 99	112, 115	finger bowl	155, 176	milk dispenser	240 - 241
burner holder	231	flower vase	182 - 183	milk jug	137 - 138
burner holder coffee urn	235	Flute Champagne 07	113, 119	Mineral Water/Minibar 10	119
butter cooler	155 - 157	frame	213 - 215	Minibar 47	114, 120
café au lait set	131	Frame GN 1/1	198	Mixdrink 09	113, 121
café crème set	125, 130	Frame GN 1/3	198	mustard pot	193
caffè Latte set	130	Frame GN 2/3	198	name plate with chain	235
cake knife	103	Frame GN 2/4	198	oil and vinegar set	185 - 190
cake plate	257	fruit basket	174, 249	parmesan jar	193
can opener	173	fruit stand	176	pasta serving spoon	95
candelabra	178	fuel gel cartridge	231	pastry serving tongs	95 - 96
candle stick	177	glass bowl	249	pastry stand	161 - 163, 248
cappuccino set	125	glass dish	134	petits-fours-stand	161 - 162
Carafe 53	124	glass L with handle	128	pie server	103
Carafe 57	124	glass LATTE (unit 6 pcs.)	128	plastic table number	173
Carafe 58	124	glass pitcher	242	plate and bowl stand	245
card holder	172	glass S (unit 6 pcs.)	128	plate cover	167
carving knife	100 - 101	glass set	135	Plate GN 1/1	202
caviar cooler	159	GN insert	229	Plate GN 1/3	203
caviar knife	103	GN porcelain insert	228	Plate GN 2/3	202
caviar spoon	102	gravy boat	154	Plate GN 2/4	203
cereal dispenser	238 - 239	gravy ladle	98	Plate GN 3/6	203
Chafing Dish	211 - 212, 218 - 222	happy spoon	103	plate tray	166 - 167
chafing dish serving set	94, 233	heating element	230 - 231, 235	platter	227
Champagne 29	113, 116, 118	holder for heating element	230	platters	251
cheese dish	257	honey/cream dispenser	141	porcelain bowl 3-section	148, 163
cheese knife	104	hygienic cover	208	porcelain cup M high	
chillcup	160	ice bucket	165 - 166	with handle	127
chopstick set	105	ice cream bowl	160	porcelain cup M low	
chopstick stand	105	Ice pan GN 1/1	200	with handle	127
chopsticks pair	105	Ice pan GN 1/3	200	porcelain cup S with handle	127
cigar cutter	170	Ice pan GN 2/3	200	porcelain dish	129, 134
coaster for bottles	153	Ice pan GN 2/4	200	porcelain insert	226 - 227
Cocktail 96	122	ice spoon XL	104	porcelain insert GN 1/4	207
cocoa set	125	ice tongs	96	porcelain insert GN 1/6	208
coffee pot	137 - 139				
coffee urn	234				



Article	Page	Article	Page
porcelain insert GN $\frac{3}{6}$	207	tealight candle stick	181
potato spoon	99	toast rack	163
punch bowl	149	toothpick- and sweetener	
punch bowl ladle	98	box-holder	169
		toothpick-holder	169
rack for utensils	232	top frame GN $\frac{1}{2}$	205
red wine cradle	153	top frame GN $\frac{1}{3}$	205
Red Wine Goblet 01	112, 115, 118	tray	186, 254
		tray stand high	250
relish or condiment server	164	tray stand low	250
		Tulip Beer Glass 11	122
salad serving tongs	95	Tumbler 15	114, 120
salad/buffet serving set	94	Tumbler 15 amber	123
salt and pepper set	191	Tumbler 15 olive	123
salt mill / pepper mill	184	Tumbler 15 smoky blue	123
salt shaker / pepper shaker	184	Tumbler 15 smoky grey	123
salt-pepper-set	185	Tumbler XL 16	120
service tray	249		
servicing fork	94, 100	universal dish	155, 176
servicing stand	159, 247		
Servicing stand GN $\frac{1}{1}$	206	vacuum jug	141
servicing tray	126, 148, 252 - 257	vegetable dish and cover	154 - 155
servicing tray for sugar	142	water pitcher	164 - 165
servicing tray Gastronorm	254 - 255	White Wine Goblet 02	112, 115, 118
set for cereal/juice dispenser	244		
Sherry/Digestive 04	113	wine / champagne cooler	150 - 151
Sherry/Port 04	116	wine cooler	151
Shot 20	120	wine-basket	153
Shot 21	121		
silent waiter	168		
single items "KaffeeKultur"	132		
snail fork	97		
snail tweezer	97		
Softdrink 14	114, 121		
soup ladle	98 - 99		
soup tureen	224 - 226		
spoons "CultureCup"	129		
spoons "KaffeeKultur"	104		
stand for beverage cooler	152		
stand for wine/champagne cooler	152		
steak flatware	102		
steak fork and knife SOLID	101		
steak knife	102		
steak knife*	102		
sugar and creamer set	142 - 143		
sugar and milk set	133, 144 - 147		
sugar basin	137 - 140		
sugar dispenser	141		
sugar pack holder	141		
sugar server	142		
sugar set	143		
sugar tongs	96		
table crumbler	168		
table lamp	179 - 180		
table lamp with glass	179		
table number	172 - 173		
table number stand	170 - 171		
Tasting/dessert wine 04	119		
tea glass	135		
tea pot	137 - 139		
tea strainer	136		
tea strainer holder (unit 6 pcs.)	136		
tea strainer insert	136		

Article	Page	Article	Page	Article	Page
Adaptateur GN 1/1	199	Corbeille à pain GN 2/4	204	happy spoon	103
Adaptateur GN 1/3	199	Corniche GN 1/2	205	huilier-vinaigrier	185 - 190
Adaptateur GN 2/3	199	Corniche GN 1/3	205	Incrustation porcelaine GN 1/4	207
Adaptateur GN 2/4	199	coupe à fruits	176	Incrustation porcelaine GN 1/6	208
adaptateur pour plaque électrique	230	coupe à glace	160	Incrustation porcelaine GN 3/6	207
Adaptateur ampoule LED GN 1/1	206	Coupe de champagne 07	113, 119	intérieur en porcelaine	226 - 227
Adaptateur ampoule LED GN 2/3	206	Coupe de vin blanc 02	112, 115, 118	intérieur pour chafing dish	227
Adaptateur ampoule LED GN 1/3	207	Coupe de vin rouge 01	112, 115, 118	kit "CultureCup" polyvalent	126
Adaptateur ampoule LED GN 2/4	207	coupe en porcelaine		kit "KaffeeKultur" polyvalent	131
articles isolés "KaffeeKultur"	132	3 parties	148, 163	kit ASIA	192
assiette de présentation	166 - 167	coupe réfrigérante	249	kit baguettes	105
Bac à glace GN 1/1	200	coupe universelle	155, 176	kit cacao	125
Bac à glace GN 1/3	200	coupe verre glasskin	249	kit café au lait	130 - 131
Bac à glace GN 2/3	200	coupe-cigares	170	kit café crème	125, 130
Bac à glace GN 2/4	200	couteau à caviar	103	kit cappuccino	125
baguettes paire	105	couteau à fromage	104	kit espresso	125, 130
bar à jus de fruit	242	couteau à pain	100	kit espresso double	131
bati	213 - 215	couteau à steak	102	kit latte-macchiato	126, 130
Boisson mélangée 09	113, 121	couteau à steak*	102	latte-macchiato-set	135
Boisson sans alcool 14	114, 121	couteau à tarte	103	légumier et couvercle	154 - 155
boîte de table	168	couteau à viande	100 - 101	Long drink 12	121
boîtes de gel combustible	231	couvercle avec découpe	129, 133	louche	98
bol à punch	149	couvert à salade/servir	94	louche à potage	99
Bordeaux 35	112, 115, 118	couvert à steak	102	Margarita 97	122
Bourgogne 99	112, 115	couvert à steak SOLID	101	marmite à potage	224 - 226
brique réfrigérante	250	crémier	134, 140	Martini 25	117
broc en verre	242	crémier (UV 6 pc.)	133	menagère	158, 192
Cadre GN 1/1	198	cuiller "4 for you"	104	ménagère 2 pièces	185
Cadre GN 1/3	198	cuiller à caviar	102	ménagère 3 pièces	191
Cadre GN 2/3	198	cuiller à glace	99	Minibar 47	114, 120
Cadre GN 2/4	198	cuiller à glace XL	104	moulin à sel / moulin à poivre	184
cafétière	137 - 139	cuiller à oeuf	99, 168	moutardier	193
carafe	243	cuiller à pommes de terre	99	numéro de table	172 - 173
Carafe 53	124	cuiller à punch	98	numéro de table en plastique	173
Carafe 57	124	cuiller à sauce	98	ouvre-boîte	173
Carafe 58	124	cuillère à spaghetti	95	panier à fruits	174, 249
carafe à l'eau	164	cuillers "CultureCup"	129	panier à pain	174 - 175
carafe à l'eau	164 - 165	cuillers "KaffeeKultur"	104	panier à vin	153
cendrier	169	Décanteur 59	124	passoire	136
Chafing Dish	211 - 212, 218 - 222	Dégustation/vin de		passoire à thé	136
Champagne 29	113, 116, 118	dessert 04	119	pelle à gâteau	103
chandelier	177 - 178	dessous de bouteille	153	pince à escargots	97
chandelier avec verrine	179 - 180	Digestif 23	116	pince à gâteau	95 - 96
chandelier bougie		dispenseur de céréales	238 - 239	pince à glace	96
à chauffe-plat	181	dispenseur de jus	239 - 240	pince à homard	97
chillcup	160	dispenseur de lait	240 - 241	pince à salade	95
cloche à fromage	257	Distillat 30	116	pince à sucre	96
cloche pour assiette	167	distributeur à miel / crème	141	Planche à pain GN 1/1	202
cloche pour plateaux	251, 257	élément réfrigérante	243	planche pour recipient	251
Cocktail 96	122	ensemble buffet	244 - 245	plaque électrique	230 - 231, 235
coffee urn	234	étagère	247 - 248	Plaque GN 1/1	202
Cognac 18	117	Etagère GN 1/1	206	Plaque GN 1/3	203
Console GN 1/3	201	étiquette avec chaîne	235	Plaque GN 2/3	202
Console GN 1/6	201	Flûte à bière 11	122	Plaque GN 2/4	203
Console GN 1/6 avec pied	201	fourchette à escargots	97	Plaque GN 3/6	203
Console GN 2/4	202	fourchette à homard	97	plat	227
Console GN 3/6	201	fourchette à viande	94, 100 - 101	plat à tarte	257
Corbeille à pain GN 1/1	204	fromagère	193	plateau	186, 254
Corbeille à pain GN 1/2	205	GN intérieur	228 - 229		
Corbeille à pain GN 1/3	204				
Corbeille à pain GN 2/3	204				

Article	Page	Article	Page
plateau de service	126, 148, 249, 252 - 257	à champagne	152
plateau de service Gastronorm	254 - 255	tasse en porcelaine M haute avec anse	127
plateau de service pour sucre	142	tasse en porcelaine M plate avec anse	127
Pont GN 2/4	205	tasse en porcelaine S avec anse	127
porte brûleur	231	théière	137 - 139
porte brûleur coffee urns	235	tire-bouchon	173
porte menu	172	traverse	232
porte numéro de table	170 - 171	tube à glace	241
porte petits fours	161 - 163, 248	Tumbler 15	114, 120
porte-bouteille	153	Tumbler XL 16	120
porte-carte	172	<b>Unité</b> ampoule LED	206
porte-cure-dents	169	vase à fleurs	182 - 183
porte-cure-dents et récipient pour sucrettes	169	Verre à bière/eau 11	117
pot à lait	137 - 138	Verre à eau 15 ambre	123
pot isotherme	141	Verre à eau 15 bleu fumé	123
pots à lait	140	Verre à eau 15 gris fumé	123
pots à sucriers	141	Verre à eau 15 olive	123
présentoir à assiette	159, 247	Verre à eau/minibar 10	119
présentoir a cereales/ jus de fruit	244	verre à thé	135
présentoir à gâteau	157 - 159, 245 - 247	verre L avec anse	128
presse-citron	136	verre LATTE (UV 6 pc.)	128
Protection hygiénique	208	verre S (UV 6 pc.)	128
ramasse-brosse	168	<b>Xérès</b> /digestif 04	113
rangement pour baguettes	105	Xérès/porto 04	116
récipient en porcelaine	129, 134		
récipient en verre	134		
refraîchisseur à beurre	155 - 157		
refraîchisseur à caviar	159		
saucière	154		
saupoudreuse à sucre	141		
seau à boisson	150, 243		
seau à glace	165 - 166		
seau à vin	151		
seau à vin / champagne	150 - 151		
service à relish	164		
service à sucre	142		
service à sucriers	143		
service pots à lait / sucriers	133, 142 - 147		
service pour chafing dish	94, 233		
set à glass	135		
set de coquetier	168		
Short 20	120		
Short 21	121		
soucoupe pour passoire à thé (UV 6 pc.)	136		
sucrier	137 - 140		
support couverts à servir	232		
support pour bols à céréales	245		
support pour confiture	163		
Support pour inscription arrière	208		
Support pour inscription avant	208		
support pour pain grillé	163		
support pour plaques bas	250		
support pour plaques haut	250		
support pour seau à boisson	152		
support pour seau			

Articulo	Página	Articulo	Página	Articulo	Página
abrelatas	173	cremera (UV 6 p.)	133	Jarra 58	124
acumulador refrigerador	250	cubierto ensalada/servir	94	jarra agua	164 - 165
Adaptador GN 1/1	199	cubierto servir chafing dish	94	jarra de cristal	242
Adaptador GN 1/3	199	cubierto steak	102	jarra isotérmica	141
Adaptador GN 2/3	199	cubierto steak SOLID	101	Jerez/digestivo 04	113
Adaptador GN 2/4	199	cubiertos para chafing dish	233	Jerez/vino de Oporto 04	116
adaptador para placa		culo bebida	150, 243	juego ASIA	192
calentadora	230	culo hielo	165 - 166	juego azucarero	143
artículos diversos		culo vino	151	juego azucarero / cremera	133,
"KaffeeKultur"	132	culo vino / champán	150 - 151		142 - 147
azucarero	137 - 140	cuchara "4 for you"	104	juego cacao	125
azucarero para azúcar en cañas	141	cuchara caviar	102	juego café con leche	130 - 131
		cuchara huevos	99, 168	juego café-crème	125, 130
<b>bajoplato</b>	166 - 167	cuchara pasta	95	juego capuchino	125
bandeja	126, 148,	cucharas "CultureCup"	129	juego de bufete	244 - 245
	186, 249,	cucharas "KaffeeKultur"	104	juego de palillos	105
	252 - 257	cucharon patatas	99	juego espresso	125, 130
bandeja con azucareros	142	cuchillo carne	100 - 101	juego espresso doble	131
bandeja Gastronorm	254 - 255	cuchillo caviar	103	juego latte macchiato	126, 130,
Borgoña 99	112, 115	cuchillo pan	100		135
Burdeos 35	112, 115,	cuchillo queso	104	juego palillos	105
	118	cuchillo steak	102	juego universal para el	
		cuchillo steak*	102	"CultureCup"	126
<b>cafetera</b>	137 - 139	cuchillo tarta	103	juego universal para el	
campana	167	cuenco de porcelana		"KaffeeKultur"	131
campana con pomo	167	3 divisiones	148, 163	juego vasos	135
campana para bandejas	251, 257				
candelabro	178	<b>Decantador 59</b>	124	<b>lechera</b>	137 - 138
candelero	177	depósito de combustible	231	LEDluz Adaptador GN 1/1	206
candelero lamparilla	181	depósito para chafing dish	227	LEDluz Adaptador GN 1/3	207
Cata/vino dulce 04	119	depósitos de cristal	249	LEDluz Adaptador GN 2/3	206
cazo ponche	98	Destilado 30	116	LEDluz Adaptador GN 2/4	207
cazo porciones	98	Digestivo 23	116	LEDluz unidad	206
cazo salsa	98	dispensador de cereales	238 - 239	legumbreira con tapa	154 - 155
cazo sopa	99	dispensador de zumo	239 - 240	linterna con cristal	179 - 180
cenicero	169	dispensador leche	240 - 241		
cesta del pan	174 - 175	dispensador miel / nata	141	<b>Marco GN 1/1</b>	198
cesta vino	153	dosificador azúcar	141	Marco GN 1/3	198
Chafing Dish	211 - 212,			Marco GN 2/3	198
	218 - 222	<b>elemento refrigerador</b>	243	Marco GN 2/4	198
Champán 29	113, 116,	enfriador caviar	159	Margarita 97	122
	118	enfriador para mantequilla	155 - 157	Martini 25	117
Coche hielo GN 1/1	200	Etagère GN 1/1	206	Minibar 47	114, 120
Coche hielo GN 1/3	200	etiqueta con cadena	235	molinillo sal /	
Coche hielo GN 2/3	200	exprimidor para limones	136	molinillo pimienta	184
Coche hielo GN 2/4	200			mostacero	193
Cóctel 96	122	<b>florero</b>	182 - 183		
Combinado 09	113, 121	frutero	174, 176,	<b>número de mesa</b>	172 - 173
Coñac 18	117		247 - 249	número de mesa plastico	173
Consola GN 1/3	201	frutero articulado	248		
Consola GN 1/6	201	fuelle	227, 251	<b>pala para hielo</b>	99
Consola GN 1/6 con pie	201			pala para hielo XL	104
Consola GN 2/4	202	<b>garrafa</b>	243	pala tarta	103
Consola GN 3/6	201	GN interior	229	palillero	169
Copa 12	121	GN interior porcelana	228	palillero y dispensador	
copa cóctel mariscos	160			de edulcorante	169
Copa de vino blanco 02	112, 115,	<b>happy spoon</b>	103	panera	174 - 175
	118			Panera GN 1/1	204
Copa de vino espumoso 07	113, 119	interior colador té	136	Panera GN 1/2	205
Copa de vino tinto 01	112, 115,	interior de porcelana	227	Panera GN 1/3	204
	118	Interior de porcelana GN 1/4	207	Panera GN 2/3	204
copa helado	160	Interior de porcelana GN 1/6	208	Panera GN 2/4	204
Copa pequeña 20	120	Interior de porcelana GN 3/6	207	pasarela	232
Copa pequeña 21	121	interior porcelana	226	pinza caracoles	97
Copa tulipa 11	122			pinza de azúcar	96
cortapuros	170	<b>Jarra 53</b>	124	pinza hielo	96
cremera	134, 140	<b>Jarra 57</b>	124	pinza para ensalada	95



Artículo	Página	Artículo	Página
pinza para langostas	97	de café	235
pinza pasteles	95 - 96	Suplemento GN 1/2	205
placa calentadora	230 - 231, 235	Suplemento GN 1/3	205
place calentadora	230	Tabla de cortar pan GN 1/1	202
Plato GN 1/1	202	tapa con recorte	129, 133
Plato GN 1/3	203	taza de procelana M alta	
Plato GN 2/3	202	con asa	127
Plato GN 2/4	203	taza de procelana M baja	
Plato GN 3/6	203	con asa	127
plato tarta	257	taza de procelana S con asa	127
ponchera	149	tenedor bogavante	97
porta aperitivos	164	tenedor caracoles	97
porta menus	172	tenedor carne	94, 100 - 101
porta número de mesa	170 - 171	tetera	137 - 139
porta número de mesa (sin número)	171	tubo para hielo	241
portabotella	153	urna de café	234
portabotellas	153	Vaso de agua 15 ámbar	123
portacubos champán	152	Vaso de agua 15 azul humo	123
portapastas	161 - 163, 248	Vaso de agua 15 gris humo	123
portatarjetas	172	Vaso de agua 15 verde oliva	123
portatostadas	163	vaso L con asa	128
Protección higiénica	208	vaso LATTE (UV 6 p.)	128
Puente GN 2/4	205	Vaso para agua/minibar 10	119
quesera	257	Vaso para cerveza/agua 11	117
recipiente	193, 249	vaso S (UV 6 p.)	128
recipiente colador	136	vaso té	135
recipiente colador té (UV 6 p.)	136	Vaso tubo 15	114, 120
recipiente de cristal	134	Vaso tubo XL 16	120
recipiente de porcelana	134, 226	vinagreras	185 - 190
recipiente de procelana	129		
recipiente desperdicios	168		
recipiente sopa	224 - 225		
recipiente universal	155, 176		
recogemigas	168		
Refresco 14	114, 121		
sacacorchos	173		
salsera	154		
servicio condimento	185, 191		
servicio de azúcar	142		
set 3 recipientes	158, 192		
set de huevera	168		
set para cereales/jugo	244		
set para zumos	242		
sopera para chafing dish	225 - 226		
soporte buffet	213 - 215		
soporte cubiertos servir	232		
Soporte para etiqueta			
parte delantera	208		
Soporte para etiqueta			
parte trasera	208		
soporte para mermelada	163		
soporte para palillos	105		
soporte para platos o fuentes	245		
soporte plato postre	157 - 159, 245 - 246		
soporte platos	159, 247		
soporte platos alto	250		
soporte platos bajo	250		
soporte platos postre	159, 247		
soporte quemador	231		
soporte quemador urna			

Articolo	Pagina	Articolo	Pagina	Articolo	Pagina
abriscatole	173	raccogliogocce	136	LEDlight Adattatore GN 1/1	206
Accessorio GN 1/2	205	colonna per secchio spumante	152	LEDlight Adattatore GN 1/3	207
Accessorio GN 1/3	205	coltellino per caviale	103	LEDlight Adattatore GN 2/3	206
Adattatore GN 1/1	199	coltello carne	100 - 101	LEDlight Adattatore GN 2/4	207
Adattatore GN 1/3	199	coltello da bistecca	102	LEDlight Unità	206
Adattatore GN 2/3	199	coltello da bistecca*	102	legumiera con coperchio	154 - 155
Adattatore GN 2/4	199	coltello formaggio	104	Longdrink 12	121
adattatore per piastra riscaldante	230	coltello pane	100		
Alzata GN 1/1	206	coltello torta	103	<b>macinasale / macinapepe</b>	184
alzata per frutta	176	contenitore per		Margarita 97	122
alzata porta dolci	161 - 162	colino tè (UV 6 p.)	136	Martini 25	117
alzata portadolci	161 - 163, 248	coperchio adatto per vassoio	251, 257	menage	185, 191
		coperchio con punto aperto		ménage per tapenade	158, 192
		per cucchiaino	129, 133	Mensola GN 1/3	201
<b>base</b>	249	coppa gelato	160	Mensola GN 1/6	201
Bicchiere acqua/birra 11	117	copripiatto con pomolo	167	Mensola GN 1/6 con piede	201
Bicchiere acqua/minibar 10	119	cremiera	140	Mensola GN 2/4	202
bicchiere da tè	135	cucchiaini "CultureCup"	129	Mensola GN 3/6	201
Bicchiere di acqua 15 ambra	123	cucchiaini "KaffeeKultur"	104	mestolino salsa	98
Bicchiere di acqua 15 blu fumo	123	cucchiaino "4 for you"	104	Minibar 47	114, 120
Bicchiere di acqua 15 grigio fumo	123	cucchiaino per bowl	98	Mixdrink 09	113, 121
Bicchiere di acqua 15 verde		cucchiaino per caviale	102		
oliva	123	cucchiaino per patate	99	<b>numero tavolo</b>	172 - 173
bicchiere L con maniglia	128	cucchiaino per uovo	99, 168	numero tavolo in plastica	173
bicchiere LATTE (UV 6 p.)	128	cucchiaino per gelato	99		
bicchiere S (UV 6 p.)	128	cucchiaino per gelato XL	104	<b>oliera</b>	185 - 190
Bordeaux 35	112, 115, 118	cucchiaino per pasta	95		
		<b>Decanter 59</b>	124	<b>paio bacchette</b>	105
Borgogna 99	112, 115	Digestivo 23	116	pala da torta	103
bowl per punch	149	dispenser cereali	238 - 239	piastra riscaldante	230 - 231, 235
bricchetto per il latte	134	dispenser latte	240 - 241	piatto	251
bricchetto per il latte (UV 6 p.)	133	dispenser per succhi di frutta	239 - 240	piatto da torta	257
brocca di vetro	242	Distillati 30	116	Piatto GN 1/1	202
brocca per acqua	164 - 165			Piatto GN 1/3	203
		<b>elemento per il ghiaccio</b>	243	Piatto GN 2/3	202
				Piatto GN 2/4	203
<b>caffettiera</b>	137 - 139	<b>Flûte 29</b>	113, 116, 118	Piatto GN 3/6	203
Calice da birra 11	122			piatto segneposto	166 - 167
Calice da spumante 07	113, 119	forchetta aragosta	97	pinza per aragoste	97
Calice da vino bianco 02	112, 115, 118	forchetta da antipasto	94, 100	pinza per ghiaccio	96
		forchetta per lumache	97	pinza per lumache	97
Calice da vino rosso 01	112, 115, 118	forchettone	101	pinza per zucchero	96
		formaggiara	193	pinza servire insalata	95
candeliere	177 - 178	fornello	231	pinza servire per dolci	96
candeliere lumino	181	fornello coffee urn	235	pinza universale	95 - 96
Caraffa 53	124	fruttiera	174, 249	Ponte GN 2/4	205
Caraffa 57	124			ponticello	232
Caraffa 58	124	<b>GN interno</b>	229	porta formaggio	257
carraffa termica	141	GN interno in porcellana	228	porta frutta	247 - 248
cavatappi	173			porta piattini per dessert	157 - 159, 245 - 247
cestino per il pane	174 - 175	<b>happy spoon</b>	103	porta posante	232
Cestino portapane GN 1/1	204			porta rifiuti per tavolo	168
Cestino portapane GN 1/2	205	inserto piatto chafing dish	227	porta stuzzicadenti	169
Cestino portapane GN 1/3	204	Inserto porcellana GN 1/4	207	porta stuzzicadenti	
Cestino portapane GN 2/3	204	Inserto porcellana GN 1/6	208	e contenitore per dolcificante	169
Cestino portapane GN 2/4	204	Inserto porcellana GN 3/6	207	portacarta	172
cestino portavino	153	interno in porcellana	226 - 227	portamenu	172
Chafing Dish	211 - 212, 218 - 222	interno in vetro	249	portaoggetti per bacchette	105
				portapane	174 - 175
chillcup	160	<b>lampa da tavola alta</b>		portapiatti	159, 247
ciotola universale	155, 176	c. paralum	180	portasalatini / olive	164
Cocktail 96	122	lampa da tavola alta		porta-toast	163
coffee urn	234	con paralume	179 - 180	posacenero	169
Cognac 18	117	lattiera	137 - 138, 140	posate chafing dish	94, 233
colino per tè	136			posate da bistecca	102
colino per tè con vaschetta		lattine di gel carburante	231		

<b>Articolo</b>	<b>Pagina</b>	<b>Articolo</b>	<b>Pagina</b>
posate da bistecca SOLID	101	tassa di porcellana S	127
posate servire insalata	94	con maniglia	119
Protezione igienica	208	Tasting/vino da dessert 04	250
raccoglibriciole	168	tavoletta per il ghiaccio	137 - 139
ramaiolo	98 - 99	teiera	213 - 215
recipiente di porcellana	129, 134	telaio	198
recipiente di vetro	134	Telaio GN 1/1	198
rinfrecavino / spumante	151	Telaio GN 1/3	198
rinfresca bevanda	150, 243	Telaio GN 2/3	198
rinfresca-burro	155 - 157	Telaio GN 2/4	198
rinfresca-caviale	159	tubo in acciaio	241
rinfrescavino	151	Tumbler 15	114, 120
rinfrescavino / spumante	150 - 151	Tumbler XL 16	120
salsiere	154	Vasca ghiaccio GN 1/1	200
secchiello da ghiaccio	166	Vasca ghiaccio GN 1/3	200
secchiello da ghiaccio	165 - 166	Vasca ghiaccio GN 2/3	200
segnatavola	170 - 171	Vasca ghiaccio GN 2/4	200
senapiera	193	vaso da fiori	182 - 183
set "CultureCup" completo	126	vassoietto tripartito	148, 163
set "KaffeeKultur" completo	131	portazucchero	126, 148,
set ASIA	192	vassoio	186, 227,
set bacchette	105		249,
set cacao	125		252 - 257
set café au lait	131	vassoio Gastronorm	254 - 255
set café crème	125, 130	vassoio per zucchero	142
set café espresso doppio	131	versamiele / versalette	141
set café latte	130	versavino	153
set cappuccino	125	versazucchero	141
set da bicchieres	135		
set da café espresso	125, 130	zuccheriera	137 - 140,
set girevole per succhi			142
di frutta	242	zuppiera	224 - 225
set latte-macchiato	126, 130,	zuppiera per chafing dish	225 - 226
	135		
set lattiera zuccheriera	133,		
	142 - 147		
set per buffet	244 - 245		
set per cereali/succhi	244		
set portauovo	168		
set zuccheriera	141, 143		
Sherry/digestivo 04	113		
Sherry/Porto 04	116		
Short 20	120		
Short 21	121		
singolo articolo "KaffeeKultur"	132		
Softdrink 14	114, 121		
sottobottiglia	153		
spremilimone	136		
spuntasigari	170		
Supporto etichetta anteriore	208		
Supporto etichetta posteriore	208		
supporto per confetture	163		
supporto per piatti e coppe	245		
supporto piatto alto	250		
supporto piatto basso	250		
Tagliere per pane GN 1/1	202		
targhetta ad appoggio per			
numero tavolo	170		
targhetta con aggancio			
a catenella	235		
tassa di porcellana M			
alta con maniglia	127		
tassa di porcellana M			
bassa con maniglia	127		







Showrooms  
Sales offices in Germany

#### **Birkenfeld**

Carl-Benz-Straße 10  
75217 Birkenfeld  
Tel. +49 (0) 72 31/4885 500  
Fax +49 (0) 72 31/4885 590  
info@wmf-professional.de

#### **Frankfurt**

Otto-Volger-Straße 5  
65843 Sulzbach  
Tel. +49 (0) 61 96/7500 07  
Fax +49 (0) 61 96/7488 2  
verkaufsbuero.sulzbach@wmf.de

#### **Berlin**

Am Borsigturm 15  
13507 Berlin  
Tel. +49 (0) 30/4966 511  
Fax +49 (0) 30/4969 806  
verkaufsbuero.berlin@wmf.de

#### **Hamburg**

Mönckebergstraße 13  
20095 Hamburg  
Tel. +49 (0) 40/2303 21  
Fax +49 (0) 40/2368 7731  
verkaufsbuero.hamburg@wmf.de

#### **München**

Sonnenstraße 19  
85764 Oberschleißheim  
Tel. +49 (0) 72 31/4885 500  
Fax +49 (0) 72 31/4885 590  
info@wmf-professional.de

Tochtergesellschaften  
Subsidiaries

#### **WMF in Österreich GmbH**

Etrichgasse 13  
6020 Innsbruck  
Austria  
Tel. +43 512 33 02-0  
Fax +43 512 33 02-97  
gastro@wmf.at

#### **WMF Schweiz AG**

Bernstraße 90  
8953 Dietikon  
Switzerland  
Tel. +41 43 322 93 33  
Fax +41 43 322 93 99  
gastro@wmf.ch

#### **WMF Española, S.A.**

Avda. Llano Castellano, 15  
28034 Madrid/Spain  
Tel. +34 91 334 12 15/14  
Fax +34 91 729 32 22  
hotel@wmf.es

#### **WMF France S.A.R.L.**

13/15 rue Nicolas Ledoux  
94000 Creteil  
France  
Tel. +33 1 49 80 80 10  
Fax +33 1 49 80 70 90  
info@wmf.fr

#### **WMF United Kingdom Ltd.**

31 Riverside Way  
Uxbridge  
Middlesex UB8 2YF  
United Kingdom  
Tel. +44 1895 816 100  
Fax +44 1895 816 105  
tableware@wmf.uk.com

#### **WMF Japan Corp. K.K.**

23-5, Nishishinbashi 3-Chome Minato-ku  
Tokyo 105-0003  
Japan  
Tel. +81 3 5408 3301  
Tel. +81 3 5408 3302 (hotel)  
Fax +81 3 5408 3311  
info@wmf-japan.co.jp  
wmfj@wmf-japan.co.jp

#### **WMF Shanghai Co. Ltd.**

1101-1102 International  
Capital Plaza  
1318 North SiChuan Road  
Hongkou District  
Shanghai 200086  
P.R. China  
Tel. +86 21 5515 5212  
Fax +86 21 5515 5220  
info@wmf-china.com

proHeq GmbH  
WMF Professional

Carl-Benz-Straße 10 · 75217 Birkenfeld · Germany  
Phone: +49 7231 4885 500 · Fax: +49 7231 4885 590  
info@wmf-professional.de · www.wmf-professional.de

63.8080.9990 · Printed in Germany 02.18

Alle Angaben sind unverbindlich. Druckfehler, Änderungen und Irrtum für den gesamten Inhalt vorbehalten.  
All data without obligation. The entire content is subject to misprints, changes and errors.

