

ZIEHER

2017



PROFESSIONAL





Buffet

5

- Zieher buffet systems: "Skyline" / "Squareline" / "Curve"
- buffet stands "Stablo"
- buffet bridges and trays "Podia"
- The "Zieher-system": "Classy" / "Neo" / "Pearl" / "Antique"
"Lightning Buffet" / "U-Turn" / "Solid" / "V12"
"Carbon 4.0" / "Konkret!" / "Basic"
- buffet platters made of laminated plastic, glass and natural stone
- buffet steps
- buffet bowls made of pewter alloy, brass, stoneware, shell, glass, stainless steel, china and walnut
- serving tongs and servers
- fingerfood trees
- serving trays and buffet systems made of walnut: "Mercato" / "Solid"
- etagere "Choice" and display "TriBo"
- rail system "Move"

Catering

121

- melamine trays and accessories in GN sizes: "CaterLog"
- tray system "Modul":
 - walnut
 - melamine
 - glass and china inserts

China, glass and more!

141

- main series and small series made of china / glass
- china plates, platters, trays, bowls and small bowls
- glass plates, platters, trays, bowls and small bowls
- shell series "Capiz"
- cloches made of glass and china
- dinner plates

Wine glasses and more!

202

- champagne flute VAGANZA
- wine glass series VISION
- wine decanter "Eddy"

Miniatures

210

- anti-slip coasters made of silicone
- borosilicate glass, double-walled glass, glass miniatures
- china miniatures
- stainless steel miniatures
- party cutlery, amuse gueule / tapas spoons, glass and honey spoons
- skewers and natural stone

Cruet stands, trays and more!

245

- chocolate / truffles box, suitable inserts made of solid surface material
- bread baskets / boxes, trays and cutting boards made of walnut
- trays made of shell and melamine
- cruet stands and trays with suitable inserts
- food displays and etageres
- jam trays
- trays made of melamine and glass with 3 / 4 sockets for inserts
- vinegar / oil bottles
- wind lights, LED tealights and accessories

Room service / guestrooms

284

- storage / presentation boxes, roomservice trays and accessories, cutlery box "Solid"
- trays made of shell "Capiz"
- bowls and baskets made of pewter alloy "Reef"
- bridges and trays "Podia"
- coat rack "Kibu"

Cutlery

297

- "Mao"
- "Goa"

List of items in ascending order

301

Table of content

306

“Design by Zieher” - our motto for 12 years!

In the year 2006 we designed the first items ourselves and placed them on the market. Since that time developing and implementing exclusive design objects has been our calling. On this page we show a couple of the most important creations of the past years.

Design, innovation and quality are our mission!



2006



2008



2010

2007



2009



The Zieher Design History



2012

2014

2016

2011

2013

2015



"Solid", page 287



VAGANZA, page 202



"Eddy", page 209



"Cuspis", page 213



"Mercato", pages 104 / 105



"Lacuna", pages 214 / 215



"Donna", pages 142 / 143



"Donna", pages 142 / 143



NEWS 2017!

Etageres, pages 270 / 271



"Slope", page 259



"Connect!", page 254



Glass platters, page 183



"Cave", page 173



Buffet



"Skyline" - Manhattan-Feeling on the buffet



"Skyline", Zieher's buffet system, allows a maximum of flexibility for most exclusive buffet presentations. Different heights enable you to install big buffet platters on the one hand - on the other hand they can be stabilised by insertion into the corresponding serration. The square columns are made of highly-polished stainless steel and due to the standardised serration heights they can be combined with the "Squareline" (pages 13 to 17) and "Curve" series (pages 18 and 19).

The spectacular look that brings the silhouette of skyscrapers to mind, is available in a highly polished version and for an intensified effect also in golden and copper versions (page 9) as well as in black and white colouring (page 8). The optionally available Zieher LED-lights are a perfect addition to the system and come in 2 versions: cabled and rechargeable (pages 38 and 39). In combination with light-diffusing tubes (page 38), they provide a perfect illumination of the system in various colours.



The buffet platters are available on page 61.



Buffet platters made of grey glass are available on page 60, black glass trays and glass steps on pages 62 and 63.

DESIGN
by
ZIEHER

“Skyline” - the original!



"Skyline" - the original



The glass bowls item 5346 and 5308.26 are available on page 185.



The LED-lights, either as rechargeable or cable version, are available on pages 38 and 39.



acrylic glass tube

satined, white, removable lid for easy fitting of bowls etc., notch for cable for LED-light item 8104 (not included, please order separately)

item	Ø in cm	height in cm	PU
8122.10	12	10	3 tubes
8122.22	12	22	3 tubes
8122.34	12	34	3 tubes
8122.58	12	58	3 tubes



buffet stand "Skyline"

massive stainless steel 18/10, square, matt black (powder-coated), not dishwasher-safe

item	l x w x h in cm
8300.10	25x25x10.5
8300.22	25x25x22.5
8300.34	25x25x34.5
8300.58	32x32x58.5

buffet stand "Skyline"

massive stainless steel 18/10, square, white (powder-coated), not dishwasher-safe

item	l x w x h in cm
8305.10	25x25x10.5
8305.22	25x25x22.5
8305.34	25x25x34.5
8305.58	32x32x58.5

buffet stand "Skyline"

massive stainless steel 18/10, square, highly polished, dishwasher-safe, food-safe

item	l x w x h in cm
2177.10	25x25x10.5
2177.22	25x25x22.5
2177.34	25x25x34.5
2177.58	32x32x58.5



Refined stock items are available on page 80, more information about refining of stainless steel in the PVD process on page 312.

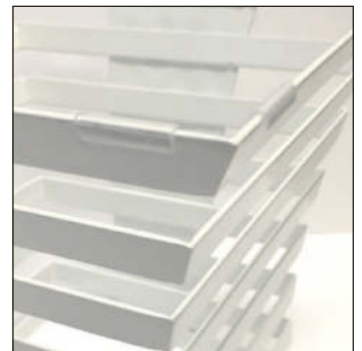

buffet stand "Skyline"

massive stainless steel 18/10, golden (PVD-coated), square, highly polished, dishwasher-safe, food-safe

item	l x w x h in cm
2177.10G	25x25x10.5
2177.22G	25x25x22.5
2177.34G	25x25x34.5
2177.58G	32x32x58.5

buffet stand "Skyline"

massive stainless steel 18/10, coppery (PVD-coated), square, highly polished, dishwasher-safe, food-safe

item	l x w x h in cm
2177.10C	25x25x10.5
2177.22C	25x25x22.5
2177.34C	25x25x34.5
2177.58C	32x32x58.5

silicone sleeve

transparent, slotted lengthwise, for buffet stands "Squareline" items 8081..., 8082..., 8084... and buffet stands "Skyline" items 2177..., 8300... and 8305... (prevents the slipping of buffet platters)

item	length in mm	PU
4684	20	10 pcs

The bowl "Sixth Sense" is available on page 82.



fruit/bread basket "Skyline"

massive stainless steel 18/10, square, highly polished, with bottom plate and 4 rubber feet

item	l x w x h in cm
2179.10	25x25x11.5
2179.22	25x25x23.5
2179.34	25x25x35.5



wine cooler

fibreglass natural, with raised bottom and notch for cable on the backside to place an LED-light under the cooler, to be used as an insert for bread basket "Skyline" item 2179.22 or buffet stand "Skyline" items 2177.22, 8300.22 and 8305.22

item	l x w x h in cm	content in l
8201	22x22x22	4.0



Spot colours upon request!



fruit/bread basket "Skyline"

massive stainless steel 18/10, square, highly polished, with bottom plate and 4 rubber feet

item	l x w x h in cm
2178.23	40x40x23.5

For the illumination of item 8202, we recommend the use of 2 - 3 LED-lights.



wine cooler

fibreglass natural, with raised bottom and notch for cable on the backside to place an LED-light below the cooler, to be used as an insert for bread basket "Skyline" item 2178.23

item	l x w x h in cm	content in l
8202	37x37x22	16.0

Please note: The bread baskets from the "Skyline" series have a closed base plate and rubber feet. They deviate in height from the buffet stands items 2177...





glass bottle

with swing top (PVC lid), height incl. swing top

item	Ø / height in cm	content in l	PU
5290.02	5.5 / 19	0.2	12 pcs

Also usesable for yoghurt cups!



transparent insert



insert for wine cooler item 8202 acrylic glass, with 9 holes, suitable for glass bottle with swing top item 5290.02 or for standard juice glasses/bottles up to a diameter of 5.8 cm

item	version	l x w in cm
8203.01	transparent look	31.4x31.4
8204.01	frosted look	31.4x31.4



“Skyline”

The inserts are available in two versions with frosted and transparent surface finish. They prevent the shifting and leaking of carafes and glasses in ice and keep the buffet constantly in good order.



decanter

glass, transparent

item	Ø in cm	height in cm	content in l
5352	9	31	1.0

frosted insert



insert for wine cooler item 8202 acrylic glass, with 4 holes, suitable for decanters or bottles up to a diameter of 10.5 cm

item	version	l x w in cm
8203.02	transparent look	33.5x33.5
8204.02	frosted look	33.5x33.5



Cabled and rechargeable, battery-powered LED-lights are available on pages 38 and 39.

"Skyline" made by Zieher - Compare the original to copies of inferior quality!

Reasons to stick with the original:

- Different versions: polished, golden and copper, matt black and white
- Highest Zieher quality and perfect accuracy in manufacturing
- Compatibility with other Zieher items
- 100 % fitting illumination
- Massive stainless steel 18/10
- Designed by Zieher in 2009



"Squareline"



The "Skyline" buffet system allows a maximum of flexibility for most exclusive buffet presentations.

Due to the same serration heights, the "Skyline" system is combinable with our "Squareline" system (pages 13 to 17) and "Curve" (pages 18 and 19). The different adaptors of the "Squareline" system may equally be used with the "Skyline" stands (exception: columns with 58 cm height).

Please note: If the walnut adaptor (item 4736) is combined with "Skyline", the display cannot be illuminated, due to constructional reasons.

Some exemplary displays can be seen here:



12 "Skyline" black, connector pieces acrylic glass satined (page 16), platters grey glass (page 60), acrylic glass tubes (page 8), rechargeable LED-lights (page 39).

"Skyline" white, walnut connector piece (page 16), walnut tray (page 112).

"Skyline" highly polished, connector pieces acrylic glass black (page 16), platters black glass (page 58), acrylic glass tubes (page 8), rechargeable LED-lights (page 39).

"Squareline", the buffet system with 1000 faces!



"Squareline" white, acrylic connector pieces black (page 16), glass platters black (page 58), glass steps black and glass trays black (page 62).

Our classic "Skyline" has been changed and advanced to become "Squareline", which now offers several new features apart from its pure design.

The stainless steel displays are available in two heights. Five versions, highly polished, golden, copper, matt black and white, grant the columns completely different effects! The "Squareline" towers can be stacked on top of each other by using connector pieces that are available in three different versions. A 90° rotated arrangement of the stands increases the creative leeway tremendously and permits a buffet set-up at an angle.

Besides the technical aspect, the connector pieces are mainly a decorative element. They are available in glossy black as well as in satined, light-diffusing acrylic. The third version is handmade from solid walnut in best quality. In connection with the various displays and buffet platters uncountable possibilities for the creation of a buffet arise.

Optionally "Squareline" offers the possibility of a 100 % integration of our "Lightning Buffet" – the full height of the columns will be illuminated from the inside. When using the satined connector pieces, their light-diffusing effect even enhances the spectacular sight. The system is based on the buffet classic "Skyline" (pages 6 to 12), both in construction and in form. So both systems can be combined quite easily.

Just let your imagination run wild!



"Squareline" polished, acrylic connector pieces satined (page 16), platters transparent glass (page 57), buffet platters (page 76), glass steps transparent (page 63), „Lightning Buffet“ tubes (page 38), rechargeable LED-lights (page 39).



"Squareline" black, acrylic connector pieces satined (page 16), glass platters grey (page 60), "Lightning Buffet" tubes (page 38), rechargeable LED-lights (page 39).

"Squareline" copper, acrylic connector pieces satined (page 16), glass platters white (page 59), "Lightning Buffet" tubes (page 38), rechargeable LED-lights (page 39).

DESIGN
by
ZEHER

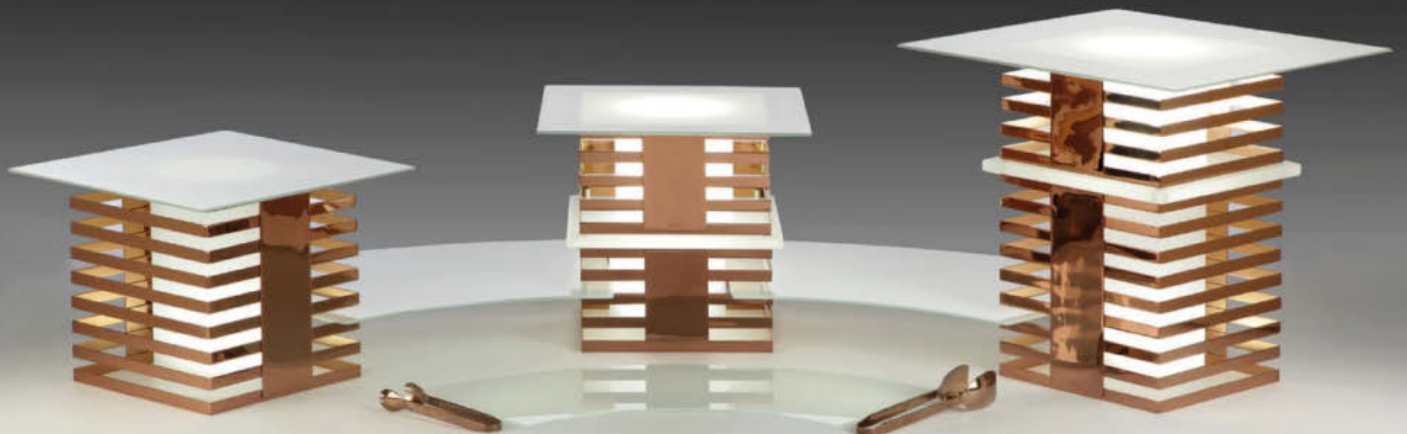

No matter whether it is classic design in stainless steel with wood, golden and copper, or the highly modern design in matt black and white with stunning lighting – "Squareline" will adapt to every atmosphere and will give your guests lasting impressions!

"Squareline"



"Squareline" white, acrylic connector pieces black (page 16), glass platters black (page 58), glass steps black and glass trays black (page 62).



"Squareline" polished, connector pieces walnut (page 16), glass platters milky (page 56), trays "Solid" walnut (page 112), glass steps transparent (page 63).



"Squareline" black, acrylic connector pieces black (page 16), glass platters black (page 58), glass steps black (page 62).

"Squareline"



buffet stand "Squareline"

massive stainless steel 18/10, square, highly polished, dishwasher-safe, food-safe

item	l x w x h in cm
8081.13	24x24x13.5
8081.25	24x24x25.5



buffet stand "Squareline"

massive stainless steel 18/10, golden (PVD-coated), square, highly polished, dishwasher-safe, food-safe

item	l x w x h in cm
8081.13G	24x24x13.5
8081.25G	24x24x25.5

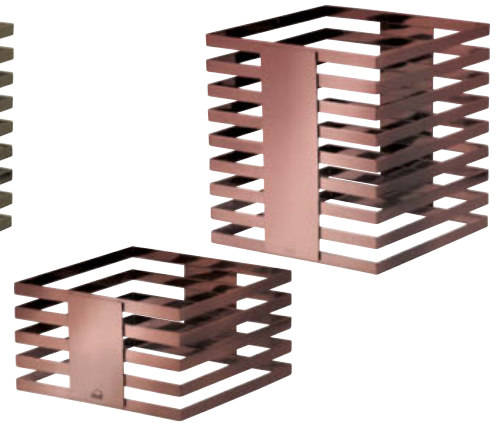

buffet stand "Squareline"

massive stainless steel 18/10, copper (PVD-coated), square, highly polished, dishwasher-safe, food-safe

item	l x w x h in cm
8081.13C	24x24x13.5
8081.25C	24x24x25.5

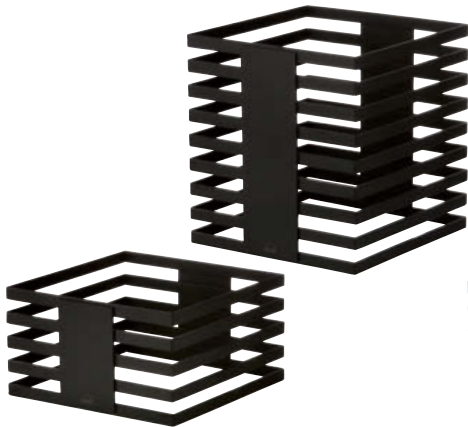

buffet stand "Squareline"

massive stainless steel 18/10, square, matt black (powder-coated), not dishwasher-safe

item	l x w x h in cm
8082.13	24x24x13.5
8082.25	24x24x25.5



buffet stand "Squareline"

massive stainless steel 18/10, square, white (powder-coated), not dishwasher-safe

item	l x w x h in cm
8084.13	24x24x13.5
8084.25	24x24x25.5



silicone sleeve

transparent, slotted lengthwise, for buffet stands "Squareline" items 8081..., 8082..., 8084... and buffet stands "Skyline" items 2177..., 8300... and 8305... (prevents the slipping of buffet platters)

item	length in mm	PU
4684	20	10 pcs



acrylic connector "Squareline"

clear satined (translucent), with 4 stainless steel pins and 4 holes for cable run

item	l x w x h in cm
8083.01	27x27x3.5

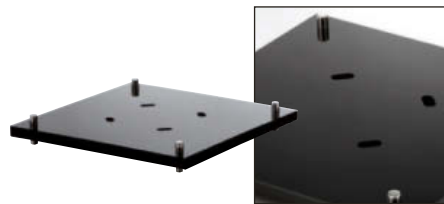

acrylic connector "Squareline"

black, glossy, with 4 stainless steel pins and 4 holes for cable run

item	l x w x h in cm
8083.02	27x27x3.5



walnut connector "Squareline"

food-safe sealed, not dishwasher-safe, with 4 holes for cable run

item	l x w x h in cm
4736	27x27x7

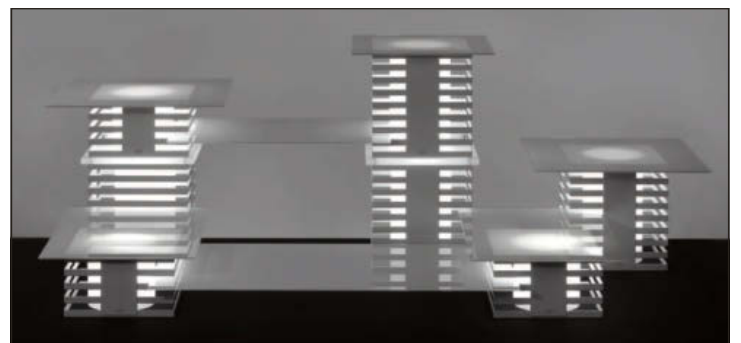
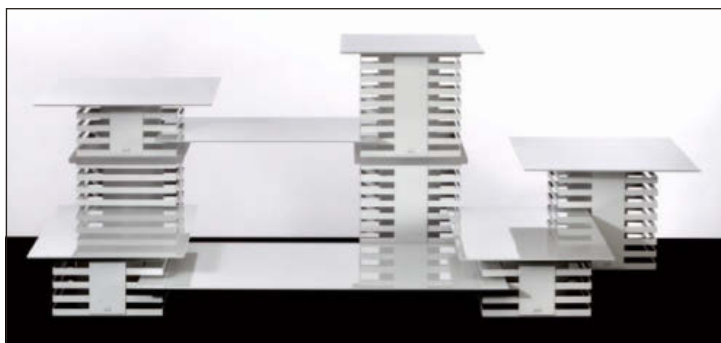

"Squareline" white, acrylic connector pieces satined, platters white glass (page 59), "Lightning Buffet" tubes (page 38), rechargeable LED-lights (page 39).

"Squareline"



The rechargeable LED-light (item 8150, optionally available, page 39) offers numerous fixedly installed colours as well as special programs like colour gradient and flickering-candle-effect. The compatible remote control (item 8151) allows the synchronization of up to 20 LED-lights at the same time and enables the change of the complete buffet-colouring by just pressing one button!

Alternatively and especially for fixed buffet installations we recommend the use of the Zieher LED-light with cable (item 8104, page 38). With this item, 5 lighting colours can be set by using stick-on colour-filters.

The connector pieces feature slots for the cables, so that the cables can be laid invisibly through the columns of the "Lightning Buffet". To do this, the detachable lids of the acrylic tubes have to be removed. If cabled LED-lights are used, it is recommended to lay down all components of a "Squareline"-tower next to each other on the table to facilitate the installation of the cables.



rechargeable LED-light,
page 39



cabled LED-light, page 38



acrylic tubes,
items 8120..., page 38

Please note: To illuminate the system you will need one LED-light and one acrylic column in the fitting size (12 resp. 24 cm) for each "Squareline" stand. The acrylic columns are available in sets of 3 pieces (items 8120...) and can be found on page 38, the information on our LED-lights can be found on pages 38 and 39.





DESIGN
by
ZEHER

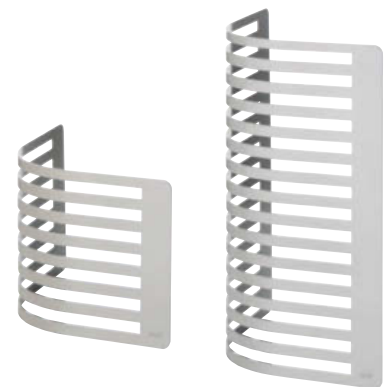

buffet stand "Curve"

galvanised steel, 3 mm thick, white (powder-coated), not dishwasher-safe

item	l x w x h in cm	PU
8311.22	27x27x22.5	2 pcs
8311.46	27x27x46.5	2 pcs

"Curve"

– flexibility with a concept

"Curve" is made of 3 mm strong galvanised steel with a high grade powder coating. This guarantees great stability and corrosion-resistance. The colouring in matt black or white as well as the gaps between the bars were expressly chosen by the Milanese designer Itamar Harari to make the raisers completely compatible with the systems "Skyline" (pages 6 to 12) and "Squareline" (pages 13 to 17). The attractively priced "Curve" is therefore not only suitable as a starter version but also as an optimal extension of existing systems.



During the development of "Curve" special attention was given to the mobile usage. Thus all components can be stored in an extremely space-saving way. Simple and swift to install, "Curve" is the perfect equipment for outdoor areas, events and catering.

Design: Itamar Harari

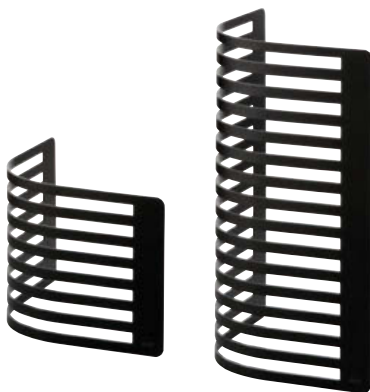

buffet stand "Curve"

galvanised steel, 3 mm thick, matt black (powder-coated), not dishwasher-safe

item	l x w x h in cm	PU
8310.22	27x27x22.5	2 pcs
8310.46	27x27x46.5	2 pcs



"Stablo" - filigree versatility!

The buffet stands made of solid, brightly polished stainless steel impress by their high-quality workmanship and delicate appearance. Bowls and dishes almost appear hovering while slip-proof caps on the feet ensure safe support.

The height of the two large stands (items 8016 and 8016.01) is adjustable via extensions from 80 cm to 120 cm. Massive and bulky buffet tables become virtually redundant.



The buffet stand with its integrated ring (item 8016.01), allows for the presentation of plates and platters (max. dia. 21 cm on the lower level), but also for the insertion of two extravagant wine coolers made of borosilicate glass or resin. The coolers, positioned at an angle, may also be used with the "Stablo" stands in the sizes M and L.

The shape of the cooler corresponds to the already well-known Zieher glass cloches (pages 189 to 193), robust resin or thicker quality borosilicate glass ensures the necessary stability! Due to its shape, any condensing water on the outside is drained off to the bottom tip. Dripping water can easily be caught by placing a small bowl on the floor or the buffet table. The integration of the optionally available Zieher rechargeable LED-lights creates breathtaking visual effects and puts champagne but also iced food in the limelight!



A three-staged buffet etagere is offering a lot of space for all kinds of food. It can be equipped with numerous trays and plates of the Zieher range. Anti-slip caps avoid annoying noise and ensure the safe grip of the trays.

Design: Uwe Kopp, Jörg Stricker

The etagere with suitable trays is available on pages 24 and 25.

“Stablo”



"Stablo"

DESIGN
by
ZEHER



Buffet bowls in many variations and materials are available on pages 64 to 95.



buffet stand "Stablo"

massive stainless steel 18/10, polished, with 6 anti-slip rubber caps, 8 mm thick

item	Ø top/bottom in cm	height in cm	PU
8014.13	15/20.5	13.5	3 pcs
8014.20	15/23	20	3 pcs

Suitable for buffet stands "Stablo" M, L



buffet stand "Stablo" S, M, L

massive stainless steel 18/10, polished, with 6 anti-slip rubber caps, 10 mm thick

item	Ø top/bottom in cm	height in cm	PU
8015.20	22/30	20 / S	3 pcs
8015.30	22/35	30 / M	3 pcs
8015.40	22/39	40 / L	3 pcs



buffet stand "Stablo" XL

massive stainless steel 18/10, polished, with 6 anti-slip rubber caps, 3 of which are separately packed (to clip onto the bottom part while not using the extensions items 8017..., please order the extensions separately), 12 mm thick

item	Ø top/bottom in cm	height in cm	PU
8016	26.5/38	40	3 pcs



GIFT BOX

Including 60 cm extensions.

illuminated wine cooler with stand "Stablo"

Set consists of:

wine cooler made of borosilicate glass
rechargeable LED-light incl. charging device, remote control and silicone ring to place the light on
stand "Stablo" XL-ring made of massive stainless steel 18/10, polished, with anti-slip rubber caps, incl. extension set with 60 cm length
1 set in black gift box

item	total height in cm	PU
8070.01PB	52/112	1 set (7 parts)



extension "Stablo"

massive stainless steel 18/10, polished, with anti-slip rubber caps, for one buffet stand "Stablo" item 8016 or 8016.01 (not suitable for items 8014... and 8015...), 12 mm thick

item	length in cm	PU
8017.40	40	1 set (3 parts)
8017.60	60	1 set (3 parts)
8017.80	80	1 set (3 parts)

Extension for buffet stand "Stablo" XL / XL ring

8017.40: for a total height of 80 cm
8017.60: for a total height of 100 cm
8017.80: for a total height of 120 cm

Please note:

For one buffet stand "Stablo" XL item 8016 or "Stablo" XL ring item 8016.01 only one set of extensions is required.



The buffet displays "Neo" are available on pages 32 and 33.

The rechargeable LED-light item 8150 and suitable accessories are available on page 39.



Instruction sheet with detailed description:
<http://zieher.com/fileadmin/downloads/Anleitungen/InstructionSheet8150.pdf>



wine cooler/cloche

resin, anthracite, matt finish, translucent, not dishwasher-safe

item	Ø in cm	height in cm
7010.26	26	approx. 43



By positioning the cooler at an angle it is also suitable for buffet stands "Stablo" M and L.



Positioning of ring and light



wine cooler

borosilicate glass, transparent, handblown, handmade, reinforced version, for „Stablo“ M, L items 8015.30 and 8015.40 (by positioning the cooler at an angle) and „Stablo“ XL ring item 8016.01

item	Ø in cm	height in cm
4881.26	26	41-44



Also available separately!

buffet stand "Stablo" XL-ring

massive stainless steel 18/10, polished, with ring-opening (Ø 12 cm inside) for wine cooler items 4881.26 and 7010.26, with 6 anti-slip rubber caps, 3 of which are separately packed (to clip onto the bottom part while not using the extensions items 8017..., please order the extensions separately), 12 mm thick

item	Ø top/bottom in cm	height in cm	PU
8016.01	22.5/37	40	3 pcs



ring "SelectionA."

silicone, Ø 8.3 cm

item	colour	PU
4681.S	black	6 pcs
4681.W	white	6 pcs



The buffet etagere item 2193.02 in hammered look is available on page 97.



base tray "Modul"

melamine, black, surface matt, food-safe, dishwasher-safe, not suitable for microwave and combi steam oven

item	l x w x h in cm	PU
4582	72.5x28x1.8	2 pcs



base tray "Modul"

walnut, food-safe sealed, stackable, not dishwasher-safe

item	l x w x h in cm
4722	70x25.5x3.1



buffet platter

special hardened safety glass, rounded edges, polished rim, dishwasher-safe, rubber feet included (adhesive), underside scratch-proof, 4 mm thick

item	version	l x w in cm
1668.08	black glass	80x20
1670.08	white glass	80x20



buffet platter

laminated plastic, rectangular, black intermediate ply, deburred edges, rounded corners, break-proof, scratch-proof, dishwasher-safe, antistatic, 8 mm thick

item	version	l x w in cm
8002.08	old varnish white	80x21
8003.08	ruined look	80x21
8006.08	dark grey	80x21



buffet platter

hardened glass, rectangular, edges polished and deburred, 10 mm thick

item	version	l x w in cm
5243	transparent glass	80x21
5243.M	satined glass	80x21
5243.B	dark grey glass	80x21



buffet platter

hardened glass, grey transparent, rectangular, irregularly coloured in a cloudy look, underside structured, dishwasher-safe, scratch-proof

item	l x w in cm	thickness in mm
8008.08	80x21	8

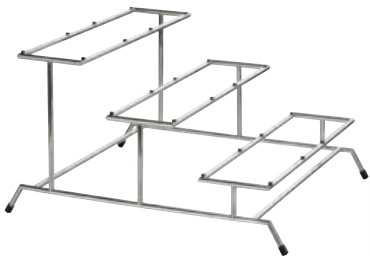

buffet etagere "Stablo"

massive stainless steel 18/10, with 4 anti-slip rubber caps and 24 rubber pads (for anti-slip placing of the trays), support for trays: 46.5 x 13 cm, 10 mm thick

item	l x w x h in cm
8013	46.5x54.5x30



tray with feet

massive stainless steel 18/10, rectangular, hammered finish, six times polished, for buffet etagere items 8013, 2193 and 2193.02

item	l x w x h in cm
2193.01	62x18x5



glass tray

satined, rectangular

item	l x w x h in cm
5160.31	31x21x3.5
5160.62	62x21x3.5



glass tray

dark grey, rectangular

item	l x w x h in cm
5161.31	31x21x3.5
5161.62	62x21x3.5





The glass stands with a suitable cloche are available on page 194, the miniatures on pages 211 to 244.

The buffet bridges and trays of the "Podia" series offer several advantages!

They are light but robust, flexibly usable and can be stored in a space-saving way.

With its use as a display on the buffet, during coffee break or as a platter for fruit or little somethings in the hotel room - "Podia" offers multiple possibilities for use and flexible handling.

Three trays in GN formats (1/2, 1/3 and 2/8) are especially suitable for different miniatures made of porcelain and glass; anti-slip silicone coasters in different styles (page 210) guarantee a good grip during service.



All parts of this series consist of form-glued authentic wood veneer, the bridges are available in two types of wood.

The light version harmonizes very well with mundane but also with rustic-style furnishing, the version with the black-brown stripes appears exotic and modern.

More items for the room service/ guestrooms are available on pages 285 to 296.



buffet bridge "Podia", triple pack
genuine wood veneer, light colouring (similar to oak), not dishwasher-safe

item	w x d x h in cm	PU
8731	30x20x6 (1st bridge)	1 set
	36x20x9 (2nd bridge)	
	42.5x20x12 (3rd bridge)	

Please note the care instructions!



GN tray "Podia"

genuine wood veneer, dark (black-brown striped),
not dishwasher-safe

item	l x w in cm	GN	PU
8732.01	32.5x13.2	2/8	6 pcs
8732.02	32.5x17.6	1/3	6 pcs
8732.03	32.5x26.5	1/2	6 pcs



buffet bridge "Podia", triple pack

genuine wood veneer, dark (black-brown striped),
not dishwasher-safe

item	w x d x h in cm	PU
8730	30x20x6 (1st bridge)	1 set
	36x20x9 (2nd bridge)	
	42.5x20x12 (3rd bridge)	



Not dishwasher-safe, do not immerse in water!

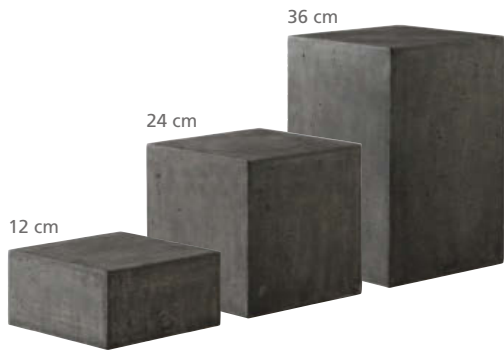

"Konkret!" (from page 46 on)

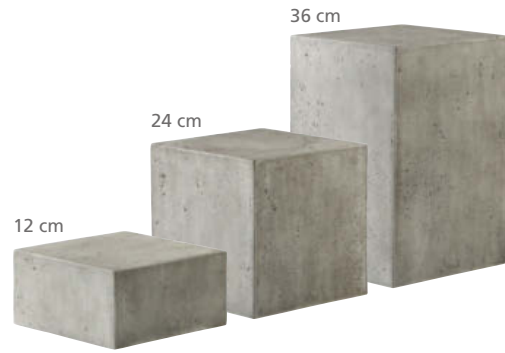

"Konkret!" (from page 46 on)

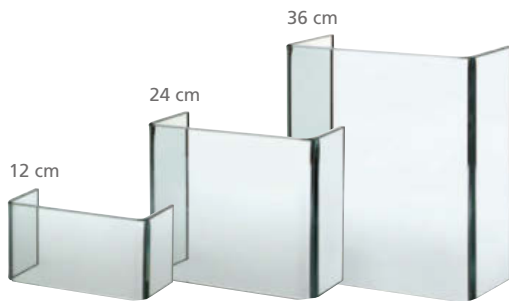
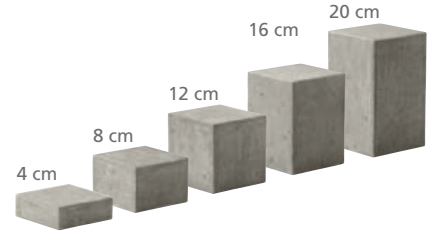
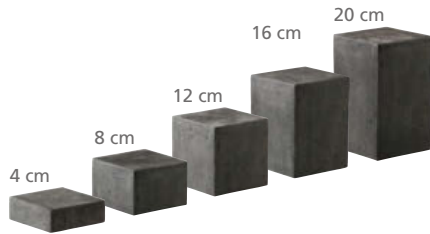

"U-Turn" (page 40)



"Solid" (page 41)

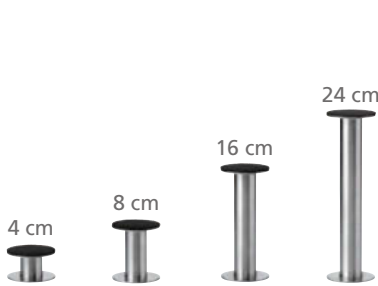

"Basic" (from page 50 on)

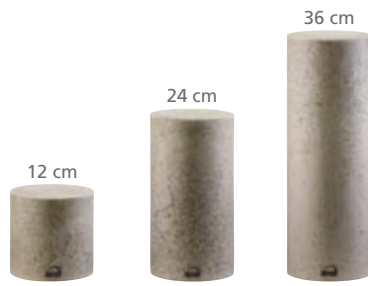

"Antique" (page 35)



"Lightning Buffet" (from page 36 on)



"Basic" + "Konkret!"

The "Zieher-System"

Zieher offers innumerable possibilities to present food optically appealing and highly flexible. When developing new buffet products it is most important for Zieher to guarantee compatibility among the individual systems. The "Zieher-System" with its different heights of 12, 24 and 36 cm or 8, 16, and 24 cm leads to a perfect composition of different presentation levels on the buffet, thus offering more flexibility in the arrangement of a buffet. A wide range of buffet platters and trays of hardened glass, natural slate and laminated plastic in various styles are available on pages 52 to 63.

Thanks to the boundless possibilities, varying materials and designs, every buffet can easily be adapted to any accommodation. The system becomes part of the whole interior and assimilates harmonically into any ambiance.



"Basic" + "V12" - Carbon



24 / 16 / 8 cm

"Classy" (from page 30 on)

"Pearl" (page 34)

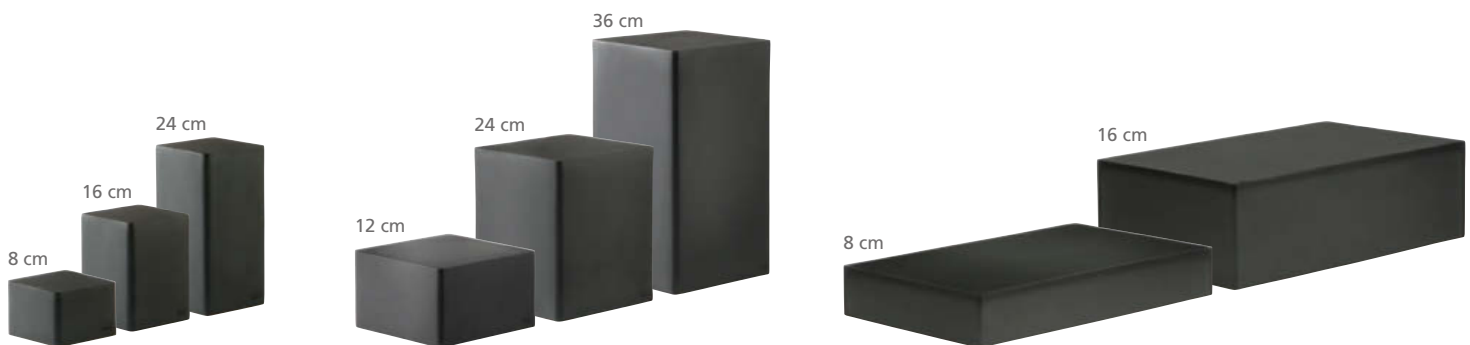

"Neo" (from page 32 on)

"Neo" (from page 32 on)

"Neo" (from page 32 on)

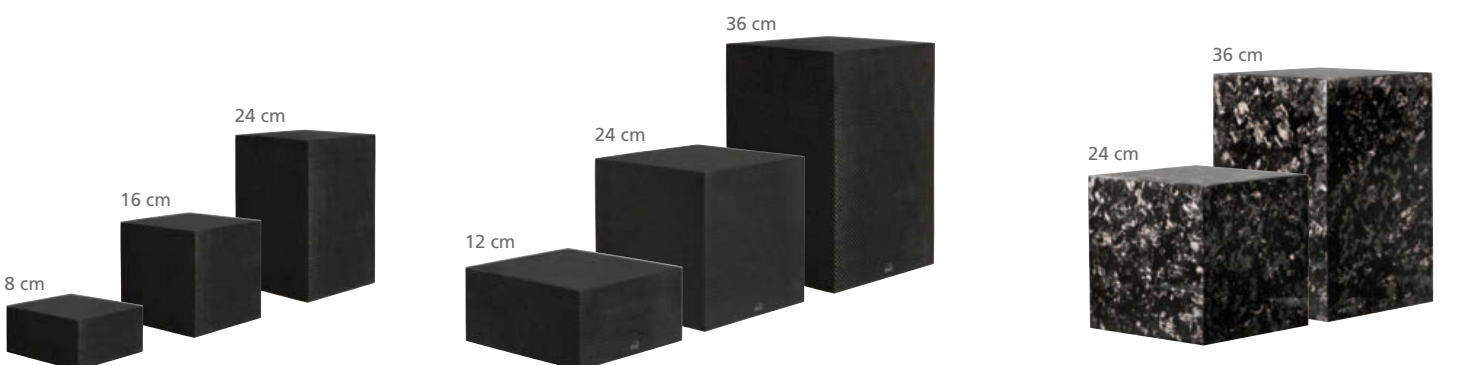

"V12" - Carbon (from page 42 on)

"V12" - Carbon (from page 42 on)

"Carbon 4.0" (from page 43 on)

The buffet displays "Classy" are made of translucent material and impress by their fascinating texture that is reminiscent of Italian marble or alabaster. The precise workmanship of the cubes as well as the silk-matt surface increase the fancy impression even more.

"Classy" is available in the Zieher system heights of 8, 16 and 24 cm and can therefore be combined in various ways. The open bottom side of the large displays allows an effective illumination by the optionally available LED-lights. With their different light colours, the LED-lights emphasise the appealing look and the interesting marbling of the material.

The small cube has no open underside and thus cannot be illuminated. The advantage of this construction lies in its high functionality. Its dimensions of 24 cm x 16 cm x 8 cm enable a positioning in 3 heights - a clever supplement to the squarish displays.



The baskets of the "Reef" series are available on pages 66 and 67.



It is possible to stage "Classy" with or without lighting, strikingly eye-catching or quite decently. Whether unobtrusive and modern or playful and opulent – "Classy" fits perfectly into any surrounding!



Closed on all sides, cannot be illuminated.



buffet display "Classy"

resin, white, alabaster look, closed on all sides, can be used in any position, not dishwasher-safe

item	l x w x h in cm
8231	24x16x8



The LED-lights are available on pages 38 and 39.



Notch for cable
for LED-light item 8104



buffet display “Classy”

resin, white, translucent, alabaster look, bottom side open, notch for cable on back side, not dishwasher-safe

item	l x w x h in cm
8230.08	38x38x8
8230.16	38x38x16
8230.24	38x38x24



"Neo"



The optionally available LED-lights (pages 38 and 39) – either rechargeable or cabled – are the ideal completion to put "Neo" into perspective. By using the waterproof (up to 1 m) and remote-controlled rechargeable LED-light it is also possible to illuminate the ice in the iceboxes from below – a really fascinating view. A big choice of LED-light colours guarantees spectacular effects!



The glass platters of the series "Ice" are available on page 177.

The trays and bowls of the series "Artisan" are available on pages 78 and 79.



buffet display/icebox "Neo"

resin, anthracite, matt finish, translucent, bottom side open, notch for cable on back side, not dishwasher-safe

item	l x w x h in cm
7005.08	53x32.5x8

buffet display/icebox "Neo"

resin, anthracite, matt finish, translucent, bottom side open, notch for cable on back side, not dishwasher-safe

item	l x w x h in cm
7005.16	53x32.5x16



The buffet system “Neo” is made of anthracite coloured resin. The matt surfaces and softly rounded edges of these translucent cubes appear unobtrusive and modern. “Neo” unfolds its true potential when the columns are effectively illuminated. A wine cooler resp. cloche made of the same material (page 23) is a beautiful complement and blends harmonically into the system.



Notch for cable
for LED-light
item 8104



buffet display “Neo”

resin, anthracite, matt finish, translucent, bottom side open, notch for cable on back side, not dishwasher-safe

item	l x w x h in cm	PU
7000.08	12x12x8	2 pcs
7000.16	12x12x16	2 pcs
7000.24	12x12x24	2 pcs

buffet display “Neo”

resin, anthracite, matt finish, translucent, bottom side open, notch for cable on back side, not dishwasher-safe

item	l x w x h in cm
7001.12	20x20x12
7001.24	20x20x24
7001.36	20x20x36

Spot colours upon request.

"Pearl"



The unique look of the "Pearl" buffet displays is achieved by the processing of high-grade shell imitations molded into polyresin. This is why each cube is an individual item and might vary in its form and structure. The displays are the outcome of highly sophisticated handcraft. Each piece is sanded until it becomes extremely thin and then customized to the desired shape. Thereafter, the single pieces are arranged into an elaborate herringbone pattern. In order to guarantee the necessary stability of the displays, the inside is made of fibreglass and the outside of high-gloss artificial resin. Whether with or without illumination, the pearly coloured displays are outstanding in every light!



For an intense and all-over illumination we recommend the usage of 3 LED-lights per display. The lights are available on pages 38 and 39.



DESIGN
by
ZEHER



buffet display "Pearl"

high-quality shell imitation, mother-of-pearl effect, washable, bottom side open, hollow inside, with 4 resin feet for easy placing of cables for LED-light item 8104 (please order separately)

item	l x w x h in cm
8220.08	38x38x8
8220.16	38x38x16
8220.24	38x38x24



Notch for cable for LED-light item 8104

Please note: Due to the density of the material, the glow may be limited.



buffet stand "Antique"

polyresin sandstone mixture, sandy colour, hollow inside, notch for cable on back side

item	Ø in cm	height in cm
8011.12	12.5	12
8011.24	12.5	24
8011.36	12.5	36



"Stablo" pages 21 to 25



"Squareline" pages 13 to 17



"Skyline" pages 6 to 12



Caviar set, page 94



"Art de Buffet" pages 81 to 99



"Squareline" pages 13 to 17



"Neo" pages 32 and 33



"Konkret!" pages 46 to 49

"Lightning Buffet"



Bringing light into the darkness!

The illuminated buffet stands in connection with platters made of natural slate, laminated plastic or glass (pages 54 to 65) make every buffet shine in a radiant new light.

The innovative LED technology does not radiate any heat and is powered by a harmless voltage. It is characterized by its longevity and its low power consumption. The standard light of the cabled LED is white, but thanks to the coloured plastic covers, the colour scale is enlarged to contain red, yellow, green and blue (page 38).

Alternatively there is a rechargeable LED-light with several different functions available. Besides a fixed colour range and special programs, its particular feature is a remote control that enables the changing of colours and programs while in use. For a detailed description of this LED-light and its functions please check out page 39.

The columns made of satined acrylic (page 38) are available in seven sizes and feature a removable cover to enable the insertion of round bowls.





The height of the columns items 8122... has been adjusted especially for the illumination of the "Skyline" buffet system. The lids of all acrylic glass tubes are removable. Therefore the tubes can also function as supports for plates, bowls, etc.



acrylic glass tube

satined, white, removable lid for easy fitting of bowls etc., notch for cable for LED-light item 8104 (not included, please order separately)

item	Ø in cm	height in cm	PU
8122.10	12	10	3 tubes
8122.22	12	22	3 tubes
8122.34	12	34	3 tubes
8122.58	12	58	3 tubes



acrylic glass tube

satined, white, removable lid for easy fitting of bowls etc., notch for cable for LED-light item 8104 (not included in delivery, please order separately)

item	Ø in cm	height in cm	PU
8120.01	15	12	3 tubes
8120.02	15	24	3 tubes
8120.03	15	36	3 tubes

LED-light with cable, item 8104...



For permanently installed buffets which are not dismantled on a daily basis, it is recommended to use the LED-light with cable item 8104.

The standard light is white; the alternative colours blue, yellow, green and red can be chosen by using the precisely fitting plastic covers items 8105... (available as accessories).

A set consists of 3 lights and the matching power supply, which can be fitted with a total of 6 lights. All cables are white and the power cable of the light has a length of 3 metres, which is enough to stow away adapter and power supply safely and invisibly under the buffet table.



LED-light

white light, set of 3 LED-lights including power supply (cable), sixfold junction for up to 6 lights, 100-240 V, 50/60 Hz, Ø 9.7 cm, height: 2 cm

item	power plug
8104	Europe
8104.UK	UK
8104.USA	USA



white blue yellow green red

Please note: The luminosity depends on the spatial realities; the actual colouring may deviate from the colours shown in the pictures!



colour cover

plastic, for LED-light items 8104..., Ø 10 cm

item	colour	PU
8105.01	blue	3 pcs
8105.02	yellow	3 pcs
8105.03	green	3 pcs
8105.04	red	3 pcs

Rechargeable LED-light with radio remote control:



The compact LED-light is controlled by remote control, which allows for a more flexible use of the Zieher "Lightning Buffet" and renders it independent from any power supply and spatial requirement.

This creates a lot of new possibilities for the buffet set-up: out in the open, next to the pool or in the middle of the room – without any troublesome cables and controllers that might get into the guests' or the personnel's way.

The necessary radio remote control item 8151 (to be ordered separately) rounds off the whole system in regard to function and handling and allows to choose the colouring within a range of up to 15 m without dismantling the buffet first. Due to many different colours and special programs, the buffet will fit into every kind of atmosphere.

The lighting colour for the complete buffet can be changed by pressing only one button.

- 7 fixed colours and 3 special programs, manageable via remote control (white, green, red, blue, yellow, violet, turquoise, flickering-candle-effect, colour change, colour gradient)
- 3 different brightness-settings selectable (100 % - 70 % - 50 %, only adjustable directly on the LED-light)
- Fixedly integrated high-end batteries guarantee a running-time of up to 20 hrs (at the lowest brightness-setting)
- LED-light waterproof up to a depth of 1 m
- Remote control (to be ordered separately) controls up to 20 LED-lights simultaneously / range up to 15 m
- Charging device can be mounted on a wall and features a space-saving cable spool



**Experience the "Lightning Buffet" – no matter where - you will be excited!
A choice of applications for the Zieher LED-light can be found on page 36.**



rechargeable LED-light

remote-controlled, 3 different degrees of brightness (only selectable on the light directly), 7 fixed colours (white, green, red, blue, yellow, violet, turquoise) and additionally: candle flickering, colour gradient and colour change (only selectable by remote control item 8151, please order separately).

item	Ø in cm	height in cm
8150	9.5	3



remote control

for rechargeable LED-light item 8150, white with grey cord

item	l x w x h in cm
8151	8.5x5.2x2.8



50 %



70 %



100 %



brightness-setting at the light



cable spool on charging station



recharging control light

Please note: The luminosity depends on the spatial realities; the actual colouring may deviate from the colours shown in the pictures!



charging device for rechargeable LED-light

white, with handy cable spool (1.5 m of cable), wall fixing possible, 3 anti-slip rubberfeet, Ø 13 cm, 2 cm high

item	power plug
8152.EU	Europe
8152.UK	UK
8152.US	USA



white



green



red



blue



yellow



violet



turquoise



The entire instruction sheet with a detailed description of all functions is available at <http://zieher.com/fileadmin/downloads/Anleitungen/InstructionSheet8150.pdf>

"U-Turn"



buffet stand "U-Turn"

transparent glass, polished and deburred edges

item	l x w x h in cm	thickness in mm	PU
5261.01	24x12x10	8	2 pcs
5261.02	28x24x12	10	2 pcs
5261.03	32x36x14	10	2 pcs

"U-Turn" is applicable as a simple buffet-bridge. By arranging the buffet-bridges one obtains unobtrusive elevations which are compatible with innumerable other products by Zieher, because of their sizes fitting into the Zieher system (12, 24 and 36 cm). More information can be found on pages 28 and 29.



The buffet displays "Konkret!" are available on page 48.



The buffet displays of the "Solid" series are made of solid walnut, like all the other items of this series. They may be used as containers for cutlery or French bread, but they are particularly suitable for the elevation of the "Modul" walnut trays (page 132) or other buffet platters.

The filigree finger joints at the corners testify to precise craftsmanship of the highest quality and guarantee perfect stability!

The displays made of solid wood are visually appealing and fit perfectly into the existing buffet systems "Solid" and "Mercato" (pages 104 to 115).



The walnut trays of the "Modul" series are available on page 132.

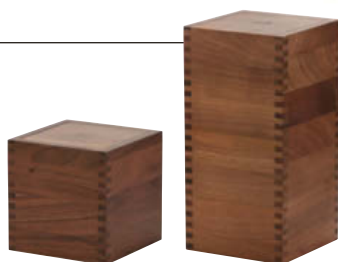

buffet display "Solid"

walnut, food-safe sealed, not dishwasher-safe, bottom side open, can be used as a stand or as a container

item	l x w x h in cm	PU
4767.12	12x12x12	2 pcs
4767.24	12x12x24	2 pcs

Please note the care instructions: not dishwasher-safe, do not immerse in water!

"V12" - Carbon



"V12" combines modern and reduced forms with the precious material carbon. The elegant and three-dimensional look of the carbon fibre paired with maximum stability - "V12" adds high-tech to the buffet!

In connection with the huge Zieher assortment of buffet platters, "V12" provides a maximum in flexibility and best usage of buffet surfaces. Six different sizes of the "V12" displays offer a lot of possibilities for the individual composition of your buffet.

The standardised height classification of the carbon buffet displays of 12, 24 and 36 cm resp. 8, 16 and 24 cm permits an easy and simple combination with other Zieher systems. For an overview please consult pages 28 and 29.

The buffet stands "Basic" are available on page 50, the cloches on pages 187 to 195.





"Carbon 4.0" upgrades that innovative material made of carbon fibre to a new level!

Contrary to "V12", which contains a woven carbon fabric, these displays consist of fibre chips that are pressure-grouted and embedded in synthetic resin. The result is a completely new look of the classic carbon material.

Depending on the incidence of light, the displays sparkle in dark and light shades, the depth effect and brilliance of the high gloss surface intensifies this effect enormously.

This completely new kind of carbon fibre material is currently only used for the interior design of a handful of selected sports cars. This fact emphasizes the exclusivity of the Zieher buffet displays!



"Carbon 4.0"



"Carbon 4.0"



"V12" - Carbon



buffet display "Carbon 4.0"

carbon fibre (chips), black, high-gloss, bottom side closed, splashproof, not dishwasher-safe

item	l x w x h in cm
8207.24	24x24x24
8207.36	24x24x36

buffet display "V12"

carbon fibre (fabric), black, high-gloss, bottom side closed, splashproof, not dishwasher-safe

item	l x w x h in cm
8206.08	20x20x8
8206.16	20x20x16
8206.24	20x20x24

buffet display "V12"

carbon fibre (fabric), black, high-gloss, bottom side closed, splashproof, not dishwasher-safe

item	l x w x h in cm
8205.12	24x24x12
8205.24	24x24x24
8205.36	24x24x36

"V12" - Carbon



"Mercato"



The buffet system "Mercato" is available on page 104.

"Solid"



The bread buffet "Solid" is available on pages 106 to 111.

Storage and transportation trolley

We are happy to offer you an individual solution for the transportation and storage of your miscellaneous items. Please ask us!



“Konkret!”



The XXL bowl “Konkret!” is available on page 49.



The displays consist of a mixture of fibreglass and stone and therefore offer the deceptively genuine optics of concrete combined with low weight and high stability which greatly facilitates handling. The puristic flair of that system will be intensified by using glass plates. Those and other variations made of laminated plastic and slate are available on pages 52 to 63.





“Konkret!” - Distinct design for highest flexibility!

Plain lines, neutral shapes and two different colour variations put your food presentation into focus and offer a maximum of flexibility while at the same time using the available space at your buffet most effectively. Maximum reduced shapes in combination with the rough look of concrete – “Konkret!” blends in particularly well with modern architecture. “Less is more” is the motto!

The well-known light grey version has been supplemented by a dark grey version. Both variants of the displays are available in eight sizes.

A real eye-catcher is the double-walled XXL bowl in dark grey colour. The impressive diameter of 100 cm creates space for various drinks or chilled dishes (page 49).



"Konkret!"



buffet display "Konkret!"

fibreglass/resin, dark grey (concrete look), not dishwasher-safe, splash-proof, hollow inside, bottom side open

item	l x w x h in cm
8200.12D	24x24x12
8200.24D	24x24x24
8200.36D	24x24x36



buffet display "Konkret!"

fibreglass/resin, dark grey (concrete look), not dishwasher-safe, splash-proof, hollow inside, bottom side open

item	l x w x h in cm	PU
8210.04D	12x12x4	2 pcs
8210.08D	12x12x8	2 pcs
8210.12D	12x12x12	2 pcs
8210.16D	12x12x16	2 pcs
8210.20D	12x12x20	2 pcs



The glass bowls are available on page 179.



buffet display "Konkret!"

fibreglass/resin, light grey (concrete look), not dishwasher-safe, splash-proof, hollow inside, bottom side open

item	l x w x h in cm
8200.12L	24x24x12
8200.24L	24x24x24
8200.36L	24x24x36



buffet display "Konkret!"

fibreglass/resin, light grey (concrete look), not dishwasher-safe, splash-proof, hollow inside, bottom side open

item	l x w x h in cm	PU
8210.04L	12x12x4	2 pcs
8210.08L	12x12x8	2 pcs
8210.12L	12x12x12	2 pcs
8210.16L	12x12x16	2 pcs
8210.20L	12x12x20	2 pcs



The XXL bowl in dark-grey concrete look inspires by its enormous size and the little weight. In empty state it can easily be carried by one person. A filigree, but extremely solid stand made of galvanized and powder-coated steel forms the perfect basis. A round glass plate separates ice from melting water and at the same time creates space for the Zieher rechargeable LED-light (page 39), which allows the illumination of the ice in striking colours. No matter if placed on the buffet table or on the stand - this bowl will leave a permanent impression on your guests!



XXL bowl "Konkret!"

fibreglass/resin, dark grey (concrete look), round, double-walled, not dishwasher-safe, waterproof-coated inside

item	Ø in cm	height in cm
8212.D	100	28



The separating plate "Milky" is kept in position by a bearing edge integrated in the bowl.

The rechargeable LED-light item 8150 is available on page 39.



rack for XXL bowl "Konkret!"

galvanised steel, matt black (powder-coated), threepart for self assembly, adjustable feet for firm positioning on most surfaces, for XXL bowl "Konkret!" item 8212.D

item	l x w x h in cm
8213	70x70x57

buffet platter/separating plate "Milky"

hardened glass, frosted look, round, edge polished and deburred, 10 mm thick, separates ice and melt water

item	Ø in cm
5240.M	60



buffet stand "Basic"

stainless steel 18/10 brushed (pipe Ø 3.2 cm), with felt pad at the top (black)

item	Ø in cm	height in cm	PU
8080.04	7	4	2 pcs
8080.08	7	8	2 pcs
8080.16	7	16	2 pcs
8080.24	7	24	2 pcs



"Basic"



Food: Pâtisserie Walter (www.patisserie.de)

"Basic" is the simple and flexible solution to create different presentation levels. The high-quality columns made of matt brushed stainless steel (18/10) are a fitting base for buffet platters made of glass and other materials. The columns are fitted with felt pads on the top to protect the surface of glass platters and to level out any unevenness of the tables. The feet with 7 cm in diameter guarantee firm standing. The unobtrusive and unadorned design of the buffet stands puts the food and drinks in the limelight.



"Basic" is available in four heights and can be combined with several Zieher buffet systems (pages 28 and 29). The carbon buffet stands "V12" presented here can be found on pages 42 to 44.

Please note: We do not recommend the use of "Basic" in combination with buffet platters made of natural slate. Due to the slightly varying thickness of natural slate platters, this combination might shake.



The card holder made of stainless steel is available on page 100.

Buffet platters and more!

Zieher is offering a wide range of buffet platters made of laminated plastic, natural slate and several kinds of glass. Due to the wide choice of formats and types of materials, there are many combination possibilities with Zieher's buffet systems (pages 5 to 51). The offer is being completed by various buffet stairs, trays and bowls (pages 62 to 97).

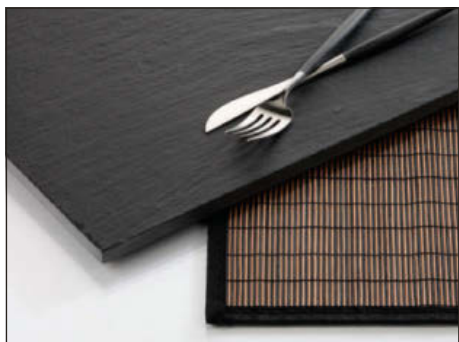

Natural slate, page 53

- Food-safe sealed/unsealed
- 10 - 15 mm thick
- With rubber feet



Laminated plastic, page 54

- Dark grey, black intermediate ply
- 8 mm thick
- Break-proof
- Dishwasher-safe
- Scratch-proof
- Antistatic



Laminated plastic, page 55 New!

- Old varnish white or rusted look, black intermediate ply
- 8 mm thick
- Break-proof
- Dishwasher-safe
- Scratch-proof
- Antistatic

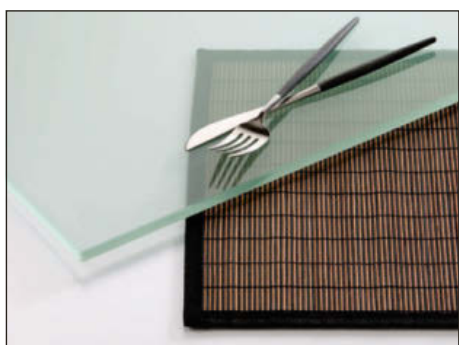

Satin glass, page 56

- Specially hardened safety glass
- 10 mm thick
- Edges polished and deburred
- Underside satined
- Dishwasher-safe

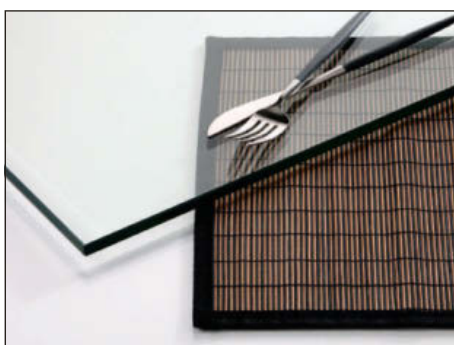

Transparent glass, page 57

- Specially hardened safety glass
- 10 mm thick
- Edges polished and deburred
- Dishwasher-safe



Black glass, page 58

- Specially hardened safety glass
- 4 mm thick, low weight
- Edges polished and rounded
- Underside scratch-resistant, black
- Shock-proof, heat-resistant, dishwasher-safe



White glass, page 59

- Special hardened safety glass
- 4 mm thick, low weight
- Edges rounded and polished
- Underside scratch-resistant, white
- Shock-proof, heat-resistant, dishwasher-safe

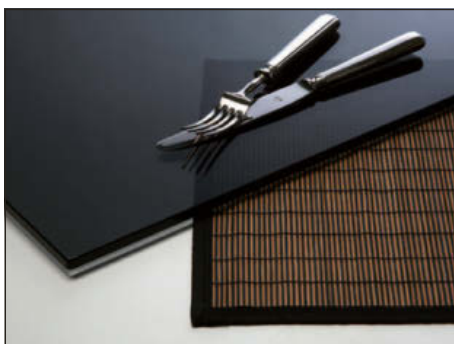

Dark grey glass, page 60

- Specially hardened safety glass
- 10 mm thick, transparent
- Edges polished and deburred
- Dishwasher-safe



Structured glass, page 61

- Special hardened safety glass
- 5 or 8 mm thick (depending on size)
- Edges rounded
- Underside structured
- Irregular colouring in cloudy optic
- Dishwasher-safe

Buffet platters made of slate!

- Natural slate
- Food-safe sealed/unsealed
- 10 to 15 mm thick
- With rubber feet

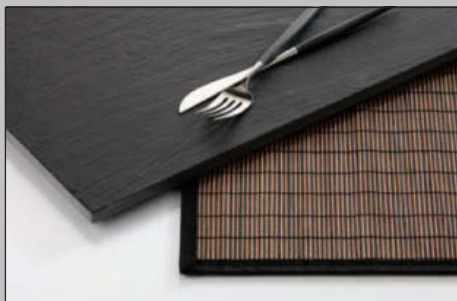

buffet platter, slate

natural slate, food-safe (sealed), with rubber feet, not dishwasher-safe, 10 to 15 mm thick

item	version	l x w in cm
8005.01	square	50x50
8005.02	rectangular	50x42
8005.03	rectangular	50x34
8005.04	square	42x42
8005.05	rectangular	42x34
8005.06	square	34x34
8005.07	rectangular	60x40
8005.08	rectangular	80x20
8005.09	rectangular	80x40



buffet platter 1/1 GN, slate

natural slate, rectangular, unsealed, with rubber feet, not dishwasher-safe, 10 to 15 mm thick

item	l x w in cm
8020	53x32.5



buffet platter, slate

natural slate, round, food-safe (sealed), with rubber feet, not dishwasher-safe, 10 to 15 mm thick

item	Ø in cm
8005.21	60



dinner plate

natural slate, food-safe (sealed), with rubber feet, not dishwasher-safe, approx. 5 mm thick

item	version	l x w in cm
2543.30	square	30x30
2544.30	rectangular	30x20

Slate is a unique and exceptional natural product. The surfaces of our slate plates have the typical cleavage. Every piece is therefore unique. Small deviations in structure, thickness (10 to 15 mm) and weight of the platters cannot be avoided because it is in the nature of the product. Also there could be single inclusions of other minerals and fossils. These exceptional features give slate its precious and vivid appearance. Please note: Specific groceries, especially those that contain fruit acid (citric acid) may damage the surface in case of longer contact. Therefore we recommend avoiding any direct contact with edibles.



The miniature saucers made of slate are available on page 242, the "Amuse" series on pages 216 to 220.



Buffet platters made of laminated plastic!

- Dark grey, black intermediate ply
- 8 mm thick
- Break-proof
- Dishwasher-safe
- Scratch-proof, antistatic

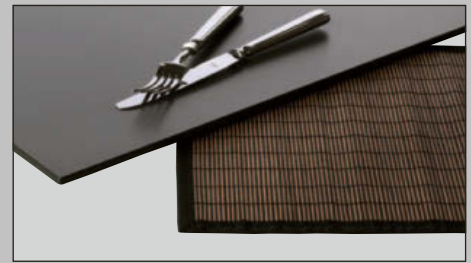

The "Amuse" series is available on pages 216 to 220.

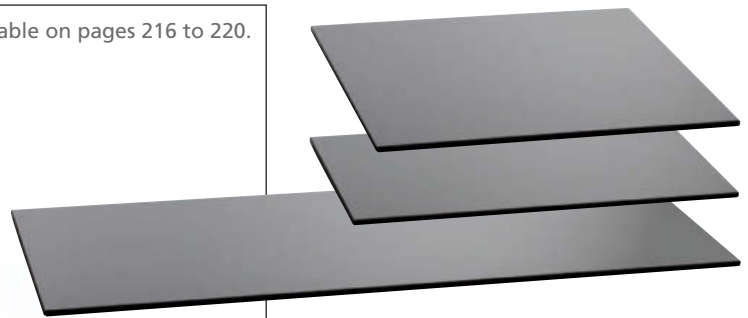

buffet platter, laminated plastic

laminated plastic, dark grey, black intermediate ply, deburred edges, rounded corners, break-proof, scratch-proof, dishwasher-safe, antistatic, 8 mm thick

item	version	l x w in cm
8006.01	square	50x50
8006.02	rectangular	50x42
8006.04	square	42x42
8006.06	square	34x34
8006.08	rectangular	80x21
8006.11	1/1 GN	53x32,5
8006.13	rectangular	95.4x39

"DressCoat" is available on pages 150 and 151.



The buffet stands "Basic" are available on page 50,
"Konkret!" on pages 46 to 49.



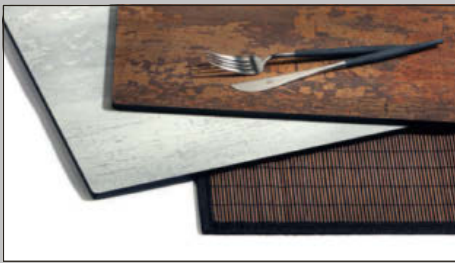

Buffet platters made of laminated plastic!

- Old varnish white / rusted look, black intermediate ply
- 8 mm thick
- Break-proof
- Dishwasher-safe
- Scratch-proof, antistatic

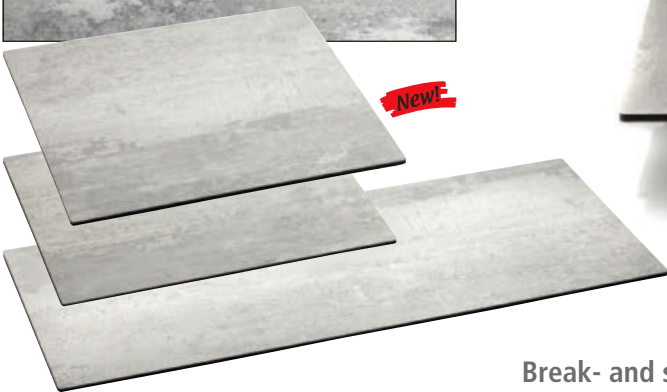

buffet platter "Shabby Chic"

laminated plastic, old varnish white, black intermediate ply, deburred edges, rounded corners, break-proof, scratch-proof, dishwasher-safe, antistatic, 8 mm thick

item	version	l x w in cm
8002.01	square	50x50
8002.02	rectangular	50x42
8002.04	square	42x42
8002.06	square	34x34
8002.08	rectangular	80x21
8002.11	1/1 GN	53x32.5
8002.13	rectangular	95.4x39



Break- and scratch-resistant, antistatic and dishwasher-safe - these features of laminated plastic platters and the resulting advantages are convincing! The well-known dark grey buffet platters are complemented by two new versions. The old varnish white "Shabby Chic" decor is reminiscent of exfoliating paint from antique doors and furniture. It emphasizes the radiance of imperfection and perfectly fits the furnishings of the attractive chalet style. Unplastered brick-lined walls, load-bearing structural elements made of steel beams, exposed concrete and the morbid charms of abandoned factory buildings create the ambience for the rust-coloured decoration "Industry". This is evocative of weathered steel surfaces, which are marked by decades of corrosion. All laminated buffet platters by Zieher have a dark middle layer and can be used on both sides due to having the decoration on both sides.

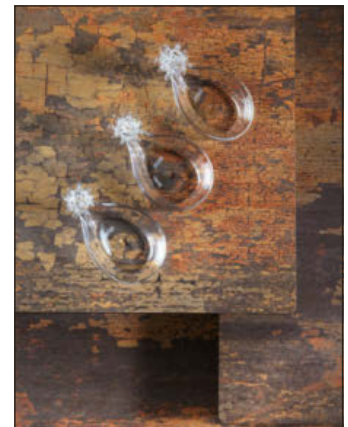

buffet platter "Industry"

laminated plastic, rusted look, black intermediate ply, deburred edges, rounded corners, break-proof, scratch-proof, dishwasher-safe, antistatic, 8 mm thick

item	version	l x w in cm
8003.01	square	50x50
8003.02	rectangular	50x42
8003.04	square	42x42
8003.06	square	34x34
8003.08	rectangular	80x21
8003.11	1/1 GN	53x32.5
8003.13	rectangular	95.4x39



Please note: With these decors each plate is unique, none of them look alike.

Buffet platters made of satined glass!

- Special hardened safety glass
- 10 mm thick
- Edges polished and deburred
- Underside satined
- Dishwasher-safe

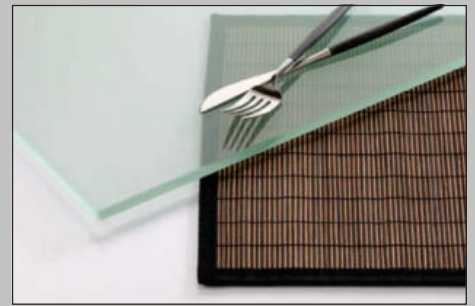

buffet platter, satined glass

hardened glass, frosted look, edges polished and deburred, 10 mm thick

item	version	l x w in cm
8004.01M	square	50x50
8004.04M	square	42x42
5243.M	rectangular	80x21



buffet platter, satined glass

hardened glass, frosted look, round, edge polished and deburred

item	Ø in cm	thickness in mm
5239.M	53	8
5240.M	60	10



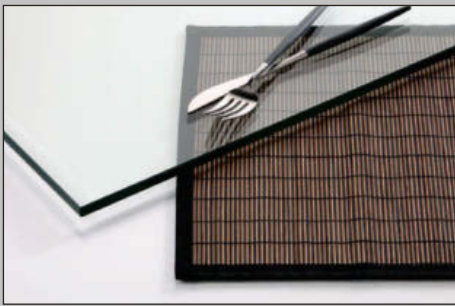

Buffet platters made of transparent glass!

- Special hardened safety glass
- 10 mm thick
- Edges polished and deburred
- Dishwasher-safe



buffet platter, transparent glass

hardened glass, transparent, edges polished and deburred, 10 mm thick

item	version	l x w in cm
8004.01	square	50x50
8004.02	rectangular	50x42
8004.03	rectangular	50x34
8004.04	square	42x42
8004.05	rectangular	42x34
8004.06	square	34x34
8004.07	2/1 GN	65x53
5243	rectangular	80x21
5000	rectangular	95.4x39

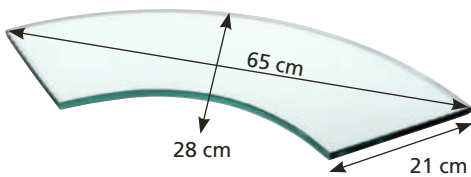

buffet platter "Curve 90°"

hardened glass, transparent, curved shape, edges polished and deburred, 10 mm thick

item	l x w in cm	PU
5241	65x28	2 pcs



buffet platter "Curve 45°"

hardened glass, transparent, curved shape, edges polished and deburred, 10 mm thick

item	l x w in cm
5242	62x37.5



dinner plate/glass insert

for serving tray "Solid" item 4710, hardened glass, edge polished and deburred, 6 mm thick

item	Ø in cm
4999	33

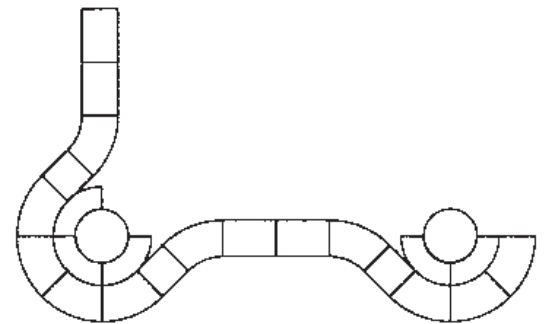
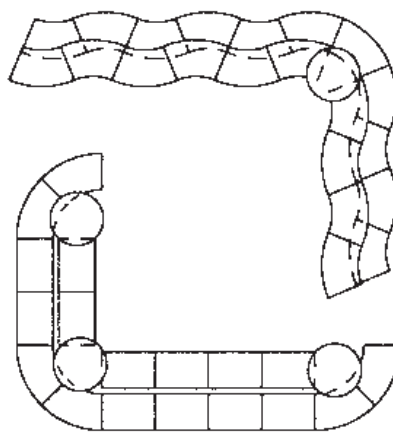
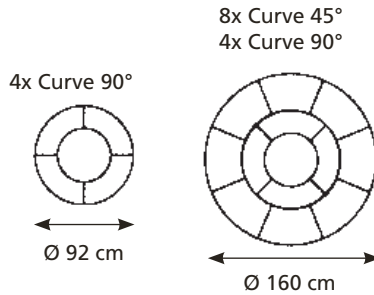

The curved platters combined with compatible buffet platters and buffet stands allow innumerable variations! These platters are available made of transparent glass (page 57), black glass (page 58), white glass (page 59) and transparent dark grey glass (page 60).



The "Lightning Buffet" is available on pages 36 to 39.

Buffet platters made of black glass!

- Special hardened safety glass
- 4 mm thick, low weight
- Edges rounded and polished
- Underside scratch-resistant, black
- Shock-proof, heat-resistant, dishwasher-safe
- Rubber feet can be stuck on if required



buffet platter, black glass

special hardened safety glass, black, rounded edges, polished rim, dishwasher-safe, rubber feet included (adhesive), underside scratch-proof, 4 mm thick

item	version	l x w in cm
1668.01	square	50x50
1668.03	rectangular	50x34
1668.04	square	42x42
1668.05	rectangular	42x34
1668.06	square	34x34
1668.08	rectangular	80x20
1668.09	rectangular	80x40
1668.10	rectangular	30x18
1668.11	1/1 GN	53x32.5
1668.12	rectangular	66x10

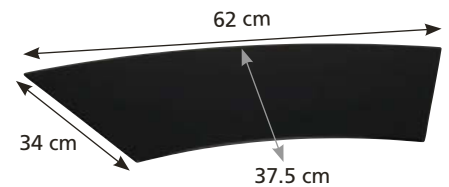

buffet platter "Curve 45°"

special hardened safety glass, black, rounded edges, polished rim, dishwasher-safe, rubber feet included (adhesive), underside scratch-proof, 4 mm thick

item	l x w in cm	PU
1668.14	62x37.5	2 pcs

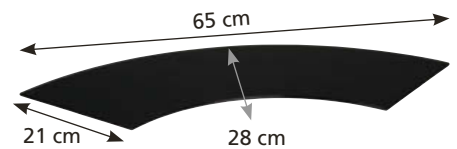

buffet platter "Curve 90°"

special hardened safety glass, black, rounded edges, polished rim, dishwasher-safe, rubber feet included (adhesive), underside scratch-proof, 4 mm thick

item	l x w in cm	PU
1668.15	65x28	2 pcs



dinner plate, black glass

special hardened safety glass, black, edge polished, dishwasher-safe, rubber feet included (adhesive), underside scratch-proof, 4 mm thick

item	Ø in cm
1669.33	33



buffet platter, black glass

special hardened safety glass, black, edge polished, dishwasher-safe, rubber feet included (adhesive), underside scratch-proof, 4 mm thick

item	Ø in cm
1669.53	53



Buffet platters made of white glass!

- Special hardened safety glass
- 4 mm thick, low weight
- Edges rounded and polished
- Underside scratch-resistant, white
- Shock-proof, heat-resistant, dishwasher-safe
- Rubber feet can be stuck on if required



buffet platter, white glass

special hardened safety glass, white, rounded edges, polished rim, dishwasher-safe, rubber feet included (adhesive), underside scratch-proof, 4 mm thick

item	version	l x w in cm
1670.01	square	50x50
1670.03	rectangular	50x34
1670.04	square	42x42
1670.06	square	34x34
1670.08	rectangular	80x20
1670.09	rectangular	80x40
1670.10	rectangular	30x18
1670.12	rectangular	66x10

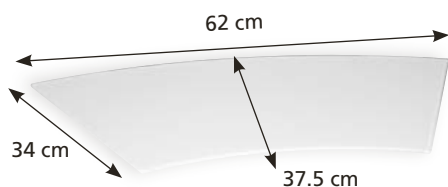

buffet platter "Curve 45°"

special hardened safety glass, white, rounded edges, polished rim, dishwasher-safe, rubber feet included (adhesive), underside scratch-proof, 4 mm thick

item	l x w in cm	PU
1670.14	62x37.5	2 pcs

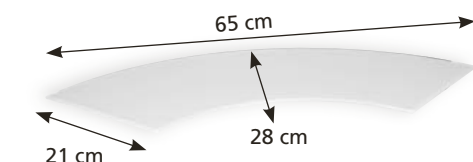

buffet platter "Curve 90°"

special hardened safety glass, white, rounded edges, polished rim, dishwasher-safe, rubber feet included (adhesive), underside scratch-proof, 4 mm thick

item	l x w in cm	PU
1670.15	65x28	2 pcs



dinner plate, white glass

special hardened safety glass, white, edge polished, dishwasher-safe, rubber feet included (adhesive), underside scratch-proof, 4 mm thick

item	Ø in cm
1671.33	33



buffet platter, white glass

special hardened safety glass, white, edge polished, dishwasher-safe, rubber feet included (adhesive), underside scratch-proof, 4 mm thick

item	Ø in cm
1671.53	53



Buffet platters made of dark grey glass!

- Special hardened safety glass
- 10 mm thick
- Edges polished and deburred
- Dark grey, transparent
- Dishwasher-safe

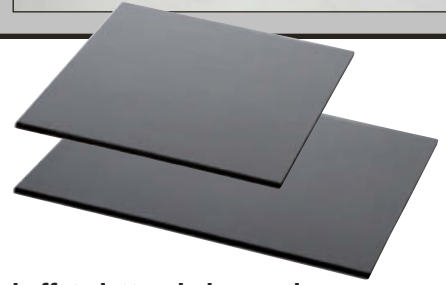

buffet platter, dark grey glass

hardened glass, dark grey, edges polished and deburred, 10 mm thick

item	version	l x w in cm
8004.01B	square	50x50
8004.02B	rectangular	50x42
8004.03B	rectangular	50x34
8004.04B	square	42x42
8004.05B	rectangular	42x34
8004.06B	square	34x34
8004.07B	2/1 GN	64x53
5243.B	rectangular	80x21
5000.B	rectangular	95.4x39

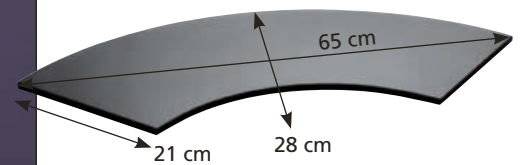

buffet platter "Curve 90°"

hardened glass, dark grey, curved shape, edges polished and deburred, 10 mm thick

item	l x w in cm	PU
5241.B	65x28	2 pcs

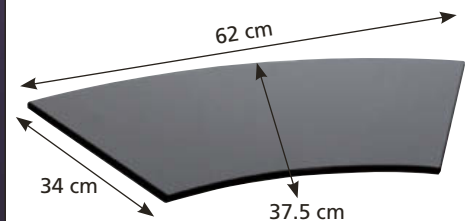

buffet platter "Curve 45°"

hardened glass, dark grey, curved shape, edges polished and deburred, 10 mm thick

item	l x w in cm
5242.B	62x37.5





Buffet platters made of structured glass!

- Special hardened safety glass
- 5 or 8 mm thick (depending on size)
- Edges rounded
- Underside structured
- Irregular colouring in cloudy optic
- Dishwasher-safe



The creamer is available on page 220.

Each piece is unique!

The irregular colouring of the Zieher buffet platters is created by colour pigments which are manually applied and fused into the glass. The colour is fixed inside

buffet platter, glass

hardened glass, grey transparent, irregularly coloured in a cloudy look, underside structured, dishwasher-safe, scratch-proof

item	version	l x w in cm	thickness in mm
8008.01	square	50x50	8
8008.02	rectangular	50x42	8
8008.03	rectangular	50x34	8
8008.04	square	42x42	5
8008.05	rectangular	42x34	5
8008.06	square	34x34	5
8008.07	2/1 GN	65x53	8
8008.08	rectangular	80x21	8
8008.13	rectangular	95.4x39	8

the glass and therefore dishwasher-safe and abrasion resistant. Structured undersides and rounded edges emphasize the effect of the platters and the individual and interesting shades of grey and intensity of colour create unique patterns in each platter!



Glass steps and more!



glass steps

deep black

5026.03: 32 cm long, 34 cm wide (horizontal position)

5026.04: 55 cm long, 42 cm wide (horizontal position)

item	l x w x h in cm (glass step)	thickness in mm
5026.03	29x34x12	6
5026.04	50x42x24	8



glass tray

deep black, rectangular, for buffet or flying buffet or functions as a tray

item	l x w x h in cm
5141.26	26x14x2
5141.34	34x18x2
5141.50	51x35x2



glass tray

deep black, square, for buffet or flying buffet, functions as a tray or as a dinner plate

item	l x w x h in cm
5142.34	35x35x2



Delivery of all big glass steps in a solid wooden box!



The buffet system "Skyline" is available on pages 6 to 12.



glass steps

5026.01: 32 cm long, 34 cm wide (horizontal position)
 5026.02: 55 cm long, 42 cm wide (horizontal position)

item	l x w x h in cm (glass step)	thickness in mm
5026.01	29x34x12	6
5026.02	50x42x24	8



glass steps

wavy, 7 steps, delivered in a wooden box,
 horizontal length: 67 cm
 vertical length: 65 cm (in setup with glass stand
 item 5070.01)

item	version	width in cm
5076.01	transparent	40
5076.02	black-grey	40



glass stand

transparent, curved, for glass steps items 5076...
 and 5026.01/03

item	w x h in cm	PU
5070.01	14x12	2 pcs

Please note: The glass steps items 5026... are adjusted to the Zieher system and due to their height of 12 resp. 24 cm can be combined easily with many Zieher buffet raisers (pages 28 and 29)! Miniatures made of black glass are available on page 237.



"Reef", pages 65 to 67



"Fakir", pages 68 and 69



"Matrix", pages 68 and 69



"Pueblo", page 70



"Capiz", page 71



"Shine", page 72



"Duplex", page 73



Glass bowls, pages 74 to 77



Glass, dark grey, page 77



"Artisan", pages 78 and 79



"Art de Buffet", pages 80 to 95



"Solid", page 114



Buffet bowls



"Reef"

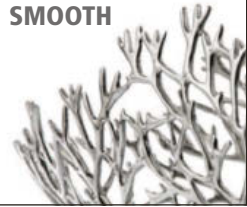

SMOOTH



The glass plate item 5700 is available on page 77, the cutlery "Goa" on page 300.

An assortment of bread and fruit in the hotel room or on the buffet table is put perfectly into the limelight by the transparency of the "Reef" items; carefully draped towels are also exquisitely presented in the bathroom or in the wellness area.



bowl/basket "Reef"

pewter, smooth outside, round, with supporting feet, food-safe, not dishwasher-safe, for small glass bowl item 5166 (please order separately)

item	Ø in cm	height in cm
2310	13	8



small bowl

glass, dark grey, organically shaped, 6 mm thick, for bowl/basket "Reef" item 2310 (please order separately)

item	Ø / height in cm	content in l	PU
5166	13 / 6.5	approx. 0.3	2 pcs

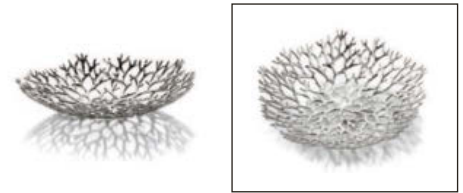

bowl/basket "Reef"

pewter, smooth outside, flat, round, food-safe, not dishwasher-safe

item	Ø in cm	height in cm
2311	22	5



bowl/basket "Reef"

pewter, smooth outside, high, round, food-safe, not dishwasher-safe

item	Ø in cm	height in cm
2312.01	36	45
2312.02	23	36



bowl/basket "Reef"

pewter, smooth outside, oval, food-safe, not dishwasher-safe

item	l x w x h in cm
2313.01	46x19x20
2313.02	32x13x13



"Reef"

STRUCTURED

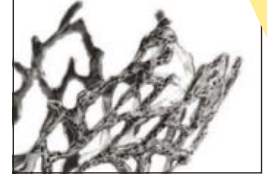

bowl/basket "Reef"

pewter, structured and patinated outside, oval, food-safe, not dishwasher-safe

item	l x w x h in cm
2332	20x10x12



bowl/basket "Reef"

pewter, structured and patinated outside, spherical, with supporting feet, food-safe, not dishwasher-safe

item	Ø in cm	height in cm
2333	23	23



bowl/basket "Reef"

pewter, structured and patinated outside, round, food-safe, not dishwasher-safe

item	Ø in cm	height in cm
2334	33	14



The bowls and baskets of the "Reef" series are veritable eye-catchers due to their organic structure and exceptional shapes. Many individual parts are assembled by hand to create truly extraordinary pieces of art that are reminiscent of the submarine world's coral reefs.

In the lobby or at the reception desk, which are both a hotel's hallmark, these impressive bowls guarantee lasting impressions with guests and visitors, especially when decorated with blossoms or flower bouquets.

The outside texture of the bowls differs within the series: whether smoothly rounded (page 66) or roughly structured with dark, patinated deepenings (page 67), each variant has its own charm!

bowl/basket "Reef"

pewter, structured and patinated outside, high, with supporting feet, food-safe, not dishwasher-safe

item	w x d x h in cm
2335	54x18x66

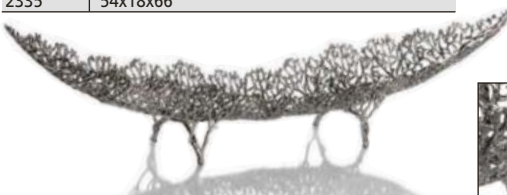

bowl/basket "Reef"

pewter, structured and patinated outside, long, with supporting feet, food-safe, not dishwasher-safe

item	l x w x h in cm
2336	75x10x14



bowl/basket "Reef"

in black gift box

item	l x w x h in cm
2336.PB	75x10x14

The displays of the "Classy" series are available on pages 30 and 31.



"Matrix"

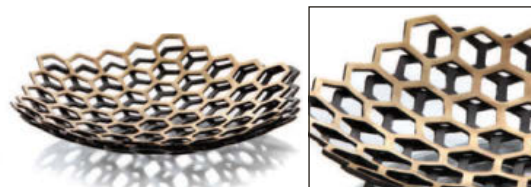

bowl "Matrix"

brass, top golden (transparent coating, food-safe), bottom dark patinated, hexagonal, flat, not dishwasher-safe

item	Ø in cm	height in cm
2382.38	38	7



bowl "Roots"

brass, golden (transparent coating, food-safe), round, not dishwasher-safe

item	Ø in cm	height in cm
2381.38	38	8

bowl "Roots"

in black gift box

item	Ø in cm	height in cm
2381.38PB	38	8

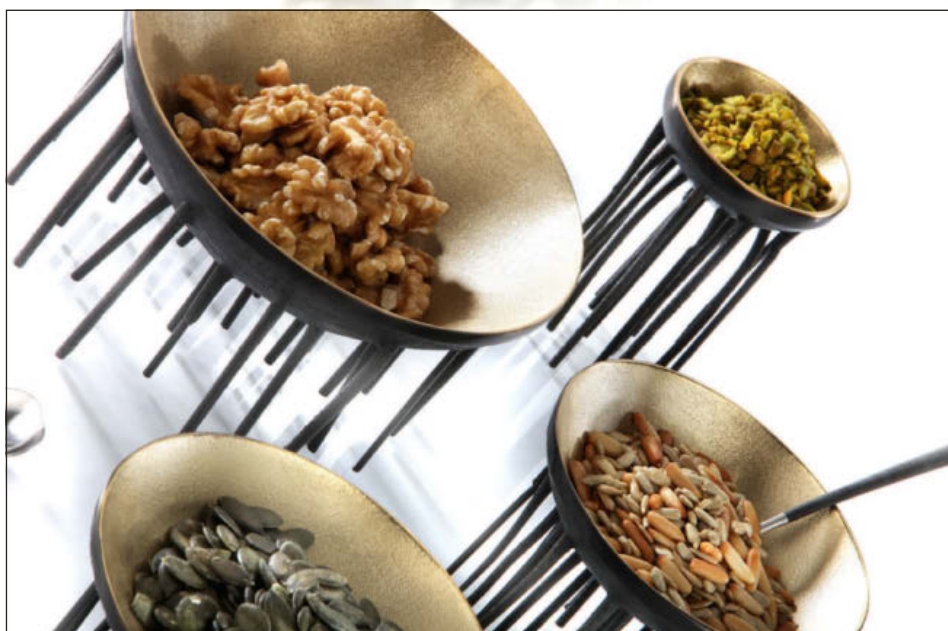

bowl/display "Fakir"

brass, inside golden (transparent coating, food-safe), outside dark patinated, not dishwasher-safe

item	Ø in cm	height in cm
2380.07	7.5	11
2380.12	12.5	10
2380.15	15	8.5
2380.18	18	9.5

The silicone feet may be detached if needed.



saucer "Solid"

hardened glass, transparent, with 4 transparent silicone feet, edge polished and deburred, 4 mm thick

item	Ø in cm	PU
5244.09	9	6 pcs
5244.11	11	6 pcs
5244	13	6 pcs
5244.17	16.7	1 pc.
5244.21	20.7	1 pc.
5244.24	24.2	1 pc.
5244.28	28.2	1 pc.

"Fakir"



“Roots, Matrix & Fakir” - Brass all of a piece!



Massive brass produced in traditional sand casting creates unique sculptural items, which enthuse especially by their contrast between matt golden surfaces and dark patination. Opposing in form and shape but still belonging together these bowls “Roots” and “Matrix” as well as the exceptional displays of the “Fakir” series add up to a harmonic overall composition.

The bowl “Roots”, a tight web of rootlike structures, and “Matrix”, strictly geometrically constructed of hexagons, could hardly be more opposing. Especially this aspect makes the combination of the two so interesting. Besides the presentation of bread and fruit on the buffet these bowls fascinate as sculptures or decorative elements as well. An interesting add-on to the “Fakir” bowls are round glass platters of the Zieher product range. These can be laid on easily and generate thus the option to use the impressive objects on both sides.

All items are golden-coloured and partially dark patinated, further discolouration or oxidation is prevented reliably by the food-safe sealing of the golden parts.



"Pueblo"



bowl "Pueblo"

stoneware, outside white (matt finish), inside taupe (glossy), round, organically shaped

item	Ø in cm	height in cm	content in l
4601.22	22.5	7	approx. 1.8
4601.27	27.5	8.5	approx. 3.2
4601.33	33.5	10.5	approx. 6.5



bowl "Pueblo"

stoneware, outside white (matt finish), inside taupe (glossy), oblong, organically shaped

item	l x w x h in cm	PU
4600.28	28.5x12.5x7	2 pcs
4600.35	35x15.5x8.5	1 pc.
4600.40	40x18x9.5	1 pc.
4600.45	45x20x11.5	1 pc.

The glasses of the series „VISION“ are available from pages 203.



The stoneware bowls "Pueblo", due to their appearance, are evocative of unique handmade pieces. The filigree body, organic shapes and the charming contrast between matt and shiny glaze award the certain something to that series.

The matt outside of the bowls generates a pleasantly soft haptic effect, shiny glazed insides are done in a stylish taupe colour.

The complete series "Pueblo" is available on page 152.



Ivory-coloured clamshells with a nacreous gloss grant these products their special appeal. In combination with crushed ice and the Zieher rechargeable LED-lights the double-walled bowls produced in mosaic-look create fascinating effects, thus becoming the eye-catcher at the buffet. The double-walled construction provides insulating characteristics. This prevents the formation of condensate on the outside of the bowls to the greatest possible extent. More items of the series are available on pages 174 and 175.



bowl "Capiz"

shell, ivory-coloured, resin-coated, round, double-walled, not dishwasher-safe, rim approx. 2 cm wide

item	Ø in cm	height in cm
7109.46	46	23

bowl "Capiz"

in black gift box

item	Ø in cm	height in cm
7109.46PB	46	23



Separates ice and melt water



dinner plate, white glass

special hardened safety glass, white, edge polished, dishwasher-safe, rubber feet included (adhesive), underside scratch-proof, 4 mm thick

item	Ø in cm
1671.33	33



bowl "Capiz"

shell, ivory-coloured, resin-coated, round, double-walled, with slightly cone-shaped bottom, not dishwasher-safe, rim approx. 3 cm wide

item	Ø in cm	height in cm
7112.36	36	17.5



bowl "Capiz"

shell, ivory-coloured, resin-coated, oval, not dishwasher-safe

item	l x w x h in cm
7106.46	46.5x24x13.5

The rechargeable LED-light item 8150 is available on page 39.



Please note the care instructions: suitable for cold and dry food, not dishwasher-safe.

"Shine"



The stainless steel bowls of the "Shine" series are double-walled and therefore have an isolating effect. This helps to prevent water condensation - even at elevated temperatures. Cold food stays cold and warm food stays warm longer.



The slim top edge appears elegant and filigree. The accentuated contrast between the highly polished outside and the unobtrusive finish on the inside (fine brushed stainless steel, ivory and taupe coloured) makes that series an eye-catcher. "Shine" is the perfect combination of elegance and subtlety. It is easily changeable to achieve a variation of presentations and it is effective in its double-walled construction.



DESIGN
by
ZIEHER



satined



bowl "Shine"

stainless steel 18/10, outside polished, inside satined, round/oblique, double-walled, dishwasher-safe

item	Ø in cm	height in cm	content in l
2260.16	15.7	6.7 / 8.8	0.5
2260.20	19.7	8.5 / 11	0.9
2260.24	23.7	10 / 13	1.6



ivory



bowl "Shine"

stainless steel 18/10, outside polished, food-safe coated inside (colour: ivory, not dishwasher-safe), round/oblique, double-walled

item	Ø in cm	height in cm	content in l
2261.16	15.7	6.7 / 8.8	0.5
2261.20	19.7	8.5 / 11	0.9
2261.24	23.7	10 / 13	1.6

bowl "Shine"

in black gift box

item	Ø in cm	height in cm	content in l
2261.16PB	15.7	6.7 / 8.8	0.5
2261.20PB	19.7	8.5 / 11	0.9
2261.24PB	23.7	10 / 13	1.6



taupe



bowl "Shine"

stainless steel 18/10, outside polished, food-safe coated inside (colour: taupe, not dishwasher-safe), round/oblique, double-walled

item	Ø in cm	height in cm	content in l
2262.16	15.7	6.7 / 8.8	0.5
2262.20	19.7	8.5 / 11	0.9
2262.24	23.7	10 / 13	1.6

Please note:

When cleaning the coated bowls (ivory and taupe coloured) in the dishwasher, the coating at the rim might abrade in the course of time. Therefore it is recommended to clean these items by hand.



Useable on both sides!

The grey solid coloured glass of these handblown unique pieces serves as an unobtrusive background and suitable framework for perfectly arranged dishes. The bowls can be used on both sides. A soft recess is formed when the closed side is up for ambitious dishes. By using it upside down there will be more capacity which is ideal e. g. to fill in ice.



bowl "Duplex"

grey glass, round, bottom side open

item	Ø in cm	height in cm
4813.28	28	6.5
4813.35	35	7.5
4813.46	46	10

Please note:

The bowls are mouth blown. Therefore it is impossible to avoid the variation in glass thickness and weight.



Glass bowls of highest quality -

made of 3 layers fused in one!



The fusion of two layers of coloured and one layer of crystal clear glass results in an inspiring depth effect and brilliance!



bowl

glass, with foot, heavy quality, outside black, inside grey-white

item	Ø in cm	height in cm	content in l
5365	25	19.5	5.5



bowl

glass, oblique, with foot, heavy quality, outside black, inside grey-white

item	Ø in cm	height in cm	content in l
5366	25	24	3.0



bowl

glass, heavy quality, outside black, inside white

item	Ø in cm	height in cm	content in l
5360	32	8.5	4.0



bowl

glass, heavy quality, outside white, inside black

item	Ø in cm	height in cm	content in l
5360.01	32	8.5	4.0



bowl

glass, heavy quality, outside black, inside white

item	Ø in cm	height in cm	content in l
5364	18	9.5	1.3
5363	23	12.5	3.0
5361	28	15	6.0



bowl

glass, with foot, heavy quality, outside black, inside white

item	Ø in cm	height in cm	content in l
5362	34.5	12.5	5.0

Manufactured in old tradition!



Each of these high grade bowls is unique and almost completely handcrafted. At this, coloured glass is completely covered with crystal clear glass. This process awards the bowls with top brilliance and an impressive look. The handblown glass blank is modelled manually, whereby unique pieces are created which excite by their organic shape.



bowl

glass, black with clear rim, wavy, handblown

item	Ø in cm	height in cm
4811.01	approx. 38-40	approx. 9.5
4811.02	approx. 50-52	approx. 14
4811.03	approx. 56-58	approx. 15



bowl

glass, white with clear rim, wavy, handblown

item	Ø in cm	height in cm
4810.01	approx. 38-40	approx. 9.5
4810.02	approx. 50-52	approx. 14
4810.03	approx. 56-58	approx. 15

Please note:

Due to the complex production process, small air inclusions in the glass are inevitable!



The buffet stands are available on page 94.



glass bowl

glass, transparent, square, structured, 6 mm thick

item	l x w x h in cm
5164	34.5x34.5x6



glass bowl

glass, transparent, rectangular, structured, 6 mm thick

item	l x w x h in cm
5165	56x22x5.7



buffet bowl "Milky"

glass, frosted look, concentric shape with steps

item	Ø in cm	height in cm
5013.46	46	5.5



buffet bowl

glass, wide rim

item	Ø in cm	height in cm
5024.45	45	11



buffet bowl "Milky"

glass, frosted look, square

item	l x w in cm
5014.38	38x38



buffet bowl

glass, wide rim

item	Ø in cm	height in cm
5025.46	46	6



glass tray

satined, rectangular

item	l x w x h in cm
5160.31	31x21x3.5
5160.62	62x21x3.5



glass platter

glass, transparent, square

item	l x w in cm
5063	30x30
5063.50	50x50



buffet bowl

glass, wide rim

item	Ø in cm	height in cm
5049.35	35	6



glass tray

dark grey, rectangular

item	l x w x h in cm
5161.31	31x21x3.5
5161.62	62x21x3.5

More dark grey glass platters are available on page 183.



The buffet diplays "Classy" are available on pages 30 and 31.

buffet bowl

glass, dark grey, oblong, textured

item	l x w x h in cm	thickness in mm
5703	96x29x10	8

The glass miniature is available on page 225, the cutlery "Goa" on page 300.



glass plate

dark grey, rectangular, with the structure of tree bark

item	l x w in cm	thickness in mm	PU
5702	40x22	8	2 pcs



glass plate

dark grey, oval, with the structure of tree bark

item	l x w in cm	thickness in mm	PU
5700	33x24	8	3 pcs



glass bowl

dark grey, oval, with the structure of tree bark

item	l x w x h in cm	thickness in mm	PU
5701	26.5x19.5x4.5	8	3 pcs

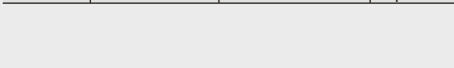

The cutlery/napkin box "Solid" is available on page 248.



"Artisan"



dinner plate "Artisan"

stainless steel 18/10, round, inside polished, outside matt finish, hammered rim with golden adornment (brass), utility space smooth finish

item	Ø in cm
2375.33	33



bread/pastry dish "Artisan"

stainless steel 18/10, oval, flat, inside polished, outside matt finish, hammered rim with golden adornment (brass), bottom smooth finish

item	l x w x h in cm
2372	22x15x3.5



bread/pastry dish "Artisan"

stainless steel 18/10, oval, high, inside polished, outside matt finish, hammered rim with golden adornment (brass), bottom smooth finish

item	l x w x h in cm
2373	22x13x7



bowl "Artisan"

stainless steel 18/10, round, inside polished, outside matt finish, hammered rim with golden adornment (brass)

item	Ø in cm	height in cm	content in l
2371.07	7.5	3.5	approx. 0.1
2371.11	11	5.5	approx. 0.3
2371.14	14.5	7	approx. 0.7



Please note: When cleaning in the dishwasher the brass rim may change colour in the course of time. Therefore it is recommended to clean these items by hand.



tray “Artisan”

stainless steel 18/10, oval, inside polished, outside matt finish, hammered rim with golden adornment (brass), utility space smooth finish

item	l x w in cm	height in cm
2374.24	24.5x15	approx. 1.5



The trays and bowls of the “Artisan” series are fascinating and diversified at the same time. The inside with its perfectly polished surface creates an interesting contrast to the matt outside.

The handcrafted rim impresses by its irregularity and is crowned by a circumferential brass edge. The combination of hammered and plain surfaces, of massive stainless steel and brass, awards this series with that certain something.

“Artisan” is a series of contrast!

tray “Artisan”

stainless steel 18/10, round, inside polished, outside matt finish, hammered rim with golden adornment (brass), utility space smooth finish

item	Ø in cm	height in cm
2370.23	23	approx. 2.5
2370.28	28	approx. 3
2370.33	33	approx. 3
2370.39	39	approx. 3.5



The plane surface of the trays facilitates the service and prevents unpleasant noise. When used at the buffet, arranged food can be presented in an appealing way and is accentuated by the reflection of the polished surfaces.

etagere “Artisan”

stainless steel 18/10, round, inside polished, outside matt finish, hammered rim with golden adornment (brass), with brass handle, demountable, with 3 rubber feet, not dishwasher-safe

item	Ø in cm	height in cm
2376	33/28/23	45



The buffet displays “Neo” are available on page 33.

Stainless steel - refined!

We gladly offer you buffet displays, bread baskets or cruet stands etc. with different surfaces. This option is feasible for almost all products made of stainless steel.

Highly polished as well as matt stainless steel can be refined in gold, copper or black colour in PVD refining. The products pictured on this page are parts of the Zieher range. Other items and refinements in black can be offered on demand.



stainless steel, polished

golden

copper

black

All items made of stainless steel can be powder-coated in all current RAL colours upon request. In contrast to the PVD refining this coating is not dishwasher-safe. We will be delighted to advise you!

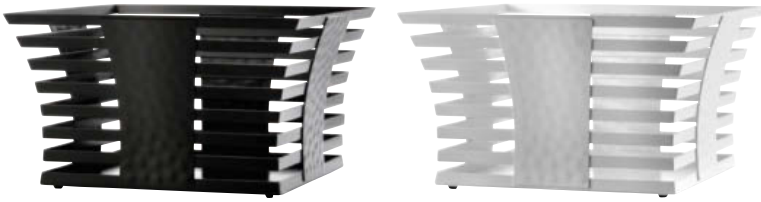

Price, minimum order quantity and delivery time upon request. Please ask us, we will gladly prepare an individual offer for you!



Advantages of the PVD coating

- Food-safe
- Dishwasher-safe
- Better strength and adherence compared to galvanic refinement
- Brilliant colouring, colourfast and resistant against UV radiation



bowl

massive stainless steel 18/10, oblong, hammered finish, six times polished, 41 cm long, 15.5 cm wide, 6.5 cm high

item	version
2116.41	stainless steel
2116.41G	stainless steel, golden
2116.41C	stainless steel, copper



bowl "Wings"

massive stainless steel 18/10, hammered finish, six times polished, 34 cm long, 22 cm wide, 48 cm high

item	version
2169	stainless steel
2169.G	stainless steel, golden
2169.C	stainless steel, copper



bowl

massive stainless steel 18/10, oblong, hammered finish, six times polished, 71.5 cm long, 22.5 cm wide, 11 cm high

item	version
2116.71	stainless steel
2116.71G	stainless steel, golden
2116.71C	stainless steel, copper



champagne bowl

massive stainless steel 18/10, hammered finish, six times polished, Ø 39 cm, 18 cm high, 18 l content

item	version
2163	stainless steel
2163.G	stainless steel, golden
2163.C	stainless steel, copper



chocolate/ice cube tongs

massive stainless steel 18/10, hammered finish, six times polished, 19 cm long

item	version
2138	stainless steel
2138.G	stainless steel, golden
2138.C	stainless steel, copper

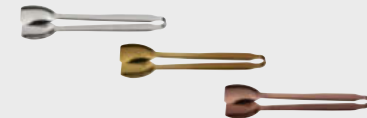

serving tongs

massive stainless steel 18/10, hammered finish, six times polished, 21.5 cm long

item	version
2140	stainless steel
2140.G	stainless steel, golden
2140.C	stainless steel, copper



bowl "Sixth Sense"

massive stainless steel 18/10, with stainless steel feet, hammered finish, six times polished, 15.5 cm long, 8 cm wide, 24.5 cm high

item	version
2171.03	stainless steel
2171.03G	stainless steel, golden
2171.03C	stainless steel, copper

“Art de Buffet”

The exceptional design of the “Art de Buffet” series acts as an eye-catcher at both modern and elegantly traditional buffets. It presents artistically arranged dishes in a favourable way. Every piece of this series is made of massive stainless steel 18/10, has a hand-made hammered finish and is six times hand-polished.



The XXL bowl item 2170 is available on page 89.

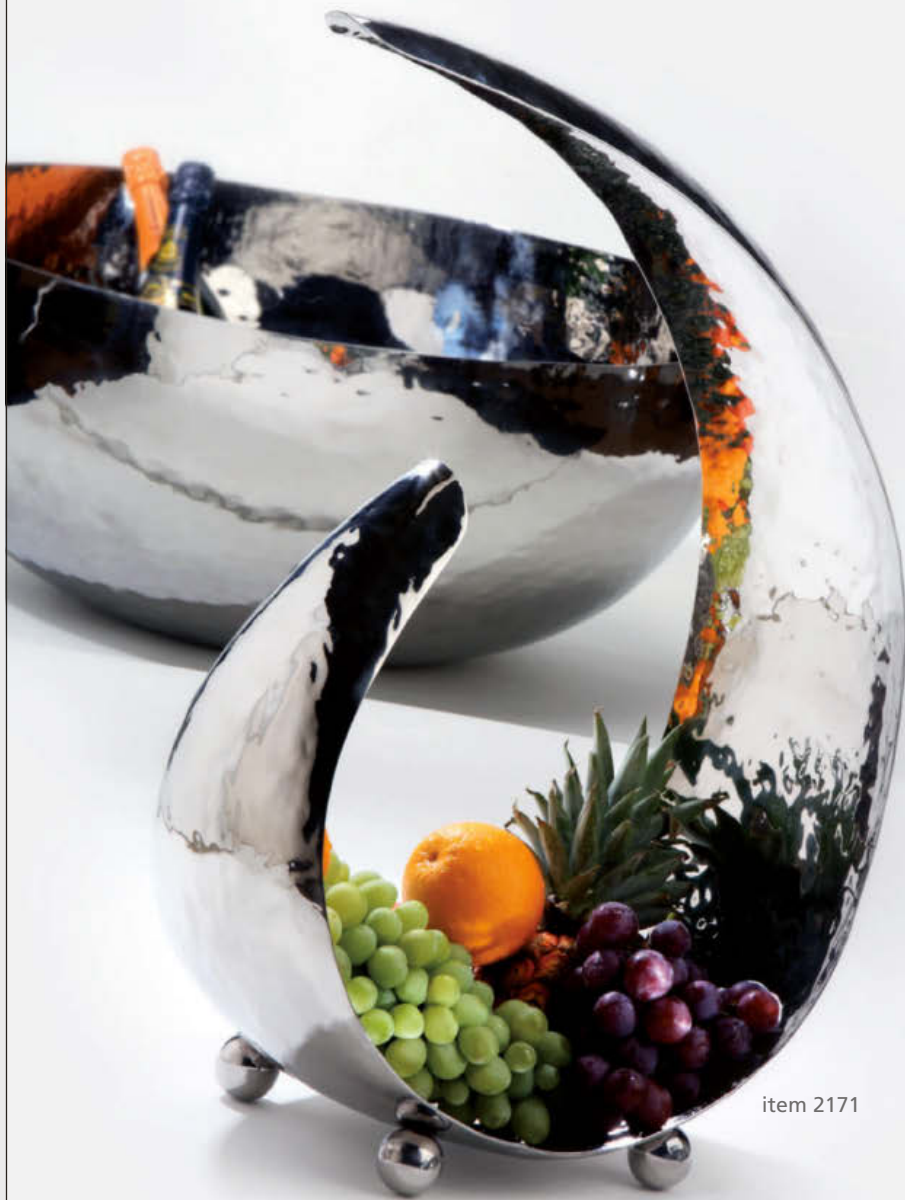

item 2171

item 2171



bowl "Sixth Sense"

massive stainless steel 18/10, with stainless steel feet, hammered finish, six times polished

item	l x w x h in cm
2171	48x25x74
2171.01	37x17.5x54
2171.02	20x12x34



bowl "Sixth Sense"

massive stainless steel 18/10, with stainless steel feet, hammered finish, six times polished, 15.5 cm long, 8 cm wide, 24.5 cm high

item	version
2171.03	stainless steel
2171.03G	stainless steel, golden
2171.03C	stainless steel, copper



bowl/tray

massive stainless steel 18/10, oblong curved, hammered finish, six times polished

item	l x w x h in cm
2112	30.5x7.5x6

The stainless steel bowls are available on page 86.





Please note:
The baseplate has to be mounted!

bowl "Loop"

massive stainless steel 18/10, oval, hammered finish, six times polished, with black marble foot

item	l x w x h in cm
2109	39x19x67

bowl "Loop"

in black gift box

item	l x w x h in cm
2109.PB	39x19x67

"Art de Buffet"



The bread/pastry bowls are available on page 90.



bowl "Wings"

massive stainless steel 18/10, hammered finish, six times polished, 34 cm long, 22 cm wide, 48 cm high

item	version
2169	stainless steel
2169.G	stainless steel, golden
2169.C	stainless steel, copper



bowl "Wings"

massive stainless steel 18/10, hammered finish, six times polished

item	l x w x h in cm
2169.01	21x12.5x30.5
2169.02	15.5x9x19



"Art de Buffet"

DESIGN
by
ZEHER



HAMMERED



etagere

massive stainless steel 18/10, triangular, hammered finish, six times polished, not demountable

item	Ø in cm	height in cm
2180	40	51



bowl

massive stainless steel 18/10, triangular, hammered finish, six times polished

item	Ø in cm	height in cm	content in l
2180.09	9	4	0.08
2180.13	13	6	0.28
2180.22	22	10.5	1.25
2180.30	30	12	3.0
2180.40	40	16	7.0

bowl

in black gift box

item	Ø in cm	height in cm	content in l
2180.22PB	22	10.5	1.25
2180.30PB	30	12	3.0

bowl

massive stainless steel 18/10, oval, hammered finish, six times polished

item	l x w x h in cm
2183	40x23x9/18.5



The servers "Mao" are available on page 298, the rings made of silicone on page 169.

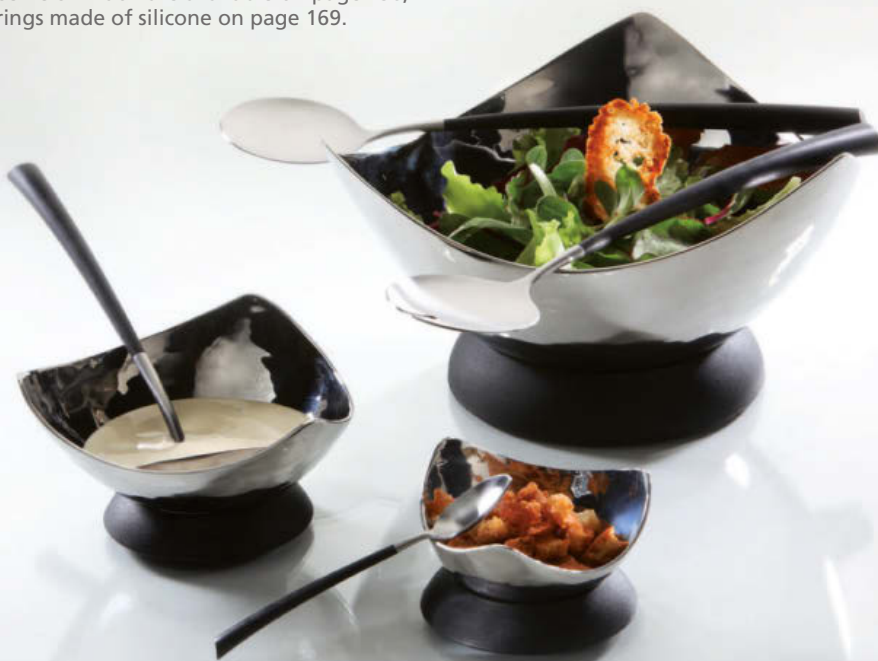

SMOOTH



etagere

massive stainless steel 18/10, triangular, smooth finish, six times polished, not demountable

item	Ø in cm	height in cm
2187	13	16.5



bowl

massive stainless steel 18/10, triangular, smooth finish, six times polished

item	Ø in cm	height in cm	content in l
2182.09	9	4	0.08
2182.13	13	6	0.28
2182.22	22	10.5	1.25
2182.30	30	12	3.0



bowl

massive stainless steel 18/10, oval, smooth finish, six times polished

item	l x w x h in cm	content in l
2159.16	16x10x3.5/7	approx. 0.2
2159.20	20x12x5/9	approx. 0.35

bowl

in black gift box

item	l x w x h in cm	content in l
2159.16PB	16x10x3.5/7	approx. 0.2
2159.20PB	20x12x5/9	approx. 0.35





etagere

massive stainless steel 18/10, round, with stainless steel feet (spherical shape), hammered finish, six times polished, not demountable

item	Ø in cm	height in cm
2197	50/40/30	33



Feet ensure safe standing!

The servers "Mao" are available on page 298, the bread bowls "Solid" on page 114.

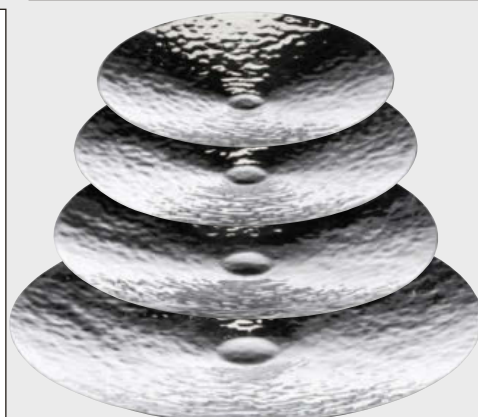

bowl

massive stainless steel 18/10, with 4 feet, hammered finish, six times polished

item	Ø in cm	height in cm
2199.30	30	3.5
2199.35	35	4
2199.40	40	4.5
2199.50	50	5



dressing jar

massive stainless steel 18/10, double-walled, polished inside, hammered finish outside, six times polished

item	Ø in cm	height in cm	content in l
2176	14	15.5	1.5



etagere

massive stainless steel 18/10, round, hammered finish, six times polished, not demountable

item	Ø in cm	height in cm
2198	27/22/18/14	50

etagere

in black gift box

item	Ø in cm	height in cm
2198.PB	27/22/18/14	50

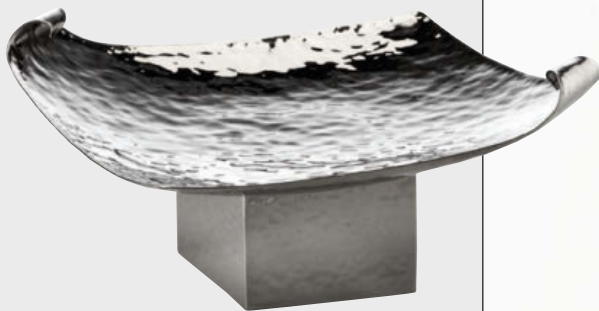

buffet tray

massive stainless steel 18/10, with foot, hammered finish, six times polished

item	l x w x h in cm
2128	55x42x17



buffet bowl

massive stainless steel 18/10, hammered finish, six times polished

item	Ø in cm	height in cm
2122	47	9



bowl

massive stainless steel 18/10, oval, hammered finish, six times polished

item	l x w x h in cm
2117	40.5x25x8.5

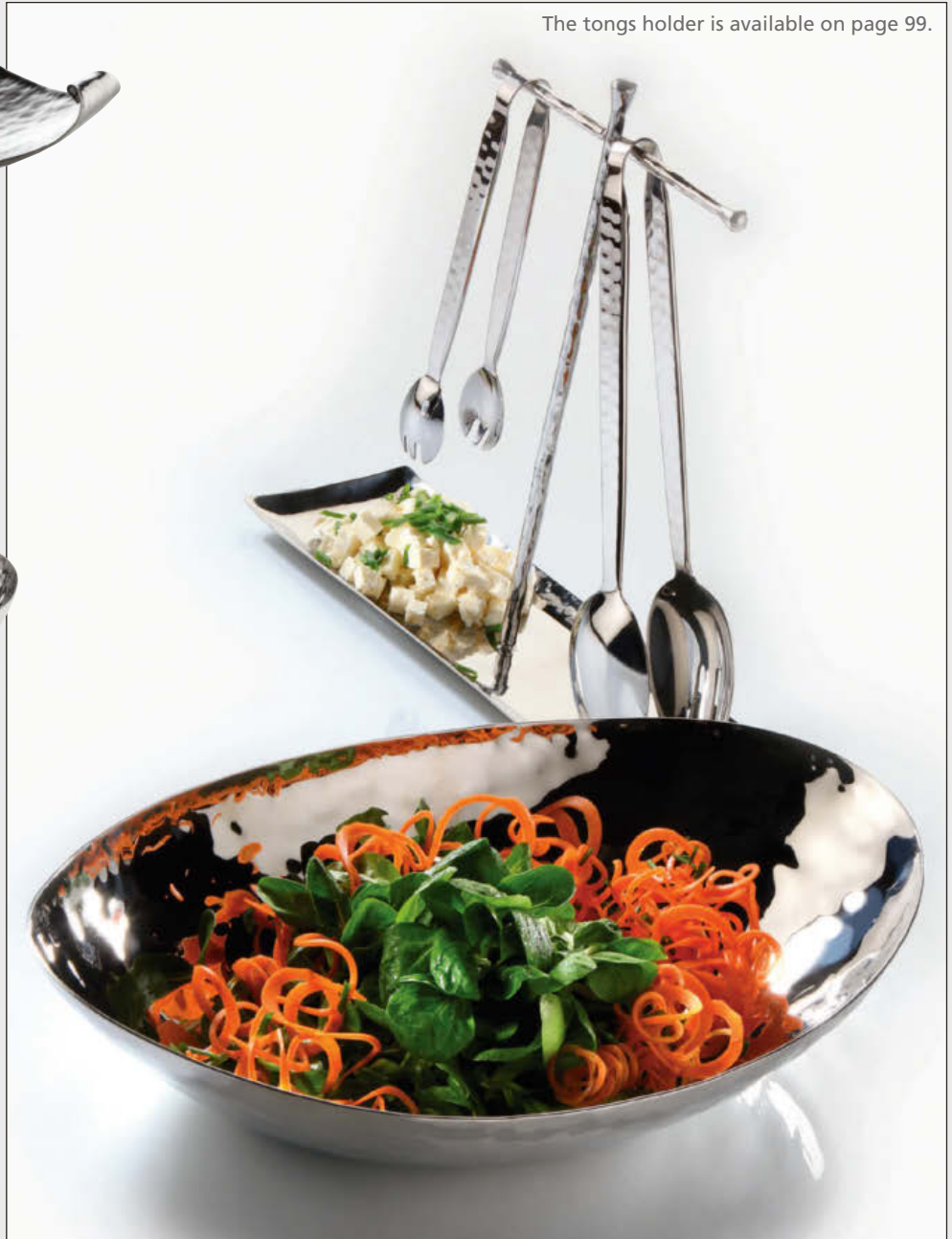

The tongs holder is available on page 99.

The five-stage etagere item 2119 is available on page 96.



items 2163
+
5024.45
(page 76)



bowl

massive stainless steel 18/10, oblong, hammered finish, six times polished, 41 cm long, 15.5 cm wide, 6.5 cm high

item	version
2116.41	stainless steel
2116.41G	stainless steel, golden
2116.41C	stainless steel, copper



champagne bowl

massive stainless steel 18/10, hammered finish, six times polished, Ø 39 cm, 18 cm high, 18 l content

item	version
2163	stainless steel
2163.G	stainless steel, golden
2163.C	stainless steel, copper



bowl

massive stainless steel 18/10, oblong, hammered finish, six times polished, 71.5 cm long, 22.5 cm wide, 11 cm high

item	version
2116.71	stainless steel
2116.71G	stainless steel, golden
2116.71C	stainless steel, copper

For the XXL bowl with 85 l total content we suggest to use 2 - 3 LED-lights item 8150 (page 39) for illumination.



XXL bowl with 85 l content



bowl/basin XXL

massive stainless steel 18/10, round, hammered finish, six times polished

item	Ø in cm	height in cm	content in l
2170	70	30	85

illuminated champagne bowl

set consists of:

champagne bowl made of massive stainless steel 18/10, polished

2 rechargeable LED-lights, with charging device and remote control

separating plate made of hardened glass (10 mm thick), satined

item	Ø / height in cm	content in l	PU
2200.PB	70 / 30	85	1 set (6 parts)



buffet platter/separating plate "Milky"

hardened glass (10 mm thick), frosted look, reduces useable capacity of XXL bowl to approx. 40 l content (15 cm usable depth)

item	Ø in cm
5240.M	60

Separates ice and melt water items 2170 + 8150 + 5240.M



"Art de Buffet"

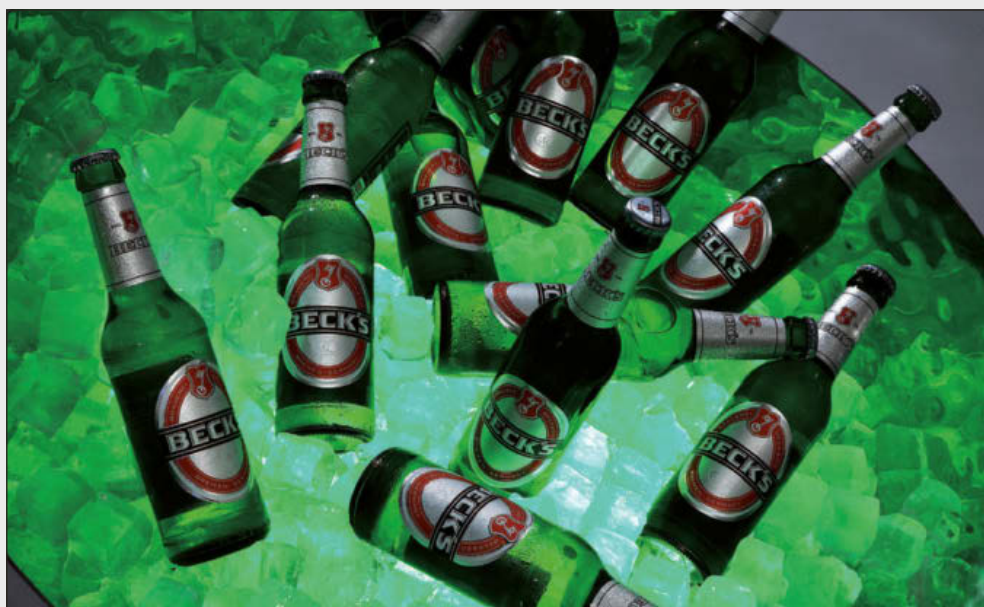

The bowl "Sixth Sense" is available in 4 sizes on page 82.



The XXL bowl "Konkret!" is available on page 49.



The bowl "Loop" is available on page 83.



bowl

massive stainless steel 18/10, round, hammered finish, six times polished

item	Ø in cm	height in cm	content in l
2181.17	17	6.5	1.1
2181.21	21	8.0	2.0
2181.24	24	9.5	3.25

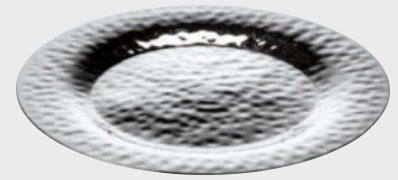

dinner plate

massive stainless steel 18/10, round, hammered finish, six times polished

item	Ø in cm
2161	33



bread/pastry dish

massive stainless steel 18/10, hammered finish, six times polished

item	l x w x h in cm
2133.12	12x7.5x4.5
2133.19	19x11.5x6.5

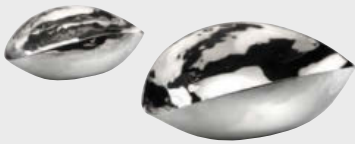

bowl

massive stainless steel 18/10, round, high, hammered finish, six times polished

item	Ø in cm	height in cm	content in l
2181.14	14	7.5	1.0



plate, deep

massive stainless steel 18/10, deep, with wide rim, hammered finish, six times polished

item	Ø in cm	height in cm	content in l
2118	26.5	6	0.5



bread/pastry dish

massive stainless steel 18/10, hammered finish, six times polished

item	l x w x h in cm
2121.22	24x15x8

bowl

massive stainless steel 18/10, oval, hammered finish, six times polished, 9 cm long, 6 cm wide, 0.10 l content

item	version
2149.07	without spiral clip
2155.01	with spiral clip

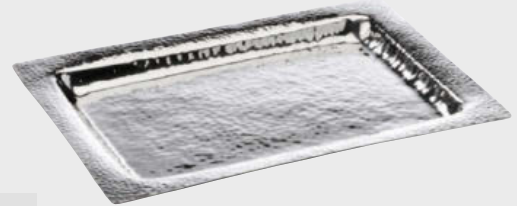

tray

massive stainless steel 18/10, rectangular, hammered finish, six times polished

item	l x w in cm
2186	38x28



small bowl

massive stainless steel 18/10, round, hammered finish, six times polished, Ø 7.5 cm, 0.11 l content

item	Ø in cm
2153	without spiral clip
2155	with spiral clip



bread basket

massive stainless steel 18/10, hammered finish, six times polished

item	l x w x h in cm
2131	24x16x4

small bowl

massive stainless steel 18/10, round, smooth finish, six times polished

item	Ø in cm	content in l
2153.01	7.5	0.11



tray

massive stainless steel 18/10, rectangular, hammered finish, six times polished

item	l x w in cm
2127	57x42



etagere

massive stainless steel 18/10, including three removable trays item 2110.01 (30 cm long, 8 cm wide, 3 cm high), hammered finish, six times polished

item	l x w x h in cm (etagere only)
2110	11.5x11.5x39 (height without handle)



tray with feet

massive stainless steel 18/10, rectangular, hammered finish, six times polished, for buffet etagere item 2110

item	l x w x h in cm
2110.01	30x8x3



The jam trays are available on page 272.



Elegantly served - stylishly presented!

Whether it is five o'clock tea, breakfast or finger food - etageres by Zieher offer a maximum use of minimum space.

toast rack

massive stainless steel 18/10, for 4 slices of toast, hammered finish, six times polished

item	l x w x h in cm
2190	20x8.5x15



pastry tray

massive stainless steel 18/10, rectangular, hammered finish, six times polished

item	l x w in cm
2136	30x12.5



sushi tray "Longtray"

massive stainless steel 18/10, hammered finish, six times polished

item	l x w in cm
2160.66	66x8
2160.90	90x8



More etageres for china and glass are available on the following pages.



etagere

massive stainless steel 18/10, hammered finish, polished, 3 or 4 insertion levels (Ø inside: 6.5 cm) for plates/bowls with max. Ø 11 cm

item	l x w x h in cm	levels
2107.03	12.5x11.5x23	3
2107.04	12.5x11.5x29	4



New!

etagere with mini plates

set consists of:

etagere made of massive stainless steel 18/10, hammered finish, polished, with four insertion levels (Ø inside: 6.5 cm) for plates/bowls with max. Ø 11 cm
mini plate (5 pcs incl. 1 replacement plate), stoneware, black, matt, round, flat, Ø 10.5 cm
 1 set in black gift box

item	l x w x h in cm	PU
2106.04PB	12.5x11.5x29	1 set (6 parts)



2107.04 + 4606.10



2107.03 + 3954.08



2107.03 + 4240.10



2107.03 + 4324.11



2107.03 + 5443

Etageres

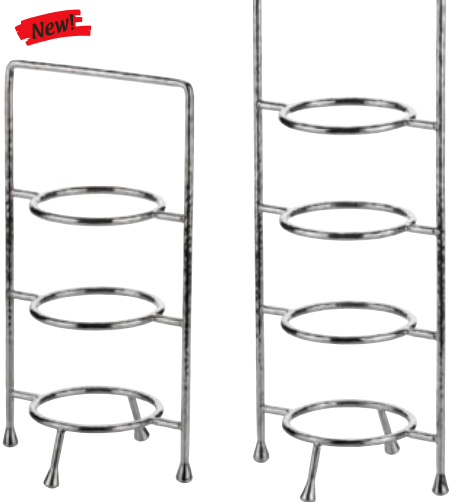

etagere
massive stainless steel 18/10, hammered finish, polished, 3 or 4 insertion levels (Ø inside: 10.8 cm) for plates/bowls with max. Ø 17.5 cm

item	l x w x h in cm	levels
2105.03	20.5x18x37.5	3
2105.04	20.5x18x47.5	4

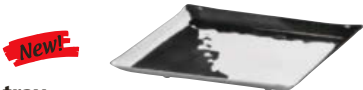

tray
massive stainless steel 18/10, square, with feet, hammered finish, six times polished

item	l x w x h in cm
2101.17	17.5x17.5x2.3



etagere with plates

set consists of:
etagere made of massive stainless steel 18/10, hammered finish, polished, with three insertion levels (Ø inside: 10.8 cm) for plates/bowls with max. Ø 17.5 cm

plate (4 pcs incl. 1 replacement plate), stoneware, black, matt, round, flat, Ø 17 cm
1 set in black gift box

item	l x w x h in cm	PU
2103.03PB	20.5x18x37.5	1 set (5 parts)



Elegantly served and presented in style - classic plate etageres, newly inspired!

Shapely and individual stands by Zieher are suitable for numerous applications. The classic plate etageres are available with three or four levels and in two sizes. Petit fours, desserts, chocolates or other delicacies are effectively presented by the classic mini format etageres.

The larger versions are perfectly suitable for scones and jam during Five O'Clock Tea, but also a choice of cold cuts, cheese or fruit can be staged elaborately on the set table. Numerous suitable inserts made of china, glass, stoneware and stainless steel are available on pages 270 and 271.



2105.03 + 4606.17



2105.03 + 2101.17



2105.03 + 5730.18



The glass bowls are available on page 76.



items 5329.25 (page 185) + 2141.01



buffet stand

massive stainless steel 18/10, highly polished

item	Ø in cm	height in cm
2141.01	25/20	13
2141.02	27/22	17.5
2141.03	29/25	23



bowl

massive stainless steel 18/10, oblique, hammered finish, six times polished

item	Ø in cm	height in cm
2174	38	7 / 15

items 8005.21 (page 53) + 2141.03



items 2174 + 2141.01



caviar set

glass, transparent, square, dimensions: big bowl 14x14x8.5 cm, 0.67 l content, small bowl 8x8x4.5 cm, 0.1 l content

item	l x w x h in cm	PU
5347	14x14x10	3 parts

items 2161 (page 90) + 2141.01



fruit/bread basket

massive stainless steel 18/10, square, highly polished, with base plate, stand for caviar set item 5347

item	l x w x h in cm
2168.15	15x15x15





buffet stand

massive stainless steel 18/10, round, made of polished round bars

item	Ø in cm	height in cm
2108.14	14	13
2108.19	19	17
2108.25	25.5	19



bowl

massive stainless steel 18/10, oblong, hammered finish, six times polished

item	l x w x h in cm
2184	62x15x7



buffet bowl "Lotus"

massive stainless steel 18/10, square, with horn-ball feet, hammered finish, six times polished

item	l x w x h in cm
2132	31x31x17

It is recommended to clean the horn-ball feet only with moist, soft tissues and non-abrasive substances. Cleaning in the dishwasher may damage the sealing.





buffet etagere

massive stainless steel 18/10, including five trays
item 2119.01 (66 cm long, 8 cm wide, 3 cm high),
hammered finish, six times polished

item	w x d x h in cm	PU
2119	66x54x32	6 parts

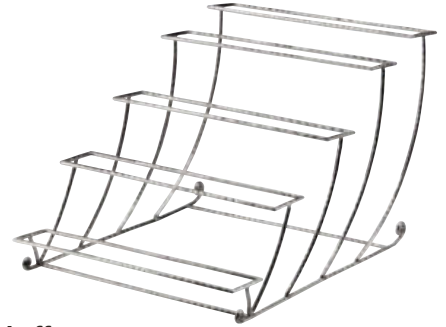

buffet etagere

massive stainless steel 18/10, delivery without trays
item 2119.01 (please order separately), hammered
finish, six times polished

item	w x d x h in cm
2119.02	38x54x31



tray with feet

massive stainless steel 18/10, rectangular,
hammered finish, six times polished, for
buffet etagere items 2119 and 2119.02

item	l x w x h in cm
2119.01	66x8x3



buffet platter

special hardened safety glass, rectangular, rounded
edges, polished rim, dishwasher-safe, rubber feet
included (adhesive), underside scratch-proof,
4 mm thick

item	version	l x w in cm
1668.12	black glass	66x10
1670.12	white glass	66x10



silicone sleeve

transparent, slotted alongside, for buffet etagere
items 2193, 2193.02, 2119 and 2119.02 (prevents
the slipping of glass platters)

item	length in mm	PU
4683	10	24 pcs

For the placement with glass platters we
recommend the use of non-slip silicone
sleeves (item 4683).





buffet etagere

massive stainless steel 18/10, including three trays item 2193.01 (62 cm long, 18 cm wide, 5 cm high), hammered finish, six times polished

item	w x d x h in cm	PU
2193	62x42x32.5	4 parts



buffet etagere

massive stainless steel 18/10, without trays item 2193.01 (please order separately), hammered finish, six times polished

item	w x d x h in cm
2193.02	46x42x31

Suitable trays made of glass are available on page 25.



tray with feet

massive stainless steel 18/10, rectangular, hammered finish, six times polished, for buffet etagere items 8013, 2193 and 2193.02

item	l x w x h in cm
2193.01	62x18x5



buffet platter

laminated plastic, rectangular, black intermediate ply, deburred edges, rounded corners, break-proof, scratch-proof, dishwasher-safe, antistatic, 8 mm thick

item	version	l x w in cm
8002.08	old varnish white	80x21
8003.08	rusted look	80x21
8006.08	dark grey	80x21



buffet platter

hardened glass, grey transparent, rectangular, irregularly coloured in a cloudy look, underside structured, dishwasher-safe, scratch-proof

item	l x w in cm	thickness in mm
8008.08	80x21	8



buffet platter

special hardened safety glass, rounded edges, polished rim, dishwasher-safe, rubber feet included (adhesive), underside scratch-proof, 4 mm thick

item	version	l x w in cm
1668.08	black glass	80x20
1670.08	white glass	80x20



buffet platter

hardened glass, rectangular, edges polished and deburred, 10 mm thick

item	version	l x w in cm
5243	transparent glass	80x21
5243.M	satined glass	80x21
5243.B	dark grey glass	80x21





holder coil shape

massive stainless steel 18/10, hammered finish, six times polished, for inserts made of china and glass

item	Ø in cm	total height in cm
2167.15	5.5	20
2167.20	5.5	25
2167.25	5.5	30
2167.30	5.5	35



marble platter

black/brown, polished surface, sides rough-textured, stainless steel feet, 24 bore holes (Ø 5 mm), for holder coil shape items 2167... or skewer items 1939.01/02 (please order separately)

item	l x w x h in cm
8052	45x31x5



Marble is a natural product. Please note the details on page 242.

marble platter

black/brown, rectangular, polished surface, sides rough-textured, 2.5 cm thick, feet of felt, not dishwasher-safe, for holder coil shape items 2167... or skewer items 1939.01/02 (please order separately)

item	version	l x w in cm
8022.01	2 holes	20x10
8022.02	3 holes	30x10



miniature

china, stackable, Ø 5.3 cm, 7 cm high, 0.1 l content

item	colour	PU
4490	white	6 pcs
4490.01	black	6 pcs



glass miniature

borosilicate glass, transparent, handblown, double-walled, with reinforced rim

item	Ø / height in cm	content in l	PU
4901.03	5.7 / 7.5	approx. 0.08	6 pcs

glass miniature "Amuse"

borosilicate glass, transparent, handblown, oval, single-walled

item	Ø / height in cm	content in l	PU
4912	6 / 7.5	approx. 0.11	6 pcs



skewer

stainless steel 18/10, 24 cm long

item	version	PU
1939.01	moon	12 pcs
1939.02	flame	12 pcs



dressing jar

massive stainless steel 18/10, double-walled, polished inside, hammered finish outside, six times polished

item	Ø in cm	height in cm	content in l
2176	14	15.5	1.5



spoon rest

massive stainless steel 18/10, rectangular, hammered finish, six times polished

item	l x w in cm
2154	18x10



tongs holder

massive stainless steel 18/10, hammered finish, six times polished, for tongs up to 24 cm length

item	l x w x h in cm
2115	27.5x9.5x28



spoon rest

massive stainless steel 18/10, six times polished

item	l x w x h in cm
2172	6.5x9.5x3.5



serving tongs

massive stainless steel 18/10, hammered finish, six times polished

item	length in cm
2139	28

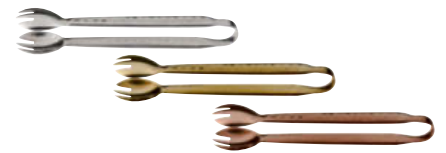

chocolate/ice cube tongs

massive stainless steel 18/10, hammered finish, six times polished, 19 cm long

item	version
2138	stainless steel
2138.G	stainless steel, golden
2138.C	stainless steel, copper



serving tongs

massive stainless steel 18/10, hammered finish, six times polished, 21.5 cm long

item	version
2140	stainless steel
2140.G	stainless steel, golden
2140.C	stainless steel, copper

The tongs have a thickness of 4 mm, they rest perfectly in the hand and convey a sense of quality!





dressing/jam jar
white china

item	Ø in cm	height in cm	content in l
4458	13.5	20	1.75



The complete "Mao" series is available on page 299.

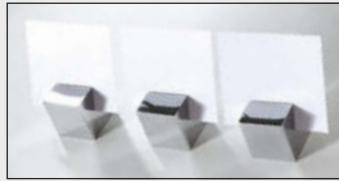

card holder

stainless steel 18/10, polished, with narrow slot, heavy quality

item	l x w x h in cm
3461	2.5x2.5x2.5



ashtray for cigars

optical glass, transparent, also usable as a rest for tongs or spoons, in black gift box

item	l x w x h in cm
5210	15x9x3



table display

white china, for self-labeling

item	l x w in cm	PU
4076	8x4.5	6 pcs



servers "Mao"

stainless steel 18/10, with black handles of resin, dishwasher-safe

item	version	length in cm
0493.21	salad set	28
0493.30	serving fork	27.5
0493.31	serving spoon	29
0493.40	soup ladle	30
0493.42	dressing ladle	29
0493.43	sauce ladle	22
0493.46	pie server	28

More dark grey glass platters are available on page 183.



servers "Goa"

stainless steel 18/10, with black handle of resin, dishwasher-safe

item	version	length in cm
0492.30	serving fork	27
0492.31	serving spoon	27



New!

spoon rest/glass miniature

dark grey, with spiral structure, 4 mm thick

item	l x w in cm	PU
5168.06	approx. 6.5x5	12 pcs

“Fingerfood-Tree”

Wildly bent tree branches supported by a base made of polished stainless steel: The fingerfood-trees by Zieher are absolutely delightful due to their extraordinary look and variable uses achieved by the different attachments!



A number of suitable attachments and applications offer a lot of possibilities and form the basis for the chef's imagination. The fingerfood-trees are perfect for patisserie creations, savory snacks in the form of mini-wraps or skewers, fruit with chocolate icing or just for jam at breakfast buffets. Furthermore they can be placed on both buffets and bar tables with the solid base ensuring stability.

This extraordinary way of presenting fingerfood will surprise and fascinate your guests and will definitely leave a lasting impression.

The fingerfood-trees are available in two sizes (height when bent: 90 cm and 120 cm) and are furnished with 30 branches, which in turn can be fitted with 5 suitable attachments (page 102). Besides a clip that holds wooden skewers and a spiral for small wraps and waffles, we offer rings in three sizes, the medium size of which is especially designed for holding small jam jars (e.g. Bonne Maman).

Velcro straps to fasten the branches and a stout carrier bag are available from the accessory section and allow easy transport and space-saving storage of the bent trees.



Design: Jochen Gromann



Equipped with ring size M the fingerfood-tree is perfectly suitable for presenting portion jam, e. g. Bonne Maman.



Design: Jochen Gromann



spring clip support

stainless steel 18/10, polished, to screw onto the "branches" of the fingerfood-tree items 8018...

item	length in cm	PU
8019.01	7	10 pcs

Ring size M is suitable for portion jam in conical glasses (e. g. Bonne Maman)



ring support

stainless steel 18/10, polished, to screw onto the "branches" of the fingerfood-tree items 8018...

item	size	Ø (inside) in cm	PU
8019.02	S	2.8	10 pcs
8019.03	M	3.8	10 pcs
8019.04	L	5.6	10 pcs



spiral support

stainless steel 18/10, polished, to screw onto the "branches" of the fingerfood-tree items 8018...

item	Ø in cm	height in cm
8019.05	4.5 / 2.0	4.5



For ring size S

glass cone

transparent, for cone stand items 2194...

item	Ø / height in cm	content in l	PU
5415	3.5 / 8	0.03	12 pcs



For ring size L

glass miniature

borosilicate glass, transparent, handblown, double-walled, with reinforced rim

item	Ø / height in cm	content in l	PU
4901.03	5.7 / 7.5	approx. 0.08	6 pcs



For spiral support

glass cloche

borosilicate glass, transparent, handblown, handmade

item	Ø in cm	approx. height in cm	PU
4982.05	5	8-9	6 pcs

"Fingerfood-Tree"

Please note:
The trees are being delivered with unbent branches; the bending has to be arranged before the first use!

The branches are made of stainless steel and will sag when loaded with food. This is why the branches should not be bent too far down when empty. In order to obtain a more favourable result, it is recommended to bend the branches one by one and to work in a circle from the outside to the inside.

The different attachments can be screwed onto the end of the branches, whereas the connection point should only be tightened up slightly. When using the rings or spiral, it is recommended to leave the connection point open by about half a turn, because they will turn into the apt position by themselves due to the weight of the attachments.



transport bag

polyester, black, with zip and 2 carrying straps, for fingerfood-tree items 8018...

item	l x w x h in cm
8018.T	150x29x29

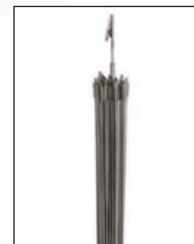

hook-and-loop strap

black, with chrome-plated clasp, for easy transport and space-saving storage of the fingerfood-tree items 8018...

item	l x w in cm
5660	43x2.5



fingerfood tree

stainless steel 18/10, polished, 20 short (87 cm) and 10 long (117 cm) "branches" of stainless steel wire, with 6 feet of felt, height after bending of "branches": approx. 110 - 130 cm, threaded ends for attachment of several supports items 8019... (please order separately)

item	Ø (foot) in cm	height unbent
8018.02	25	166 cm

fingerfood tree

stainless steel 18/10, polished, 30 "branches" of equal length (87 cm) of stainless steel wire, with 6 feet of felt, height after bending of "branches": approx. 90 - 110 cm, threaded ends for attachment of several supports items 8019... (please order separately)

item	Ø (foot) in cm	height unbent
8018.01	20	121 cm

"Mercato"



Integrated rubber feet guarantee stackability and safe standing.



The lateral cut-outs are suitable for buffet platters with a max. width of 21 or 34 cm.

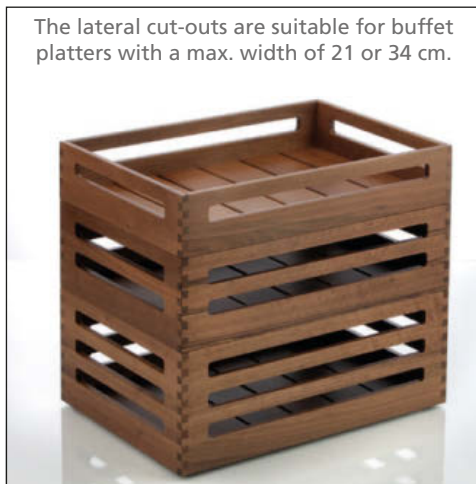

The bed tray is available on page 287.

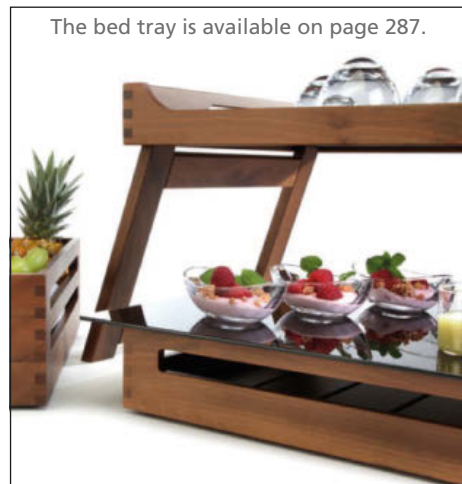

New!

buffet display/basket "Mercato"

walnut, food-safe sealed, stackable, not dishwasher-safe, with 4 rubber feet (screwed on)

item	l x w x h in cm
4768.08	43x30x8
4768.12	43x30x12
4768.16	43x30x16





The "Mercato" buffet baskets made of walnut are inspired by classic market boxes, but they are superior in many respects. Finger joints in the corners for maximum stability, solid walnut in modern design as well as deliberately chosen dimensions of the heights and lateral cut-outs offer numerous advantages. "Mercato" can be converted quickly and flexibly into a buffet display by the use of buffet platters. These platters (pages 52 to 61) can simply be laid on or pushed into the lateral cut-outs of the baskets (max. width 21 or 34 cm). In addition to the mere presentation of fruit or baked goods, "Mercato" is also ideal for the coffee break or for placing miniatures of any kind.

The integrated rubber feet ensure safe standing and guarantee the stackability of the baskets. Bread, rolls and pastries remain crisp and fresh longer, as the slotted bottom plates allow sufficient air circulation. The "Solid" bed tray is a nice addition to this system. Due to its integrated, foldable feet, it can do without risers for elevated positioning. For more information on the bed tray please see page 113, for the fitting "Solid" breakfast buffet please check pages 106 to 111.



Bread and more ...

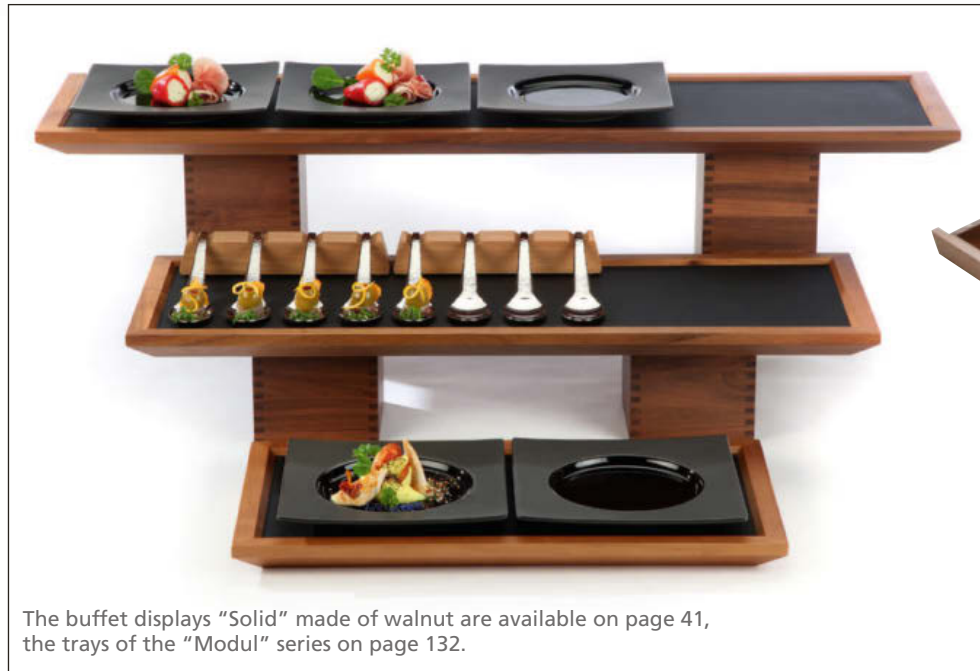

The buffet displays "Solid" made of walnut are available on page 41, the trays of the "Modul" series on page 132.



tray stand "Solid"

walnut, food-safe sealed, not dishwasher-safe, with 6 rubber feet and 16 anti-slip feet on the top side, for 2 serving trays "Solid" items 4707.PB and 4740

item	l x w x h in cm
4718	72.5x51x5 / 22



tray stand "Solid"

walnut, food-safe sealed, not dishwasher-safe, removable cover strip, with 6 rubber feet and 8 anti-slip feet on the top side, 2 pieces combinable with connector piece "Solid" item 4747 (for buffet setup of two pieces item 4746 one above the other), for 1 serving tray "Solid" items 4707.PB or 4740

item	l x w x h in cm
4746	42x51x5 / 13.5



The cutting board and the bridge "Solid" are available on pages 110 and 111.



connector piece "Solid"

walnut, food-safe sealed, not dishwasher-safe, for buffet setup of two pieces of the tray stand item 4746 one above the other, with 2 boreholes for wall mounting (optional, mounting material not included)

item	l x w x h in cm
4747	46.8x12x54.5





The presentation of bread is not only important at the table but at the breakfast buffet, too. The variety of baked goods wants to be put in the limelight.

Oblique displays for one or two wooden trays allow for a clear arrangement of various types of bread. With the help of a connector piece, two of these tray displays (item 4746) may be stacked and used on top of each other - the ideal solution for small buffet tables. A fitting cutting board including a crumb drawer and an exchangeable grate, a cutting board made of end grain wood as well as various bridges (to be found on pages 110 and 111) complete the series and provide the healthy and diversified breakfast with a new look.

Besides the flat bread tray you can also find a deeper version of that tray that is suited especially for the presentation of rolls, buns, biscuits and pastries. A removable grate provides air circulation, freshly baked buns remain scrumptious longer. Two kinds of divisions (for the tray) offer space for several miniatures (pages 263 and 264) and allow for a flexible use of the system. A cutlery insert for the deep tray as well as an insert for slices of toasted bread round off the range.

Wood from the European walnut tree, which is one of the most precious and most beautiful types of wood, forms the basis for this series. Both the wood's warm brown colours in different shades and its intensive and distinctive grain make every product a unique item!



Suitable miniatures in sizes 5 cm x 5 cm or 7 cm x 7 cm are available on pages 263 and 264.



More items of the "Solid" walnut series are available on pages 244 to 256. Not dishwasher-safe. Please note the attached care instructions.



Please order the glass inserts (items 1668.03 or 1670.03) separately.

servicing tray "Solid"

walnut, flat, food-safe sealed, not dishwasher-safe, with 2 recessed grips, with 4 rubber feet, in black gift box

item	l x w x h in cm	l x w (inside) in cm
4707.PB	53x37x4	50.2x34.2



tray insert "Solid"

walnut, food-safe sealed, not dishwasher-safe, divides the tray into 8 sections (length: 31.9 cm, width: 5.4 cm each), for serving trays "Solid" items 4707.PB and 4740 and miniatures with a max. width / Ø of 5 cm

item	l x w x h in cm
4742	50x34x2.9



tray insert "Solid"

walnut, food-safe sealed, not dishwasher-safe, divides the tray into 6 sections (length: 31.9 cm, width: 7.5 cm each), for serving trays "Solid" items 4707.PB and 4740 and miniatures with a max. width / Ø of 7 cm

item	l x w x h in cm
4743	50x34x2.9



glass platter

special hardened safety glass, rectangular, rounded edges, polished rim, dishwasher-safe, rubber feet included (adhesive), underside scratch-proof, 4 mm thick, for serving trays "Solid" items 4707.PB and 4740

item	version	l x w in cm
1668.03	black glass	50x34
1670.03	white glass	50x34

4707.PB + 1668.03



DESIGN
by
ZEHER

The tray stand/side table "Solid" is available on page 286.



4707.PB + 4741



4707.PB + 4743



4707.PB + 4742



4707.PB + 1670.03

"Solid"



servicing tray "Solid"

walnut, deep, food-safe sealed, not dishwasher-safe, with 2 recessed grips, with 4 rubber feet

item	l x w x h in cm
4740	53x37x10



The miniatures made of glass and china are available on pages 263 and 264.



4740 + 4745



tray insert "Solid"

walnut, food-safe sealed, not dishwasher-safe, divides the tray into 4 sections (length: 32 cm, width: 3x 13 cm and 1x 8 cm), for serving tray "Solid" item 4740

item	l x w x h in cm
4745	50x34x7



cutlery insert "Solid"

walnut, food-safe sealed, not dishwasher-safe, divides the tray into 4 sections (length: 24.9 cm, width: 11.2 cm each), for serving tray "Solid" item 4740 (for cutlery with a max. length of 24.7 cm)

item	l x w x h in cm
4744	50x27x7



grate insert "Solid"

walnut, food-safe sealed, not dishwasher-safe, with 9 rubber feet (6 mm high), for serving trays "Solid" items 4707.PB and 4740

item	l x w x h in cm
4741	49.8x33.8x2



4740 + 4741



4740 + 4744



4740 + 4743



4740 + 1670.03

Not dishwasher-safe, do not immerse in water!

"Solid"



bread cutting board "Solid"

walnut, oiled, not dishwasher-safe, with 4 rubber feet, with walnut grate (39.8 cm long, 24.3 cm wide, 1.8 cm high, exchangeable) and 18/10 stainless steel drawer for crumbs (with magnetic fixing)

item	l x w x h in cm
4733	48x32.5x4.3

Show cooking is a popular trend!

Whether using it for catering, at events or at the hotel's own buffet, the solid wood cutting boards by Zieher are pleasing eyecatchers and offer high functionality. The matching bridges can be equipped with bowls, putting everything tidily within reach for the work behind the buffet.

The dimensions of both, cutting boards and bridges, have been chosen in such a way that exactly two boards and two bridges would fit into a regular transportation box. This is extremely useful when it comes to storing the items for their daily use and transportation for catering purposes.

"Solid" is entirely made of walnut, the probably most beautiful and most stylish of the European woods.

More items from this series can be found on pages 244 to 257.



The changeable grate of the "Solid" cutting board has been constructed to protrude slightly from the cutting board to protect its rim.



replacement grate "Solid"

walnut, oiled, for bread cutting board "Solid" item 4733

item	l x w x h in cm
4733.R	39.8x24.3x1.8



cutting board "Solid"

walnut (end grain), oiled, not dishwasher-safe, with 4 rubber feet (screwed on), in black gift box

item	l x w x h in cm
4732. PB	48x32.5x4.8



Stackable in all usual transport boxes with the size of 60 cm x 40 cm (e. g. meat box, height approx. 20 cm)



bridge "Solid"

walnut, food-safe sealed, not dishwasher-safe, with 4 rubber feet

item	l x w x h in cm
4730	54x17x16



"Solid"



bridge "Solid"

walnut, food-safe sealed, with 3 tapered holes (Ø 12 cm top side/11 cm underside), not dishwasher-safe, with 4 rubber feet, for bowls with max. Ø 15 cm

item	l x w x h in cm
4731	54x17x12



DESIGN
by
ZIEHER

small bowl

glass, transparent, handblown, for stand for small bowls "TriBo" items 2025..., bridge "Solid" item 4731 and ring "SelectionA." items 4681... (please order separately)

item	Ø / height in cm	content in l	PU
5419.02	approx. 15 / 7.5/12	approx. 0.5	6 pcs



bowl "Shine"

stainless steel 18/10, outside polished, round/oblique, double-walled, Ø 15.7 cm, 6.7 / 8.8 cm high, 0.5 l content, for bridge "Solid" item 4731

item	colour inside
2260.16	satined (dishwasher-safe)
2261.16	ivory (not dishwasher-safe)
2262.16	taupe (not dishwasher-safe)



bowl "Catering de Luxe"

white china, for bridge "Solid" item 4731

item	Ø / height in cm	content in l	PU
4281	14 / 5.5/7.5	0.35	6 pcs



ham holder "Solid"

walnut (food-safe sealed), granite and massive stainless steel 18/10, not dishwasher-safe, with knife rest (for knives with a max. size of 43 cm x 3.5 cm)

item	l x w in cm
4749	50x26

Other kinds of wood upon request!
(custom built)



The porcelain pillows "Donna" are available on page 142.



DESIGN
by
ZIEHER



The cutting boards are pluggable and can be connected with each other.

"Connect!"

New!  GIFT BOX



Serving platters made of walnut!

Sublime in their appearance, unadorned in design, practical by compact formats and highly functional in combination - the solid wood boards of the series "Connect!" convince as a snack board, serving and cutting board, or as a presentation platter created by the combination of several elements. "Connect!" is an extremely versatile tool for everyday use. The integrated tenon in the shape of a dovetail serves as a decorative handle with an artisanal touch. Suitable cutouts at the underside allow an easy combination of different elements. Skid-proof positioning feet ensure a firm stand, the slanted outer edges facilitate handling. The solid walnut wood is sealed with high-quality oils which makes it easy to freshen up the surface from traces of everyday wear and tear.

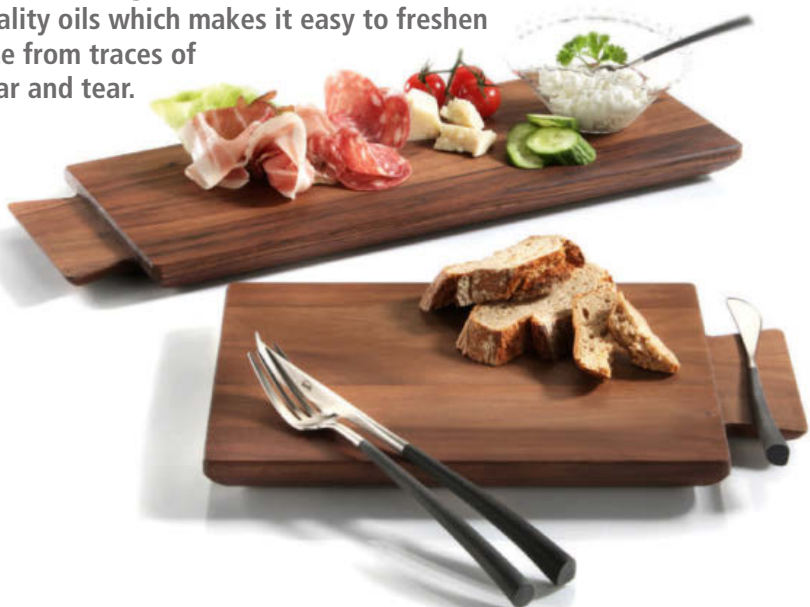

cutting/snack board "Connect!"

walnut, oiled, pluggable, not dishwasher-safe, with handle, with 4 rubber feet, in black gift box

item	l x w x h in cm	l incl. handle
4774.31PB	26.5x20x2.3	31 

New!  GIFT BOX



cutting/snack board "Connect!"

walnut, oiled, pluggable, not dishwasher-safe, with handle, with 4 rubber feet, in black gift box

item	l x w x h in cm	l incl. handle
4775.44PB	40x16x2.3	44.5 



box/tray "Solid"

walnut, food-safe sealed, not dishwasher-safe, with 4 rubber feet

item	l x w x h in cm	l x w (inside) in cm
4713	34x34x3	32x32



serving tray "Solid"

walnut, food-safe sealed, with 2 handles, not dishwasher-safe, with 4 rubber feet, utility space: 44.5 cm x 30 cm

item	l x w x h in cm
4706	50x30x5

The serving tray and suitable glass inserts are available on page 108, more "Solid" items on pages 244 to 257.





The roomservice tray as well as the new bed tray with feet stand out due to the precious walnut which is incorporated into these products with high-quality craftsmanship. The recessed longside enables comfortable dining directly off the tray. The retractable feet of the bed tray have been constructed in a very stable way and are securely kept in position by integrated magnets when folded in. The tray also cuts a good figure on the buffet. The positioning feet make it possible to dispense with the use of displays for heightened placing. A speedy set-up and flexible handling facilitate daily operations.



The tray stand for the roomservice tray item 4735 is available on page 286.

New!

bed tray „Solid“

walnut, with feet, food-safe sealed, not dishwasher-safe, stackable, with 2 handles, recessed on one side of the rim

item	l x w x h in cm closed	l x w x h in cm set up
4773.PB	60x40x6.5	approx. 74x40x31

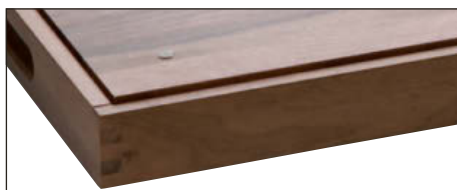

The rubber feet are set back from the rim to enable the transport in a tray trolley in 1/1 EN-format (60 cm x 40 cm).



roomservice tray "Solid"

walnut, food-safe sealed, not dishwasher-safe, stackable, with 2 handles, with 4 rubber feet, recessed on one side of the rim, suitable for tray stand "Solid" item 4748

item	l x w x h in cm
4735	60x40x5.4



„Solid“



Suitable tealight holders are available on page 280.



bread basket "Solid"

walnut, oblique, food-safe sealed, not dishwasher-safe

item	Ø in cm	height in cm
4760	13	10.5
4761	14	9



bowl "Solid"

walnut, food-safe sealed, not dishwasher-safe, round, stackable, with corrugated pattern outside

item	Ø in cm	height in cm
4711.18	18	6
4711.24	24	8
4711.30	30	10



4710 + 1669.33

serving tray "Solid"

walnut, food-safe sealed, not dishwasher-safe, round, stackable, with corrugated pattern outside

item	Ø in cm	height in cm
4710	36	4



dinner plate/glass insert

for serving tray "Solid" item 4710, special hardened safety glass, edge polished, dishwasher-safe, rubber feet included (adhesive), underside scratch-proof, 4 mm thick, Ø 33 cm

item	version
1669.33	black glass
1671.33	white glass



dinner plate/glass insert

for serving tray "Solid" item 4710, hardened glass, edge polished and deburred, 6 mm thick

item	Ø in cm
4999	33



The bread basket is available on page 251.





4591 + 4588



cutlery/napkin box

melamine, black, surface matt, with 4 rubber feet, food-safe, dishwasher-safe, not suitable for microwave and combi steam oven, for cocktail napkins folded to 1/8

item	l x w x h in cm	content in l	PU
4591	16x6x4.5	0.26	2 pcs



cutlery box

melamine, black, surface matt, food-safe, dishwasher-safe, not suitable for microwave and combi steam oven, for cutlery with a length of up to 23.5 cm

item	l x w x h in cm	PU
4594	26.5x16.2x7.2	4 pcs



cutlery box "Solid"

walnut, with acrylic glass lid, food-safe sealed, not dishwasher-safe, with 4 rubber feet, for cutlery with a length of up to 24.3 cm

item	l x w x h in cm
4720	26.5x16.2x8



buffet display "Solid"

walnut, food-safe sealed, not dishwasher-safe, bottom side open, can be used as a stand or as a container

item	l x w x h in cm	PU
4767.12	12x12x12	2 pcs
4767.24	12x12x24	2 pcs



4594 + 4589

The melamine GN tray item 4589 is available on page 122.



Grooves to let water from the dishwasher run off



The cutlery boxes item 4720 (wood) and 4594 (melamine) are stackable in all commercial transport boxes in format 60 cm x 40 cm.



The cutlery/napkin box for the table is available on page 248.

Each cloche on this page is handblown and handcrafted. In contrast to our cloches made of borosilicate glass (page 117), these items are made of a single massive glass drop. As a result there can be air inclusions and minor streaks which cannot be avoided. Each cloche is individual, the result is a harmonic enlivenment of the buffet for an attractive price.



More cloches made of glass and china are available on pages 187 to 195.



glass cloche

glass, transparent, with round handle, handblown, for saucer "Solid" items 4734...

item	Ø in cm	height in cm
4850	18.5	31
4851	22.5	37
4852	26	43



glass cloche

glass, transparent, suitable for pastry/cake stand items 5349...

item	Ø in cm	height in cm
5350.16	16	13
5350.23	23	16.5
5350.27	27.5	20.5



pastry/cake stand

transparent glass, with foot

item	Ø in cm	Ø foot in cm	height in cm
5349.21	21	10.5	9.5
5349.28	28	13	11.5
5349.33	33.5	13	11



Cloches made of borosilicate glass are heat resistant, dishwasher-safe and very easy to handle for the guests. The main features of this material are a great resistance against heat and changes in temperature as well as a high breakage resistance. Each item is manufactured by hand and therefore shaped individually.

glass cloche

borosilicate glass, transparent, handblown, handmade, for saucer "Solid" items 4734...

item	Ø in cm	height in cm
4880.18	18.5	approx. 29-32
4880.22	22.5	approx. 35-38
4880.26	26	approx. 41-44
4880.30	30	approx. 48-51



glass insert "Solid"

hardened glass, transparent, with 4 transparent silicone feet, edge polished and deburred, 4 mm thick

item	Ø in cm
5244.17	16.7
5244.21	20.7
5244.24	24.2
5244.28	28.2



saucer "Solid"

walnut, food-safe sealed, stackable, not dishwasher-safe, for glass cloche items 4850, 4851, 4852 and 4880... and glass inlay items 5244...

item	Ø / height in cm	for cloche / inlay
4734.01	23 / 3	Ø 18.5 / 16.7 cm
4734.02	27 / 3	Ø 22.5 / 20.7 cm
4734.03	30.5 / 3	Ø 26 / 24.2 cm
4734.04	34.5 / 3	Ø 30 / 28.2 cm



More cloches in different sizes are available on pages 189 to 193.



cloche with wooden saucer and glass insert

set consists of:

cloche made of borosilicate glass

insert made of hardened transparent glass (4 mm thick)

saucer made of walnut

1 set in black gift box

item	Ø in cm	height in cm	PU
4882.22PB	27	approx. 37-40	1 set (3 parts)
4882.30PB	34.5	approx. 50-53	1 set (3 parts)



"Choice"

This three-armed etagere is made of massive, high-grade stainless steel (18/10). Three arching arms provide a lot of potential to present objects. The bowls on the display are only some examples from a wide range of possibilities.



Please note:
The bowls are not included.

buffet etagere "Choice"

stainless steel 18/10, 3 arching arms with sockets to carry plates or bowls, round sockets Ø 16.5 cm, hexagonal base Ø 42 cm

item	height in cm
2022	50



glass bowl

transparent, round

item	Ø in cm	height in cm	content in l
5329.21	21.5	12.5	2.3
5329.25	25	15	3.5



bowl

glass, heavy quality, outside black, inside white

item	Ø in cm	height in cm	content in l
5364	18	9.5	1.3
5363	23	12.5	3.0



More sizes of the "Catering de Luxe" bowls are available on page 163.



bowl

granite, anthracite, fully polished

item	Ø in cm	height in cm
8034	18	7



bowl "Catering de Luxe"

white china

item	Ø / height in cm	content in l	PU
4281.02	19 / 7.5/10	1.0	6 pcs
4281.03	24 / 9.5/12.5	2.0	2 pcs



stand for small bowls "TriBo"

stainless steel 18/10, surface polished, with 3 round openings, for bowls with max. Ø 12 cm (item 2025.26), alternatively max. Ø 16.5 cm (item 2025.35)

item	Ø / height in cm	Ø openings in cm
2025.26	26 / 4.5	8.7
2025.35	35 / 5.5	11.2



The suitable silicone rings are available on page 230.



small bowl

glass, transparent, handblown, for stand "TriBo" items 2025... or for ring "SelectionA." items 4681... (please order separately)

item	Ø / height in cm	content in l	PU
5419.01	approx. 11.5 / 6/9	approx. 0.2	6 pcs
5419.02	approx. 15 / 7.5/12	approx. 0.5	6 pcs



jam/sugar bowl

glass, transparent, round, lid with notch for spoon, for stand "TriBo" item 2025.26

item	Ø / height in cm	content in l	PU
5425	9.8 / 7.5	approx. 0.18	6 pcs



bowl "Catering de Luxe"

white china, for stand "TriBo" item 2025...

item	Ø / height in cm	content in L	packing unit
4281.01	12 / 5/6.5	0.25	12 pcs.
4281	14 / 5.5/7.5	0.35	6 pcs.



glass bowl

transparent, round, for stand "TriBo" item 2025.35

item	Ø / height in cm	content in l	PU
5329.14	14 / 8.5	0.6	6 pcs



bowl

borosilicate glass, transparent, handblown, double-walled, for stand "TriBo" item 2025.26

item	Ø / height in cm	content in l	PU
4956.02	11 / 5.5	approx. 0.15	6 pcs

"TriBo"



DESIGN
by
ZIEHER



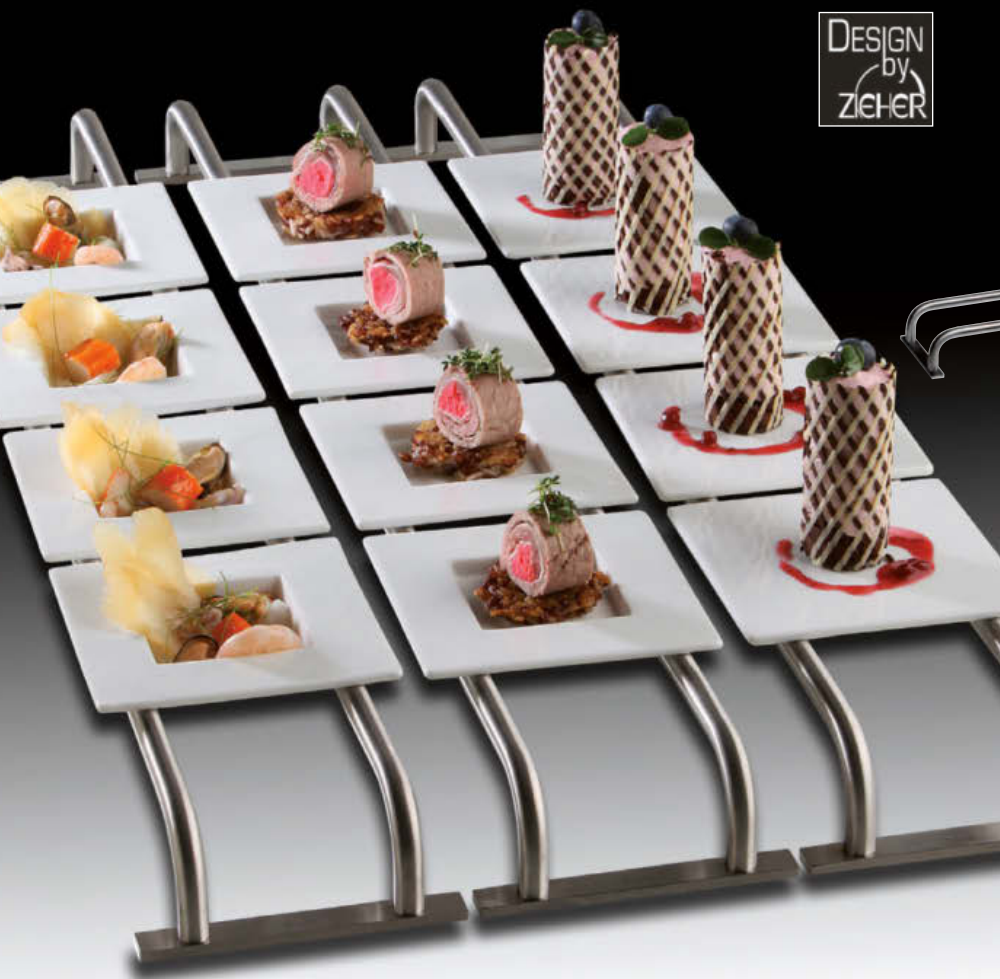

DESIGN
by
ZIEHER

“Move” sets your buffet into motion!

Front-cooking requires fast and fluent processes. Every buffet will stay neat and tidy with Zieher’s shapely sliding system “Move”.

The cook (or pastry cook) is able to equip the buffet with new portions from the back and the guests are able to help themselves from the front. There are no empty surfaces, no waiting for supplies and no obstruction of the guests - this is what “Move” is offering you.

The design originates from Tobias Greissing (www.greissing-design.de), whereas the underlying idea was developed by Pâtisserie Walter (www.patisserie.de). In cooperation with Zieher the system was made ready for the market. “Move” allows you unproblematic handling and provides your guests with a tidy and constantly filled buffet!

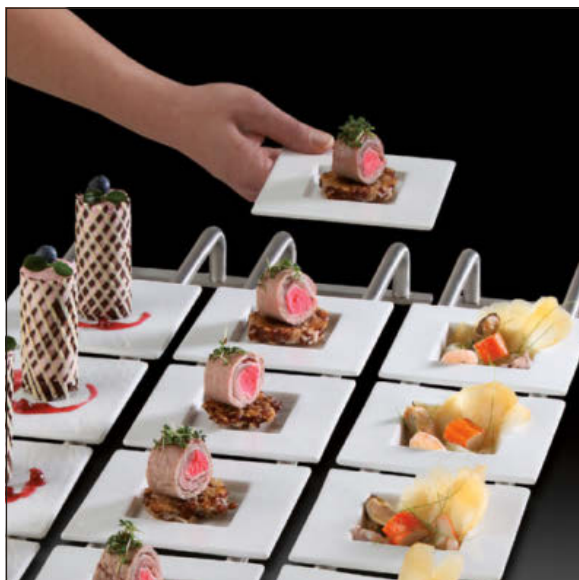

With three different “Move” dishes made of china featuring three different depths, food can be put directly onto these dishes or may be served in other small bowls/glasses that are presented in the “Move” dishes.

The rails are made of high-quality stainless steel and offer space for up to six bowls/plates. Furthermore, thanks to their length of 75 cm, they can be placed ideally on almost every buffet and their slip-resistant bases made of plastics guarantee safe stability.

“Move”



rail “Move”

stainless steel 18/10, with 4 black plastic feet

item	l x w x h in cm
2023	75x12.5x5.3

platter “Move”

white china, with foot (6.8 cm x 6.8 cm), useable as plate for rail “Move” item 2023

item	l x w x h in cm	PU
4463	12x12x1	6 pcs

small bowl “Move”

white china, flat, with foot (6.8 cm x 6.8 cm), useable as small bowl for rail “Move” item 2023

item	l x w x h in cm	PU
4464	12x12x1.4	6 pcs

small bowl “Move”

white china, deep, with foot (6.8 cm x 6.8 cm), useable as small bowl for rail “Move” item 2023

item	l x w x h in cm	PU
4465	12x12x3	6 pcs



The buffet displays “Konkret!” are available on pages 46 to 48.

Catering





DESIGN
by
ZIEHER



Cavities on the bottom of the frames enable not only the use of 1/1 GN trays, but also the use of trays in the formats 1/2 GN and 1/3 GN.

The table spoon "Goa" is available on page 300.

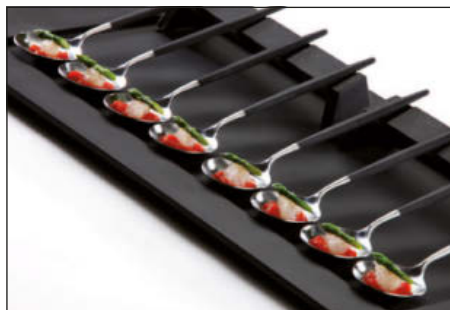

GN tray

melamine, black, surface matt, food-safe, dishwasher-safe, not suitable for microwave and combi steam oven

item	l x w x h in cm	GN	PU
4587	32.5x17.6x1.8	1/3	2 pcs
4588	32.5x26.5x1.8	1/2	2 pcs
4589	53x32.5x1.8	1/1	2 pcs

Suitable inserts are available on page 139.



stacking frame

melamine, black, surface matt, food-safe, dishwasher-safe, for melamine trays items 4587, 4588, 4589, not suitable for microwave and combi steam oven

item	l x w x h in cm	PU
4592	51.5x31.5x6.5	2 pcs



spoon rest "Modul"

melamine, black, surface matt, with 4 rubber feet (black), food-safe, dishwasher-safe, not suitable for microwave and combi steam oven

item	l x w x h in cm	PU
4585	20x5x4	2 pcs



bridge "Modul"

melamine, black, surface matt, 5 graded sockets (Ø top 5 cm, Ø bottom 2.5 cm), for several glass items (5257, 5405, 5413,...), with 4 rubber feet (black), food-safe, dishwasher-safe, not suitable for microwave and combi steam oven

item	l x w x h in cm	PU
4584	41.5x7.7x6	2 pcs



Idea and concept: Thomas Dötzer, Dötzer Restauration, Bayreuth, Germany (www.doetzers.de)

The "Cater-Log" frame with its fitting trays in GN-format offers modern looks as well as several advantages for the everyday use in catering:

- Pleasant design
- Hygienic transportation of prepared dishes (for flying buffet)
- Stackable frames, usable as buffet display as well
- Several presentation levels, implemented easily and quickly
- Variable use due to different tray sizes



Robust & elegant - melamine!



tray

melamine, black, surface matt, food-safe, dishwasher-safe, not suitable for microwave and combi steam oven

item	l x w x h in cm	PU
4586	25.2x13.2x1.8	2 pcs



2/8 GN tray

melamine, black, surface matt, with 3 round sockets (Ø 5.5/8.2 cm), food-safe, dishwasher-safe, not suitable for microwave and combi steam oven

item	l x w x h in cm	PU
4590	32.5x13.2x1.8	2 pcs

Thanks to the different depths and diameters of the holes, the tray item 4590 can be used with inserts up to a bottom diameter of 5.5 cm and 8.2 cm.

Here is a selection of suitable products:



creamer

white china, stackable

item	Ø / height in cm	content in l	PU
4489	5.3 / 9	0.13	6 pcs



miniature

china, stackable, Ø 5.3 cm, 7 cm high, 0.1 l content

item	colour	PU
4490	white	6 pcs
4490.01	black	6 pcs



glass miniature

borosilicate glass, transparent, handblown, double-walled

item	Ø / height in cm	content in l	PU
4903	5.5 / 8.5	approx. 0.1	6 pcs



glass bottle

with swing top (PVC lid), height incl. swing top

item	Ø / height in cm	content in l	PU
5290.02	5.5 / 19	0.2	12 pcs



glass

item	Ø / height in cm	content in l	PU
5380	7.5 / 10.5	0.32	6 pcs
5381	7.5 / 6	0.18	6 pcs



- Modern design with matt-black surface
- Dishwasher-safe
- Food-safe
- Odourless
- Easy-care



The table spoon "Goa" is available on page 300.



small bowl "Catering"

white china

item	Ø / height in cm	content in l	PU
4499	8 / 5.5	0.2	6 pcs
4500	8 / 2.5	0.08	12 pcs



small bowl

white china

item	Ø / height in cm	content in l	PU
4498	8 / 6	0.17	6 pcs



glass miniature

glass, Ø 8 cm, 5 cm high, 0.13 l content

item	version	PU
5420	transparent	6 pcs
5420.01	satined	6 pcs



small bowl "Halfmoon"

borosilicate glass, transparent, handblown, double-walled

item	Ø / height in cm	content in l	PU
4954.02	8 / 9	approx. 0.17	6 pcs



glass tumbler

borosilicate glass, transparent, handblown, double-walled

item	Ø / height in cm	content in l	PU
4907	8 / 10	approx. 0.28	6 pcs



tray

melamine, black, surface matt, with 3 oval sockets (diagonal), food-safe, dishwasher-safe, not suitable for microwave and combi steam oven, for small bowls items 4081.12 (china) and 5444 (glass)

item	l x w x h in cm	PU
4593	32.5x13.2x1.8	2 pcs



bowl

white china, oval

item	l x w x h in cm	content in l	PU
4081.12	12.5x7.5x4	0.1	12 pcs



bowl

glass, transparent, oval

item	l x w x h in cm	content in l	PU
5444	12.5x7x4	0.08	6 pcs



items 4593 + 4081.12



Trays made of black glass and suitable inserts are available on pages 276 and 277.



Please note: items made of melamine are not to be used for cooking in microwave and combi steam oven!

The melamine GN tray item 4589 is available on page 122.

items 4594 + 4589



items 4591 + 4588 (page 122)



cutlery/napkin box

melamine, black, surface matt, with 4 rubber feet, food-safe, dishwasher-safe, not suitable for microwave and combi steam oven, for cocktail napkins folded to 1/8

item	l x w x h in cm	content in l	PU
4591	16x6x4.5	0.26	2 pcs

Grooves to let water from the dishwasher run off



cutlery box

melamine, black, surface matt, food-safe, dishwasher-safe, not suitable for microwave and combi steam oven, for cutlery with a length of up to 23.5 cm

item	l x w x h in cm	PU
4594	26.5x16.2x7.2	4 pcs



cutlery box "Solid"

walnut, with acrylic glass lid, food-safe sealed, not dishwasher-safe, with 4 rubber feet, for cutlery with a length of up to 24.3 cm

item	l x w x h in cm
4720	26.5x16.2x8



The cutlery boxes item 4720 (wood) and 4594 (melamine) are stackable in all commercial transport boxes in format 60 cm x 40 cm.



The cutlery/napkin box for the table is available on page 248.

VISION from page 203 onwards



tray "Slope"

melamine, matt, rectangular (oblique), stackable, utility space: approx. 26 cm x 15.5 cm

item	colour	l x w x h in cm	PU
4595.30	black	30x19.5x4.2	3 pcs
4596.30	white	30x19.5x4.2	3 pcs



tray "Slope"

melamine, matt, rectangular (oblique), stackable, utility space: approx. 40 cm x 24 cm

item	colour	l x w x h in cm	PU
4595.45	black	45x29x4.2	2 pcs
4596.45	white	45x29x4.2	2 pcs

tray "Slope"

in black gift box

item	colour	l x w x h in cm	PU
4595.45PB	black	45x29x4.2	1 pc.
4596.45PB	white	45x29x4.2	1 pc.



"Slope"



item 4595.30

The melamine tray "Slope" is characterised by its unobtrusive shaping and the pleasant feel of the matt and finely structured surface. An elevated corner and the resultant asymmetry award the tray that certain something.

Besides the obvious function as a service tray for espresso, cocktails, snacks and more it also performs well in the hotel bathroom or as a decorative trivet in the hotel room.

"Slope" is available in a black and a white version and in two sizes. The robust raw material melamine appears very elegant due to its matt surface and of course it complies with demands of everyday use like food safety, dishwasher resistance as well as stackability.



Zieher and livecookintable® have started a cooperation for the "Modul" series (pages 131 to 139), the catering system by Zieher. Livecookintable® has developed fitting displays to integrate "Modul" perfectly into this innovative table system and to maximise the advantages of both product lines.

ZIEHER

livecookintable®

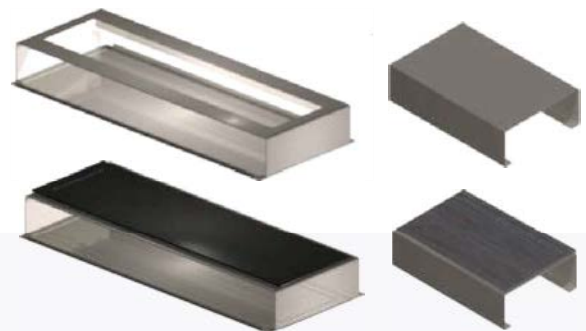

The livecookintable® system offers:

- The system solution for gastronomy
- A portable cooking system with exchangeable modules for cooking, barbecue, heating, cooling, etc.
- The first livecooking device with a carrier bag
- Simple and intuitive handling
- Easy setup without tools

livecookintable Zieher Displays:

livecookintable food bridge + display, suitable for Zieher tray and china series "Modul" (pages 131 to 139).

RESTAURANT

ASIAN
FUSION

WESTERN
GRILL

PASTA
PASTA

BU



■ **livecookintable®**



livecookintable® multistation:

With the livecookintable® multistation a versatile product has been developed. It is suitable for the combined use with the product series "Solid" (pages 108 to 110), "Modul" (pages 131 to 139) as well as with the melamine trays (pages 121 to 126) by Zieher. Whether it is used to shelve china, to serve coffee, tea or bread or as a cutting station, this multistation and Zieher offer an unlimited multitude of possibilities.



Discover all facets of the livecookintable® system: www.livecookintable.com

ZIEHER

FFET

SUSHI +
YAKI

CHINA
DIM SUM

BAR

RECEPTION DESK



Non-slip covers in matt black: Classy look - great benefit!



In connection with the trays made of walnut, the matt black look and the velvety texture, these mats create an interesting contrast. In combination with the "Modul" melamine trays, they become almost invisible.

The mats made of food-safe silicone are extremely skid-proof and facilitate the serving considerably. No clattering, no shifting of porcelain bothers guests and staff!

To clean the mats, please use a moist cloth with some detergent and wipe off with a cloth and clear water.



Non-slip coasters for single miniatures are available on page 210.



The sizes of the mats perfectly fit the walnut trays items 4721, 4722 and 4723. With a sharp cutter knife the mats can be adjusted in size to fit the same sized melamine trays items 4581, 4582 and 4583. We recommend the use of a cutting board and a steel ruler.



non-slip mat

silicone, black, temperature resistant (-40 °C - +230 °C), food-safe, for walnut trays "Modul" items 4721, 4722 and 4723, can be cut to fit melamine trays "Modul" items 4581, 4582 and 4583

item	l x w in cm	PU
4660.01	42.6x20.6	6 pcs
4660.02	65.5x20.6	6 pcs
4660.03	87.6x20.6	6 pcs

“Modul”



“Modul” is a flexible product ready for “Flying Buffet” service - and therefore ideally suited for use in the catering area. The slim, oblong format of the base tray, which is available in three sizes, renders the often cumbersome service at crowded standing receptions barrier-free and uncomplicated. The trays can be variably fitted with glass or porcelain parts, a bridge for glasses or a wooden spoon bench for 4 spoons. When using two spoon benches together, 4 long skewers can be placed safely on top. Every single piece has been specially developed for this catering system. Trays, bridge and spoon rest are available in 2 variations: The series “Modul” is manufactured from walnut wood, which is probably the most precious of all European hardwoods (pages 132 and 133) and from melamine in a modern matt-black design (pages 134 and 135). Suitable miniatures made of china and glass (pages 136 to 139) can be fitted to all trays! Shapely anti-slip mats made of silicone (see left page) facilitate catering to a great extent.

Play upon a variety of possibilities!

"Modul" - walnut

Wood from the European walnut tree, which is one of the most precious and most beautiful types of wood, forms the basis for this series. Both the wood's warm brown colours in different shades and its intensive and distinctive grain make every product a unique item. The high-quality workmanship in combination with the food-safe sealing guarantees long durability, even in everyday use.



The party spoon items 1938... are available on page 240.



base tray "Modul"

walnut, food-safe sealed, not dishwasher-safe, stackable

item	l x w x h in cm
4721	47.5x25.5x3.1
4722	70x25.5x3.1
4723	92.5x25.5x3.1



The finger-groove on the bottom side of the tray guarantees safe and simple handling.



bridge "Modul"

walnut, food-safe sealed, not dishwasher-safe, with 5 graded sockets (Ø top 5 cm, Ø bottom 2.5 cm), with 4 rubber feet

item	l x w x h in cm
4724	42.5x9x6.5



spoon rest "Modul"

walnut, food-safe sealed, not dishwasher-safe, with 4 rubber feet

item	l x w x h in cm
4725	21x3.2x3.8



Suitable inserts for the bridge "Modul" are available on page 139.



buffet display "Solid"

walnut, food-safe sealed, not dishwasher-safe, bottom side open, can be used as a stand or as a container

item	l x w x h in cm	PU
4767.12	12x12x12	2 pcs
4767.24	12x12x24	2 pcs

“Modul” - walnut



- European walnut
- Warm shades of brown with vivid grain
- High-quality workmanship
- Finger-groove on the bottom side guarantees safe and simple handling



"Modul" - melamine

The advantages of melamine are manifold. It is dishwasher-safe and food-safe, which becomes evident in daily catering use! The smallest tray is 53 cm long and is therefore partially compatible with existing GN-systems. All trays are stackable.

Besides the merely technical properties, the flat black trays differ from the variant made of walnut by their modest design and comfortable haptic.

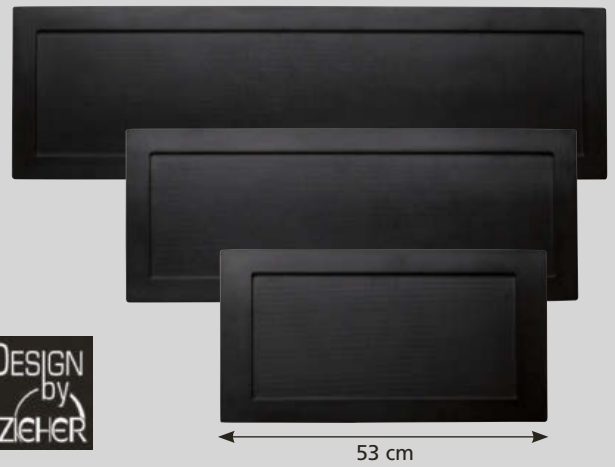

DESIGN
by
ZIEHER

base tray "Modul"

melamine, black, surface matt, food-safe, dishwasher-safe, not suitable for microwave and combi steam oven

item	l x w x h in cm	PU
4581	53x28x1.8	2 pcs
4582	72.5x28x1.8	2 pcs
4583	95.5x28x1.8	2 pcs



The grooves at the bottom side of the tray let water from the dishwasher run off.



bridge "Modul"

melamine, black, surface matt, 5 graded sockets (Ø top 5 cm, Ø bottom 2.5 cm), for several glass items (5257, 5405, 5413,...), with 4 rubber feet (black), food-safe, dishwasher-safe, not suitable for microwave and combi steam oven

item	l x w x h in cm	PU
4584	41.5x7.7x6	2 pcs



spoon rest "Modul"

melamine, black, surface matt, with 4 rubber feet (black), food-safe, dishwasher-safe, not suitable for microwave and combi steam oven

item	l x w x h in cm	PU
4585	20x5x4	2 pcs



The bowl "Modul" is available on page 136.



The table spoon "Goa" is available on page 300.



The party spoon items 1938... are available on page 240.



Suitable inserts for the bridge are available on page 139.



“Modul” - melamine

- Modern design with matt-black surface
- Dishwasher-safe
- Food-safe
- Odourless
- Easy-care



The buffet stands “Lightning Buffet” are available on page 38.

“Modul” - versions



walnut



bowl “Modul”

white china, deep, lengthwise, for base trays
“Modul” made of walnut and melamine

item	l x w in cm	content in l	PU
4384	22x11	0.22	12 pcs



walnut



bowl “Modul”

white china, square, deep, for base trays
“Modul” made of walnut and melamine

item	l x w in cm	content in l	PU
4381	11x11	0.07	12 pcs

non-slip mat (page 130)



walnut



plate “Modul”

white china, square, flat, for base trays
“Modul” made of walnut and melamine

item	l x w in cm	PU
4380	11x11	12 pcs

non-slip mat (page 130)



walnut



plate “Modul”

white china, flat, item 4385.22 fits base trays
“Modul” made of walnut and melamine

item	l x w in cm	PU
4385.22	22x22	6 pcs
4385.27	27x27	4 pcs



plate "Modul"

white china, flat, lengthwise, for base trays
"Modul" made of walnut and melamine

item	l x w in cm	PU
4383	22x11	12 pcs



glass plate "Modul"

deep black, flat, lengthwise, for base trays
"Modul" made of walnut and melamine

item	l x w in cm	PU
5074.03	22.5x11	6 pcs



glass plate "Modul"

frosted look, flat, lengthwise, for base trays
"Modul" made of walnut and melamine

item	l x w in cm	PU
5074.02	22.5x11	6 pcs



glass plate "Modul"

transparent, flat, lengthwise, for base trays
"Modul" made of walnut and melamine

item	l x w in cm	PU
5074.01	22.5x11	6 pcs



The amuse-gueule/tapas spoon
item 4260.01 is available on page 240.

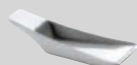

amuse-gueule/tapas spoon "Modul"

white china

item	l x w x h in cm	PU
4260.03	10x4x2.2	12 pcs



melamine



melamine



melamine



melamine with
non-slip mat (page 130)



walnut



melamine with non-slip mat (page 130)



melamine



melamine



melamine

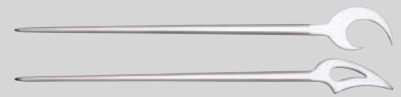

skewer

stainless steel 18/10, 24 cm long

item	version	PU
1939.01	moon	12 pcs
1939.02	flame	12 pcs

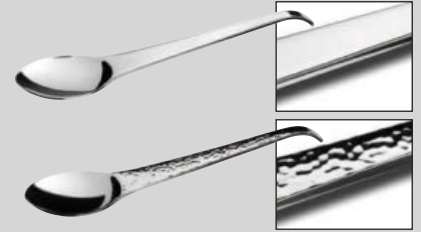

party spoon

stainless steel 18/10, heavy quality, 4.3 mm thick, 21 cm long

item	version
1938	polished
1938.01	hammered finish



table spoon “Goa”

stainless steel 18/10, handle of resin, dishwasher-safe

item	length in cm	PU
0492.01	21	12 pcs



spoon rest “Modul”

melamine, black, surface matt, with 4 rubber feet (black), food-safe, dishwasher-safe, not suitable for microwave and combi steam oven

item	l x w x h in cm	PU
4585	20x5x4	2 pcs



cutlery/napkin box

melamine, black, surface matt, with 4 rubber feet, food-safe, dishwasher-safe, not suitable for microwave and combi steam oven, for cocktail napkins folded to 1/8

item	l x w x h in cm	content in l	PU
4591	16x6x4.5	0.26	2 pcs



glass bowl

borosilicate glass, flat

item	Ø / height in cm	content in l	PU
4910	10.5 / 2.5	0.18	12 pcs



glass

transparent, for bridges "Modul" items 4584 and 4724

item	Ø / height in cm	content in l	PU
5405	5 / 8.6	0.1	6 pcs



glass

transparent, reinforced foot (ring Ø 4.6 cm), for bridges "Modul" items 4584 and 4724

item	height in cm	content in l	PU
5413	9.5	0.07	12 pcs



dessert glass

transparent, for bridges "Modul" items 4584 and 4724

item	Ø / height in cm	content in l	PU
5257	7 / 10	0.08	12 pcs



glass miniature

transparent, wavy rim, base: 0.07 l content, top part: 0.04 l content, for bridge "Modul" items 4584 and 4724

item	version	Ø / height in cm	PU
5423.01	base	6.5 / 5.5	12 pcs
5423.02	top	6.3 / 4.5	12 pcs



test tube

borosilicate glass (temperature change resistant), with flanged rim and round bottom, suitable for holder for test tube items 4680... and cork item 1501

item	content in l	PU
4032.G	0.04	24 pcs



cork

for test tube item 4032.G

item	Ø in cm	length in cm	PU
1501	2.0/1.7	2.6	24 pcs



holder for test tubes

silicone, with grooves on the inside for easy insertion of glass tubes, Ø 4.6 cm, 2.7 cm high, for test tube item 4032.G

item	colour	PU
4680.S	black	6 pcs
4680.W	white	6 pcs



walnut with non-slip mat (page 130)

The "Modul" base trays made of walnut and melamine combine well with many Zieher items from the same series and beyond. Here are some suggestions:

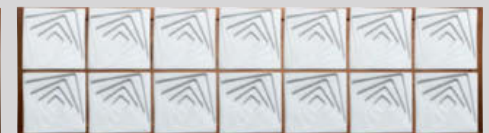

small bowl

white china, square

item	l x w x h in cm	content in l	PU
3853	7x7x2	0.05	12 pcs



dip bowl "Twist" for olive oil

white china

item	l x w x h in cm	PU
3912	12x12x1.8	6 pcs



walnut



small bowl

square, 4.9 cm long, 4.9 cm wide, 4.5 cm high, 0.05 l content

item	version	PU
3845	china	4 pcs
5254	glass	4 pcs



miniature platter

white china

item	l x w in cm	PU
4072.M	13x6	12 pcs



The buffet systems by Zieher were developed to put the most exquisite products in the limelight in a very effective and diversified way.



The section "displays" shows that they are not limited to the use with food: high-class jewellery and watches, as well as other kinds of luxury goods find a representative stage with the Zieher display systems.

The discreet and classy design never pushes for attention but offers a unique and distinctive means of presentation that puts the product at the centre of attention.

Contact: display@zieher.com

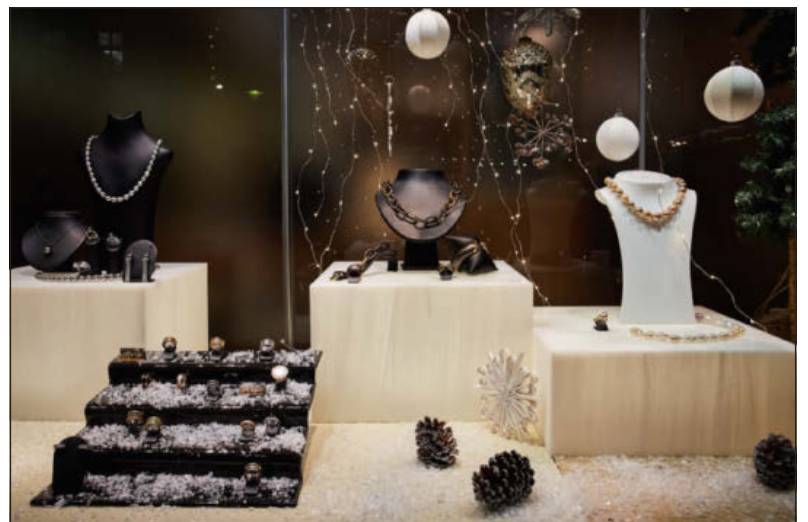

Photo: www.juwelier-hohenberger.de

China, glass and more!



“Donna”

Bedded on china,



These elegant porcelain-pillows “Donna”, which are inspired by a woman’s curved back, are definitely not made to sleep on but offer an ideal presentation area for high-end dishes or present a sculptural place to keep various items of everyday life. Even when used as a soap dish, the medium pillow made of glass or porcelain cuts a fine figure. The version made of porcelain is available in three sizes and stages every dish and surprises the guest. Especially the two small pillows can be used perfectly on the buffet and offer an exciting contrast to conventional forms of glass or china.

Platters and dinner plates made of hardened black glass are available on page 58.



porcelain pillow “Donna”

white, items 4461.02 and 4461.02PB: not dishwasher-safe

item	l x w x h in cm	PU
4461.03	12.3x8x2.7	12 pcs
4461.01	16.5x11x3.5	6 pcs
4461.02	33x22x7	1 pc.

porcelain pillow “Donna”

in black gift box

item	l x w x h in cm	PU
4461.01PB	16.5x11x3.5	1 pc.
4461.02PB	33x22x7	1 pc.

glass or wood!

"Donna"



New

glass pillow "Donna"

glass, satined, in black gift box

item	l x w x h in cm	
5446.01PB	16.5x11x3	



New

wooden pillow "Donna"

solid walnut, oiled, not dishwasher-safe, 4 rubber feet, in black gift box

item	l x w x h in cm	
4772.33PB	33.5x22.5x7	

The new variants of the "Donna" pillows are made of frosted glass and oiled walnut and despite their hard and massive raw materials they surprises by their pleasantly soft and velvety feel. One just has to touch the softly curved forms of this hand charmer. The version made of solid walnut, one of the finest European types of wood, has its own appearance. The sealing with oils emphasizes the striking grain of the wood and gives the surface a silk-matt gloss as well as amazing haptics. Whether used as a fruit bowl, as a place to keep accessories or as sculptural decoration - "Donna" seduces in every material!



Please note the care instructions: not dishwasher-safe, do not immerse in water (item 4772.33PB)!

"Cuspis"



glass cloche "Cuspis"

borosilicate glass, transparent, handblown, star-shaped ball handle

item	for plate/bowl	Ø in cm	height in cm
4940.08	4389.09	8.5	12.5
4940.10	4389.11	10.5	14.5
4940.25	4389.25PB	25	32.5



plateau plate/small bowl "Cuspis"

white china, inside and useable area (plateau Ø approx. 6 cm/8 cm) glazed, outside biscuit, also useable as a bowl

item	Ø in cm	height in cm	content in l
4389.09	9	3	0.1
4389.11	11.5	3.5	0.18

The honey spoon "Cuspis", here used as a skewer, is available on page 212.

The dark grey glass platters are available on page 76, the glass spoon "Cuspis" on page 212.



plateau plate/bowl "Cuspis"

white china, inside and useable area glazed, outside biscuit, useable on both sides, for cloches items 4940.25 and 4940.10 (bottom side), in black gift box

item	Ø in cm	height in cm	content in l
4389.25PB	25	2.8	0.8



cloche with plateau plate "Cuspis"

set consists of:
cloche made of borosilicate glass, transparent, handblown, with star-shaped ball handle
plateau plate made of white china, inside and useable area glazed, outside biscuit, useable on both sides

item	Ø in cm	height in cm	PU
4943.08PB	9	approx. 14/14.5	1 set (2 parts)
4943.10PB	11.5	approx. 17/17.5	1 set (2 parts)
4943.25PB	25	approx. 33/35	1 set (2 parts)



"Cuspis"

Borosilicate glass in its most beautiful shape!

The primary design element of the series "Cuspis" is a glass ball studded with fine spikes. The cloches with fitting porcelain plateau plates/bowls are available in three sizes and the inspiration for their shaping was derived from the nut of the oak tree. The star-shaped handle is located at the top of the cloches and allows for an uncomplicated handling of these classy covers. The unglazed outside of the porcelain bowls is reminiscent of acorn caps. The bowls can be used on both sides. When used as a plateau plate, the dishes move closer to the guest. Used as a bowl, it offers space for gravies, sauces and more while the filigree glass cloche protects the presented delicacies and puts them in the limelight at the same time. Shapely amuse-gueule spoons as well as an extraordinary honey spoon, which can also be used as a skewer, complete the "Cuspis" series. These items are available on page 212.



If the item is used upside down as a plate, the two rings on the plate's underside can be used to separate the prepared dish into different sections and the cloches of the "Cuspis" series may also be used with it (4940.10 on the inner ring, 4940.25 on the outer ring).



items 4389.25PB + 4940.10



plate "Rough!"

white china, glossy, round, structured surface

item	Ø in cm	PU
4566.24	24	4 pcs
4566.27	27	4 pcs

"Rough!"

Non-slip coasters are available on page 210, the creamers made of borosilicate glass on page 220.



platter "Rough!"

white china, glossy, square, structured surface

item	L x B x H in cm	PU
4569.12	12x12x1	4 pcs
4569.23	23x23x1	4 pcs
4569.27	27x27x1	2 pcs

The glass bowl "Spobo" is available on page 164.

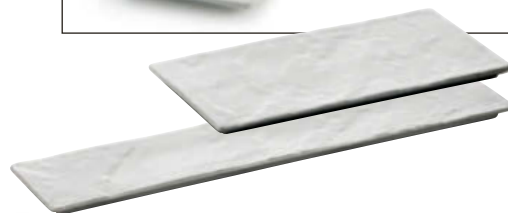

platter "Rough!"

white china, glossy, rectangular, structured surface

item	l x w x h in cm	PU
4568.23	23.5x11x1	4 pcs
4572.36	36x7.5x1	4 pcs





plate "Rough!"

china, black, matt, round, structured surface

item	Ø in cm	PU
4567.24	24	4 pcs
4567.27	27	4 pcs



platter "Rough!"

china, black, matt, square, structured surface

item	l x w x h in cm	PU
4571.12	12x12x1	4 pcs
4571.23	23x23x1	4 pcs
4571.27	27x27x1	2 pcs

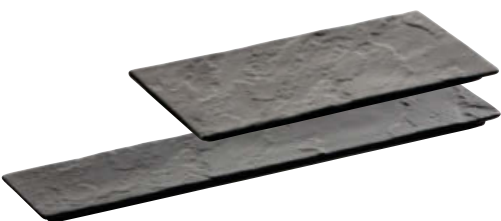

platter "Rough!"

china, black, matt, rectangular, structured surface

item	l x w x h in cm	PU
4570.23	23.5x11x1	4 pcs
4573.36	36x7.5x1	4 pcs



The creamer made of glass is available on page 229.

The glass miniature is available on page 225.



Modest design combined with distinctive surfaces in matt black and glossy white - "Rough!" is the perfect basis for the presentation of exclusive dishes.



"Velo"

DESIGN
by
ZEHER



plate "Velo"

china, black, matt, surface glazed, underside biscuit

item	l x w x h in cm	PU
4505.01	27x20x2.8	3 pcs



plate "Velo"

white china, surface glazed, underside biscuit

item	l x w x h in cm	PU
4505	27x20x2.8	3 pcs





DESIGN
by
ZIEHER

“DressCoat” was created by the glass and porcelain designer Nadine Podewski. The elegant language of design is reminiscent of set tables, the creation of the plates and bowls respectively is characterised by the apparently free falling drapery of table cloth. This creates a seemingly weightless, almost floating effect.

The slightly concave shaped surface offers space for artful decorated dishes and reliably avoids the sloshing of sauce.

“DressCoat” is available in five different sizes. Besides the main application as a plateau plate each item can also be used as a bowl. The falling folds add up to an exciting game of shapes - in particular if used as a bowl.

With “DressCoat” you will dish up delicacies!



Food: www.sander-gourmet.com

"DressCoat"



One of the smallest "DressCoat" variations (item 4386.02B) is unglazed on the outside. It is characterised by its fine body and pleasant haptics. The filigree porcelain item is translucent and is therefore - besides being a stunning means to present food - also perfectly suitable as a tea light holder!



plateau plate "DressCoat"

white china, useable area (plateau, glazed): Ø 6.5 cm, also useable as a bowl: 0.09 l content, Ø 8 cm, 4 cm high

item	outside	PU
4386.02B	unglazed	12 pcs
4386.02	glazed	12 pcs



plateau plate "DressCoat"

white china, useable area (plateau): Ø 7.5 cm, also useable as a bowl

item	Ø / height in cm	content in l	PU
4386.01	9 / 4.5	0.1	12 pcs

"DressCoat" - unglazed!





plateau plate "DressCoat"

white china, useable area (plateau): Ø 10.5 cm,
also useable as a bowl

item	Ø / height in cm	content in l	PU
4386	13 / 6.5	0.4	6 pcs

plateau plate "DressCoat"

in black gift box

Art.-Nr.	Ø / height in cm	content in l	PU
4386.PB	13 / 6.5	0.4	1 pc. 



plateau plate "DressCoat"

white china, useable area (plateau): Ø 15 cm,
also useable as a bowl

item	Ø / height in cm	content in l	PU
4387	17 / 8.5	0.85	3 pcs

plateau plate "DressCoat"

in black gift box

item	Ø / height in cm	content in l	PU
4387.PB	17 / 8.5	0.85	1 pc. 



plateau plate "DressCoat"

white china, useable area (plateau): Ø 19.5 cm,
also useable as a bowl

item	Ø / height in cm	content in l	PU
4388	22 / 6.5	0.9	3 pcs

plateau plate "DressCoat"

in black gift box

item	Ø / height in cm	content in l	PU
4388.PB	22 / 6.5	0.9	1 pc. 





plate "Pueblo"

stoneware, outside white (matt-finish), inner part white (glossy), round, organically shaped rim

item	Ø in cm	height in cm	PU
4605.18	18	approx. 1.5	6 pcs
4605.23	23	approx. 1.8	6 pcs
4605.27	27	approx. 2.2	6 pcs



miniature "Pueblo"

stoneware, outside white (matt finish), inside white (glossy), round, organically shaped

item	Ø / height in cm	content in l	PU
4604.01	6.5 / 5.2	0.09	6 pcs
4604.02	6.5 / 7.2	0.15	6 pcs



bowl "Pueblo"

stoneware, outside white (matt finish), round, organically shaped, Ø 12 cm, 4.5 cm high, 0.3 l content

item	colour inside	PU
4602.12	glossy white	4 pcs
4603.12	glossy taupe	4 pcs



bowl "Pueblo"

stoneware, outside white (matt finish), inside taupe (glossy), round, organically shaped

item	Ø in cm	height in cm	content in l
4601.22	22.5	7	approx. 1.8
4601.27	27.5	8.5	approx. 3.2
4601.33	33.5	10.5	approx. 6.5

The double-walled stainless steel bowls "Shine" are available on page 72.



bowl "Pueblo"

stoneware, outside white (matt finish), inside taupe (glossy), oblong, organically shaped

item	l x w x h in cm	PU
4600.28	28.5x12.5x7	2 pcs
4600.35	35x15.5x8.5	1 pc.
4600.40	40x18x9.5	1 pc.
4600.45	45x20x11.5	1 pc.



The glass series VISION is available on pages 203 to 209.

The stoneware series "Pueblo", due to its appearance, is reminiscent of unique handmade pieces. The filigree body, organic shapes and the charming contrast between matt and shiny glaze awards the certain something to that series.

The matt outside of the plates and bowls generates a pleasantly soft haptic effect, shiny glazed insides are done in a slightly shaded white or stylish taupe colour, depending on the product. "Pueblo" can be used at a set table but also in the buffet area and adds a natural and unobtrusive quality to the dishes.

"Dots"



plate "Dots"

white china, surface glazed, nubby on one half for the safe placement of miniatures, underside biscuit

item	l x w x h in cm	PU
4506	30x18.5x2.2	3 pcs



small bowl

white china, rectangular

item	l x w x h in cm	content in l	PU
3858	13.5x6.5x2	0.07	12 pcs



small bowl

white china, square

item	l x w x h in cm	content in l	PU
3859	6.5x6.5x2	0.03	12 pcs



small bowl

glass, transparent, square, delivery without lid item 5254.01 (please order separately)

item	l x w x h in cm	content in l	PU
5254	4.9x4.9x4.5	0.05	4 pcs



small creamer

glass, transparent, square, delivery without lid item 5254.01 (please order separately)

item	l x w x h in cm	content in l	PU
5255	4.9x4.9x4.5	0.05	4 pcs



glass miniature

transparent, lid for mini bowl items 5254 and 5255

item	l x w in cm	PU
5254.01	4.9x4.9	12 pcs

Aside from being decorative elements, the nubs on the surface of the "Dots" plate are a simple and functional means to place safely miniatures made of glass and porcelain.

The separation of liquid and solid, hot and cold food can be realized in an easy and visually appealing way.

No matter if it is used for sushi, desserts or Fine Dining, "Dots" is ideal for lots of applications!



glass box

transparent, square, delivery without lid item 5338.01 (please order separately)

item	l x w x h in cm	content in l	PU
5338	7x7x3.9	0.1	12 pcs



small bowl

glass, transparent, square

item	l x w x h in cm	content in l	PU
5258	7x7x4.5	0.13	12 pcs

glass miniature

transparent, lid for glass box item 5338

item	l x w in cm	PU
5338.01	7x7	12 pcs



DESIGN
by
ZIEHER

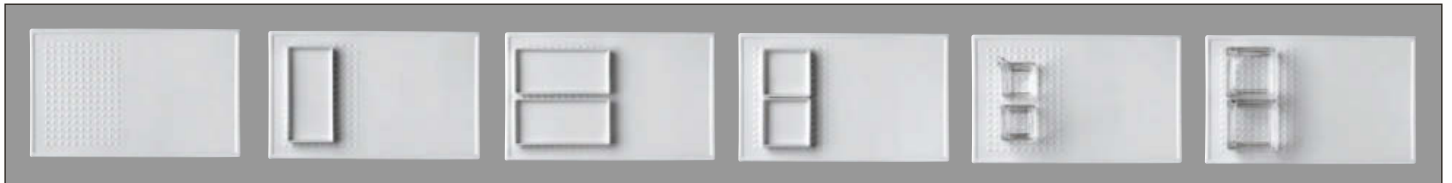

Design: Wilma Greim

"Collina"



small bowl/cloche

glass, transparent, handblown, for platter "Collina" item 4503

item	Ø / height in cm	content in l	PU
5418	9 / 6	0.2	6 pcs



glass

for platter "Collina" item 4504

item	Ø / height in cm	content in l	PU
5380	7.5 / 10.5	0.32	6 pcs
5381	7.5 / 6	0.18	6 pcs



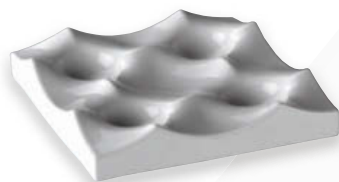

platter "Collina"

white china, with 4 deepenings, not dishwasher-safe, with 4 rubber feet (enclosed in the pack)

item	l x w x h in cm
4503	24.5x24.5x4.5

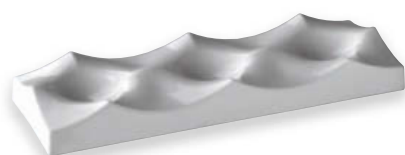

platter "Collina"

white china, with 3 deepenings, not dishwasher-safe, with 4 rubber feet (enclosed in the pack)

item	l x w x h in cm
4504	36.5x12.5x4.5

platter "Collina"

in black gift box

item	l x w x h in cm
4504.PB	36.5x12.5x4.5

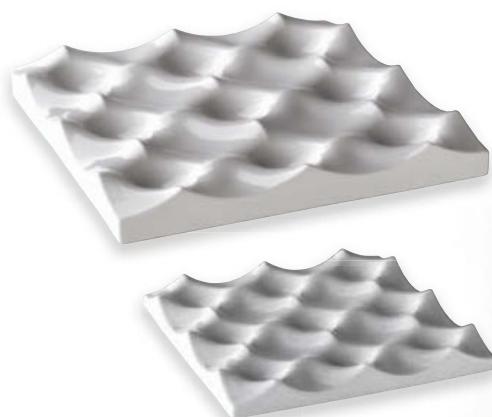

platter "Collina"

white china, with 9 deepenings, not dishwasher-safe, with 4 rubber feet (enclosed in the pack)

item	l x w x h in cm
4501	36.5x36.5x4.5
4502	26x26x3.2

platter "Collina"

in black gift box

item	l x w x h in cm
4501.PB	36.5x36.5x4.5



"Collina" provides almost unlimited possibilities. Whether in the lobby or on the buffet, for the presentation of fruit and pastry or as an exclusively decorative element, this series is versatile. The smaller version of the plate, which is divided into nine parts, is perfectly suitable for various antipasti and delicacies from the patisserie. A selection of fruit can be put in the limelight beautifully by using platters with either three or four deepenings.

The possibilities when considering private use are numerous, too. "Collina" may be used as a fruit bowl, but it is also suitable as a means to neatly organize objects of everyday life, such as the mobile phone or keys.

In order to protect the sensitive surfaces of furniture, every plate comes with feet made of rubber, which can be stuck on if needed. The rigorously geometrical structure permits the assembling of several plates which allows to enlarge the platter in both - length and width. When looking at the surface from the side, the arrangement has the appearance of a desert landscape arbitrarily formed by the wind.





"Plat de Luxe"



plate "Plat de Luxe"
white china, deep

item	Ø in cm	PU
4521.26	26	6 pcs



plate "Plat de Luxe"
white china, flat

item	Ø in cm	PU
4520.28	28	6 pcs
4520.32	31.6	6 pcs



plate "Plat de Luxe"
white china, flat, with decor "geo" (white)

item	Ø in cm	PU
4520.32D1	31.6	6 pcs



plate "Plat de Luxe"
white china, flat, with decor "free" (black)

item	Ø in cm	PU
4520.32D2	31.6	6 pcs





The small series "Plat de Luxe" offers the perfect basis for the presentation of high-quality foodstuffs. Two flat plates and one deep plate convince by their fine porcelain body and the reduced design, which has been taken from a sphere in all parts. In addition to the plain white version, the biggest plate is also available with two decors. The black decor "free" has a modern and playful aspect, the white decor "geo" is the classic, reserved variant. Whatever the use, "Plat de Luxe" convinces everywhere – in the gourmet restaurant as well as in conventional catering.



"oro79"



plate "oro79"

china, golden surface, with foot, dishwasher-safe, not suitable for microwave and combi steam oven

item	l x w x h in cm	PU
4564.12	12x12x1.5	2 pcs
4564.19	19x19x1.5	2 pcs
4564.26	26.5x26.5x1.5	1 pc.

"oro79" is pure luxury!

This exclusive miniseries captivates by its extraordinary surface with its golden mother-of-pearl look. A quartered ball allows serving a variety of food in an entirely new way.

"oro79" offers exceptional service for the most demanding guests!

Non-slip coasters are available on page 210, the glass series "Amuse" is available on pages 216 to 220.



plate "oro79"

china, golden surface, with foot, dishwasher-safe, not suitable for microwave and combi steam oven

item	l x w x h in cm
4565.35	35x14x1.5



china ball "oro79"

china, outside golden, quartered (3 bowls: 0.5 l / 0.6 l / 0.25 l content + lid), dishwasher-proof, not suitable for microwave and combi steam oven

item	Ø in cm	height in cm
4563	15.5	15.8





"Catering"

- High-quality white china
- In accordance with international standards
- Cups with glazed rims
- Stackable
- Dishwasher-safe



flat plate

item	Ø in cm	PU
3955.16	16	12 pcs
3955.20	20	12 pcs
3955.26	26	12 pcs
3955.27	27	12 pcs
3955.30	29.5	6 pcs



china saucer

black, round, matt, with round deepening (Ø 9.3 cm)

item	Ø in cm	height in cm	PU
3857	13.5	1.5	6 pcs



dinner plate

item	Ø in cm	PU
3972.32	32	6 pcs



deep plate

item	Ø in cm	PU
3956.23	23	12 pcs
3971.30	30	6 pcs



oval coup platter

item	l x w x h in cm	PU
3939.25	25x15x3	6 pcs
3939.30	30x17.5x3.5	6 pcs
3939.35	35x20.5x4	6 pcs



flat coup plate

item	Ø in cm	PU
3954.08	8	12 pcs
3954.19	19	12 pcs
3954.21	21	12 pcs
3954.25	25	12 pcs
3954.23	23	12 pcs
3954.28	27.5	12 pcs



salad bowl

item	Ø in cm	height in cm	PU
3963.14	14	4.5	12 pcs
3963.16	16	4.5	12 pcs
3963.19	19	6	12 pcs
3963.23	23	6.5	6 pcs



coffee cup

cup content: 0.18 l, Ø saucer: 15 cm

item	version	PU
3958.O	cup	12 pcs
3958.U	saucer	12 pcs



soup cup

cup content: 0.4 l, Ø saucer: 17 cm

item	version	PU
3960.O	cup	12 pcs
3960.U	saucer	12 pcs



tapas bowl

item	Ø / height in cm	content in l	PU
3962.06	6 / 3	0.03	24 pcs



egg cup

item	Ø in cm	height in cm
3977	5	5



creamer

item	Ø / height in cm	content in l	PU
4489	5.3 / 9	0.13	6 pcs



miniature

Ø 5.3 cm, 7 cm high 0.1 l content

item	colour	PU
4490	white	6 pcs
4490.01	black	6 pcs



small bowl

item	Ø / height in cm	content in l	PU
4499	8 / 5.5	0.2	6 pcs
4500	8 / 2.5	0.08	12 pcs





plate "Catering de Luxe"

white china, deep

item	Ø in cm	PU
4280.22	22	6 pcs
4280.30	30	3 pcs



bowl "Catering de Luxe"

white china, bowl item 4281 to insert in deep plate "Catering de Luxe" item 4280.22 and bowl item 4281.02 to insert in deep plate "Catering de Luxe" item 4280.30

item	Ø / height in cm	content in l	PU
4281.01	12 / 5/6.5	0.25	12 pcs
4281	14 / 5.5/7.5	0.35	6 pcs
4281.02	19 / 7.5/10	1.0	6 pcs
4281.03	24 / 9.5/12.5	2.0	2 pcs
4281.04	28 / 11/14.5	3.5	2 pcs



fondue, two-part

white china, for tea lights, upper part: Ø 6.3 cm, 7 cm high, 0.14 l content, lower part: Ø 6.3 cm, 7 cm high

item	total height in cm	PU
4359	13.5	6 pcs



fondue insert

borosilicate glass, transparent, handblown, double-walled, for fondue item 4359 and silicone ring "SelectionA." items 4681...

item	Ø / height in cm	content in l	PU
4958	11 / 5.5	approx. 0.1	6 pcs



small skewer

stainless steel 18/0, matt, 9.5 cm long

item	version	PU
1939.03	moon	24 pcs
1939.04	flame	24 pcs

"Catering de Luxe"



DESIGN
by
ZIEHER





miniature bowl "Spobo" with spoon rest

white china, for spoons with a total length of 12 cm and over

item	Ø / height in cm	content in l	PU
4230.11	10.5 / 3.9	0.07	12 pcs

spoon recommendation

for mini bowl "Spobo" item 4230.11

item	version	PU
0492.07	tea spoon "Goa"	12 pcs
0493.07	tea spoon "Mao"	12 pcs



fruit/dessert bowl "Spobo" with spoon rest

white china, for spoons with a total length of 15 cm and over

item	Ø / height in cm	content in l	PU
4230.14	14 / 5	0.18	6 pcs

fruit/dessert bowl "Spobo" with spoon rest in black gift box

item	Ø / height in cm	content in l	PU
4230.14PB	14 / 5	0.18	1 pc. 

spoon recommendation

for fruit/dessert bowl "Spobo" item 4230.14 and 4230.14PB

item	version	PU
0492.04	dessert spoon "Goa"	12 pcs
0493.04	dessert spoon "Mao"	12 pcs



soup bowl "Spobo" with spoon rest

white china, for spoons with a total length of 20 cm and over

item	Ø / height in cm	content in l	PU
4230.18	18.5 / 6.5	0.42	3 pcs

soup bowl "Spobo" with spoon rest in black gift box

item	Ø / height in cm	content in l	PU
4230.18PB	18.5 / 6.5	0.42	1 pc. 

spoon recommendation

for soup bowl "Spobo" item 4230.18 and 4230.18PB

item	version	PU
0492.01	table spoon "Goa"	12 pcs
0493.01	table spoon "Mao"	12 pcs
1938	party spoon, polished	1 pc.
1938.01	party spoon, hammered finish	1 pc.

GOA MAO



The complete cutlery series "Mao" and "Goa" are available on pages 297 to 300.

"Spobo"

Whether it is a nutritious breakfast, cereals or an amazing gazpacho – "Spobo" offers a variety of possibilities. Allowing a spoon or fork to be rested on the rim of the bowl, "Spobo" stands for effortless and uncomplicated handling, even in daily use and surprises by its innovative look.

Innovative porcelain ...



... for a creative gastronomy!



miniature bowl "Spobo" with spoon rest
glass, transparent, for spoons with a total length of 12 cm and over

item	Ø / height in cm	content in l	PU
5440	10 / 4	0.08	6 pcs

spoon recommendation
for mini bowl "Spobo" item 5440

item	version	PU
0492.07	tea spoon "Goa"	12 pcs



The black glass trays are available on page 276.

"Duo"



The delicate handle of the "Duo" duet's organically-shaped bowl literally penetrates the saucer. Both parts thus melt into a unity of form and function. Taken individually, the saucer creates a perfect space for the presentation of amuse gueule, tapas or antipasti variations. The small opening in the handle leaves space for decorative accents.

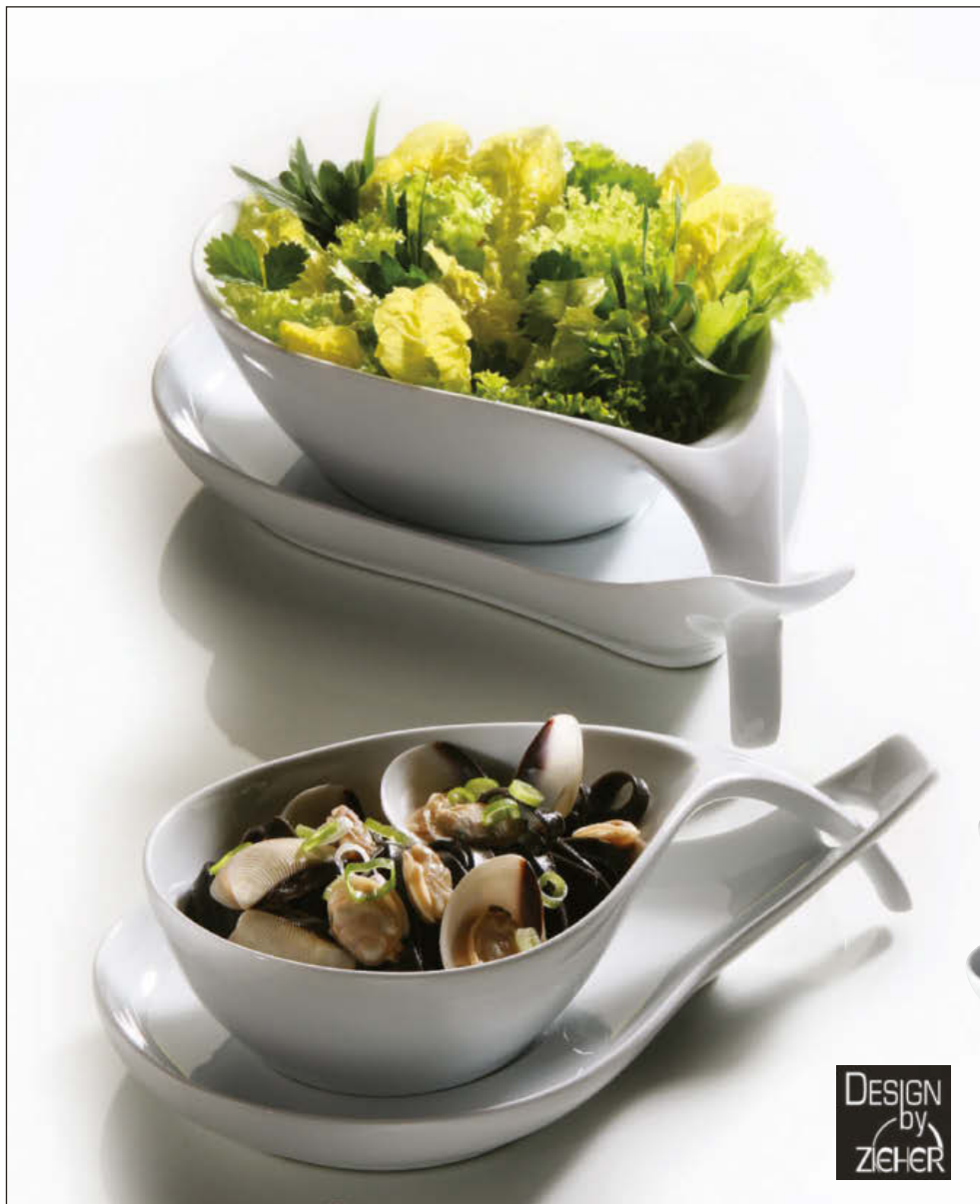

The tray "Podia" item 8732.01 is available on page 27.



bowl "Duo"

glass, transparent

item	l x w x h in cm	content in l	PU
5441	11.5x7x3.5	0.07	6 pcs



bowl "Duo"

white china

item	l x w x h in cm	content in l	PU
4231.SO	13x7x3.5	0.08	12 pcs



glass tray with bowls

set consists of:

glass tray, deep black

3 china bowls "Duo", white, 0.08 l content each
1 set in black gift box

item	l x w in cm	PU
5135.PB	32x12	1 set (4 parts)



bowl + small platter "Duo"

white china, 0.28 l content (bowl)

item	version	l x w x h in cm	PU
4231.MO	bowl	22x11.7x5	6 pcs
4231.MU	small platter	23.5x14x5	6 pcs



bowl + platter "Duo"

white china, 0.63 l content (bowl)

item	version	l x w x h in cm	PU
4231.LO	bowl	27.5x15x6.5	3 pcs
4231.LU	platter	30x18x5.5	3 pcs

SELECTION **A.**



SelectionA. gives creative chefs the opportunity to present their food in many different ways in order to leave a mark with their guests both by taste and looks. The dish moves closer to the guest and single parts almost seem to be floating freely in the room. The diversity of variations of this series, when combined with other items, is nearly unlimited.



The series consists of different plates and bowls made of porcelain and glass. So-called "dinner plates" are available in two versions which can be used on their own or in combination with various attachments. These form the basis of the system. Shapely rings made of silicone available in two sizes, in black or white, allow for a piling of different accessories and are completely slip-proof. Surfaces are matt structured and form an interesting contrast to the porcelain's shiny gloss. These pieces can be consciously used as design elements or, as well, be assembled almost invisibly. There are no limits to the chef's imagination.

A third ring outside the series (page 224) has been designed to hold test-tubes, the ribbed surface structure ensuring easy insertion of the tubes.



1 dinner plate "SelectionA."
white china, with plateau (Ø 9.5 cm)

item	Ø in cm	PU
4491	28	3 pcs



2+6+4



2 dinner plate "SelectionA."
white china, with hollow (Ø 11 cm, 0.15 l content)

item	Ø in cm	PU
4492	28	3 pcs



3 plate "SelectionA."
white china, with hollow
(4493.19: Ø 6.2 cm, 0.05 l content,
4493.24: Ø 9 cm, 0.14 l content)

item	Ø in cm	PU
a)4493.19	19	6 pcs
b)4493.24	24	6 pcs



4 plate "SelectionA."
white china, oval

item	l x w in cm	PU
4495	25x12	6 pcs



3b+6b+5



5 small bowl "SelectionA."
borosilicate glass, transparent, handblown,
double-walled

item	Ø / height in cm	content in l	PU
4957	9.7 / 3.5	approx. 0.07	6 pcs

2+6+3a

SELECTION A.



6 ring "SelectionA."
silicone, for inlaying/stacking of the china series "SelectionA.", Ø 8.3 cm

item	colour	PU
a)4681.S	black	6 pcs
b)4681.W	white	6 pcs



7 ring "SelectionA."
silicone, for inlaying/stacking of the china series "SelectionA.", Ø 13.4 cm

item	colour	PU
a)4682.S	black	3 pcs
b)4682.W	white	3 pcs



8 small bowl/cloche
glass, transparent, handblown, for ring "SelectionA." items 4681... (please order separately)

item	Ø / height in cm	content in l	PU
5418	9 / 6	0.2	6 pcs



9 fondue insert
borosilicate glass, transparent, handblown, double-walled, for fondue item 4359 and silicone ring "SelectionA." items 4681...

item	Ø / height in cm	content in l	PU
4958	11 / 5.5	approx. 0.1	6 pcs



10 small bowl
glass, 2 layers, handmade, heavy quality, Ø 7 cm, 4.5 cm high, approx. 0.08 l content, for sushi platter item 8035

item	version	PU
4859.07	white	6 pcs
4860.07	black	6 pcs



11 bowl
massive stainless steel 18/10, triangular, hammered finish, six times polished

item	Ø in cm	height in cm	content in l
a)2180.09	9	4	0.08
b)2180.13	13	6	0.28

A smooth version of both bowls is available on page 85.

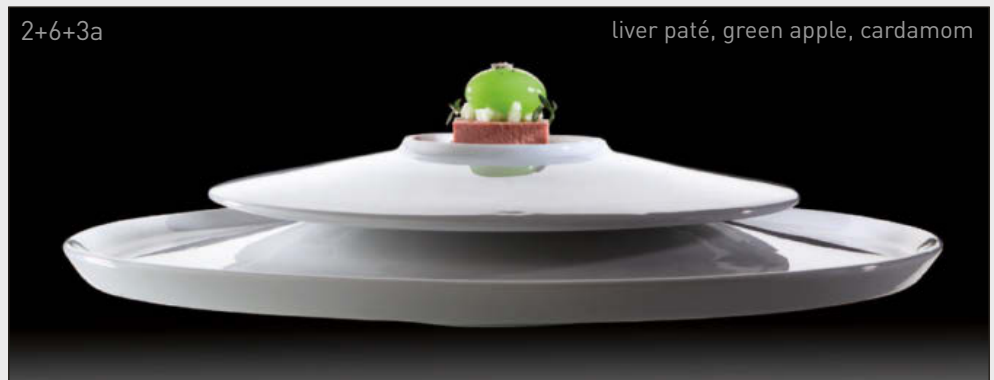



2+6a+9



2+6a+11b



3b+5+6a



2+3a+6b



3b+6a+11a



2+6a+10b



3b+6a+9



4+5+6a

SELECTION A.





The series "Modul" is available on pages 172 and 173.



glass tube "Sauce Flow"

borosilicate glass, open at the top and at the bottom

item	Ø / height in cm	content in l	PU
4990.01	3 / 5.5	0.02	6 pcs
4990.02	5 / 5.5	0.1	6 pcs



glass tube "Soup Flow"

borosilicate glass, open at the top and at the bottom

item	Ø / height in cm	content in l	PU
4989	6.5 / 11	0.4	6 pcs

The glass tube "Flow" item 4990.02 can also be used as a napkin ring.



The "Flow" series permits a variety of new creative potential to the chef, a possibility to present different elements in a new and perfect way. Since it comes in three sizes, the tubes can be applied in any part of the kitchen: The small "Sauce Flow" is especially suited for presenting sauces during the main course or entrée. The "Soup Flow" is extraordinarily interesting when serving soup in transparent glass either standing or flowing with some puree acting as sealing. It is possible to present liquids in layers which can be released either by service staff or the guests themselves. That way liquid food can be set up in a very stylish way, separated from any crispy food. With salad designed as biosphere or a vegetable skyscraper - there is no limit to your imagination except the edge of the plate.

The glass tubes "Flow" are available in three sizes and made of high-quality borosilicate glass which stands out due to its hardness and high temperature resistance.

items 4989 + 4492 (page 168)



"Modul" - Play upon a variety of possibilities



glass plate "Modul"
transparent, flat, lengthwise, for base trays "Modul" made of walnut and melamine

item	l x w in cm	PU
5074.01	22.5x11	6 pcs



bowl "Modul"
white china, square, deep, for base trays "Modul" made of walnut and melamine

item	l x w in cm	content in l	PU
4381	11x11	0.07	12 pcs



plate "Modul"
white china, square, flat, for base trays "Modul" made of walnut and melamine

item	l x w in cm	PU
4380	11x11	12 pcs



glass plate "Modul"
frosted look, flat, lengthwise, for base trays "Modul" made of walnut and melamine

item	l x w in cm	PU
5074.02	22.5x11	6 pcs



bowl "Modul"
white china, deep, lengthwise, for base trays "Modul" made of walnut and melamine

item	l x w in cm	content in l	PU
4384	22x11	0.22	12 pcs



plate "Modul"
white china, flat, lengthwise, for base trays "Modul" made of walnut and melamine

item	l x w in cm	PU
4383	22x11	12 pcs



glass plate "Modul"
deep black, flat, lengthwise, for base trays "Modul" made of walnut and melamine

item	l x w in cm	PU
5074.03	22.5x11	6 pcs

More party spoons made of china and stainless steel are available on page 240.



amuse-gueule/tapas spoon "Modul"
white china

item	l x w x h in cm	PU
4260.03	10x4x2.2	12 pcs



"Cave"

Like the shell hides the pearl, the porcelain bowl "Cave" conceals precious delicacies within its hard shell. At first sight this porcelain piece only partly reveals its interior. "Cave" consists of intricately worked hard porcelain and captures by its soft shape and the velvety haptics of the unglazed outside. Touching the cave-shaped bowl it feels almost like a palm stone made of white gold, having a soft appearance with delicious contents. "Cave" is predestined for a use at cocktail and hors d'oeuvres receptions or at the flying buffet. The miniature bowl can be carried comfortably and perfectly fits in the palm of the hand.



New!



bowl "Cave"

biscuit china, white, inside glazed, opening:
Ø approx. 8 cm, in black gift box

item	Ø in cm	height in cm	PU
4375.01PB	approx. 11	7	1 pc.



Design: Wilma Greim



plate "Modul"

white china, flat, item 4385.22 fits base trays
"Modul" made of walnut and melamine

item	l x w in cm	PU
4385.22	22x22	6 pcs
4385.27	27x27	4 pcs

"Modul"



The bridge "Modul" made of walnut and suitable inserts are available on pages 132 and 139.

"Capiz"



bowl "Capiz"

shell, ivory-coloured, resin-coated, oval, not dishwasher-safe

item	l x w x h in cm
7106.46	46.5x24x13.5

Buffet bowls of the series "Capiz" are available on page 71.



tray "Capiz"

shell, ivory-coloured, resin-coated, square, not dishwasher-safe

item	l x w x h in cm
7103.20	20x20x2
7103.26	26x26x2

The glass plates are available on page 176.

In combination with ice and the Zieher rechargeable LED-lights the double-walled bowls produced in mosaic-look create fascinating effects, thus becoming the eye-catcher at the buffet.



dinner plate "Capiz"

shell, taupe-coloured, resin-coated, not dishwasher-safe

item	Ø in cm	PU
7116.36	36	2 pcs



bread plate "Capiz"

shell, ivory-coloured, resin-coated, organically shaped, not dishwasher-safe

item	Ø in cm	PU
7100.16	16	4 pcs



dinner plate "Capiz"

shell, ivory-coloured, resin-coated, organically shaped, not dishwasher-safe

item	Ø in cm	PU
7100.31	31	2 pcs
7100.36	36	2 pcs



dinner plate "Capiz"

shell, ivory-coloured, resin-coated, not dishwasher-safe

item	Ø in cm	PU
7115.36	36	2 pcs



The glass NOSTALGIC of the series VISION is available on page 207.

Ivory-coloured, nacreous gloss grants these products their special appeal. Genuine clamshells are grinded razor-thin and embedded in robust resin. This process protects and stabilizes the delicate clamshell-wafers in the long term. The transparent resin creates an impressive depth effect and classy shine on every item of the "Capiz" series. This especially applies to the structured surfaces and shoulders of the dinner plates. These plates with their radially structured shoulders are available in the light version as well as in the trend colour taupe.



Please note the care instructions: suitable for cold and dry food, not dishwasher-safe.

The filigree but extremely strong plates made of imbued glass inspire by their exceptional look and the reduced design. Wide rims put skilfully arranged dishes into the focus of events, the irregular surface of the deep and flat plates is reminiscent of elaborate handicraft and bestows an extravagant character on the series.



miniature glass bottle

glass, round, with glass lid (round), with notched stopper for pouring with closed lid, height incl. lid

item	Ø in cm	height in cm	content in l
5741	4.3	5.5	approx. 0.03

Non-slip coasters made of silicone are available on page 210, the glass cloche item 4982.09 on page 191.



glass plate

black, flat, hammered optic, dishwasher-safe

item	Ø in cm	PU
5730.18	18	3 pcs
5730.23	23	3 pcs
5730.26	26.5	3 pcs



The dinner plate made of laminated plastic is available on page 199.

The cutlery/napkin box "Solid" is available on page 248.



glass plate

black, deep, hammered optic, dishwasher-safe

item	Ø in cm	PU
5731.19	19	3 pcs
5731.23	23.5	3 pcs
5731.28	28	1 pc.

"Ice"

The absolutely stunning plates of the "Ice" series are made of glass chips which are coalesced and compressed. This procedure allows white and transparent materials to form a most charming pattern. The horizontal look of ice floes paired with the layered structure at the edges brings to mind an ice plate freshly cut from a frozen, wintery lake.



dinner plate "Ice"

glass (crimped glass chips), white, round, bevelled edges, dishwasher-safe

item	Ø in cm	height in cm
5760.35	35	2



dinner plate "Ice"

glass (crimped glass chips), white, square, bevelled edges, dishwasher-safe

item	l x w x h in cm
5761.33	33x33x2



glass platter "Ice"

glass (crimped glass chips), white, rectangular, bevelled edges, dishwasher-safe

item	l x w x h in cm
5762.16	16x12x2
5762.33	33x12x2
5762.40	40x15x2



Bevelled edges provide an elegant look as well as easy handling. No matter if it is used as a dinner plate or as a sushi plate, for the presentation of a variety of cheese or the staging of desserts, muted colours combined with a clear structure create a perfect basis for stylishly putting artful creations in the limelight.

The cloche item 4880.30 is available on page 189.



Please note:

due to the material properties, minor imperfections and air inclusions may occur around the edges.



glass tray

deep black, rectangular, for buffet or flying buffet, also functions as a tray

item | l x w x h in cm

5141.26 | 26x14x2

5141.34 | 34x18x2

5141.50 | 51x35x2



glass tray

deep black, square, for buffet or flying buffet, functions as a tray or as a dinner plate

item | l x w x h in cm

5142.34 | 35x35x2



glass platter

deep black, with deepening (Ø 8 cm)

item | l x w x h in cm | PU

5154 | 29.5x20x3 | 3 pcs



glass tray

deep black, with 3 oval sockets (diagonal, 4.7 cm x 8.5 cm at bottom area), for small bowl items 4081.12 (china) and 5444 (glass)

item | l x w in cm

5143 | 32x15



glass tray

deep black, with 3 round sockets (Ø 6 cm at bottom area)

item | l x w in cm

5145 | 32x12



glass tray with bowls

set consists of:

glass tray, deep black

3 china bowls "Duo", white, 0.08 l content each

1 set in black gift box

item | l x w in cm | PU

5135.PB | 32x12

1 set (4 parts)





2 layers of glass
in high quality

bowl

glass, 2 layers, white, handmade, heavy quality

item	Ø / height in cm	content in l	PU
4857.10	10 / 5.5	approx. 0.25	6 pcs
4857.14	14 / 7.5	approx. 0.7	6 pcs
4857.16	16 / 8.5	approx. 1.2	4 pcs



2 layers of glass
in high quality

bowl

glass, 2 layers, black, handmade, heavy quality

item	Ø / height in cm	content in l	PU
4858.10	10 / 5.5	approx. 0.25	6 pcs
4858.14	14 / 7.5	approx. 0.7	6 pcs
4858.16	16 / 8.5	approx. 1.2	4 pcs



small bowl

glass, 2 layers, handmade, heavy quality, Ø 7 cm,
4.5 cm high, approx. 0.08 l content, for sushi platter
item 8035

item	version	PU
4859.07	white	6 pcs
4860.07	black	6 pcs

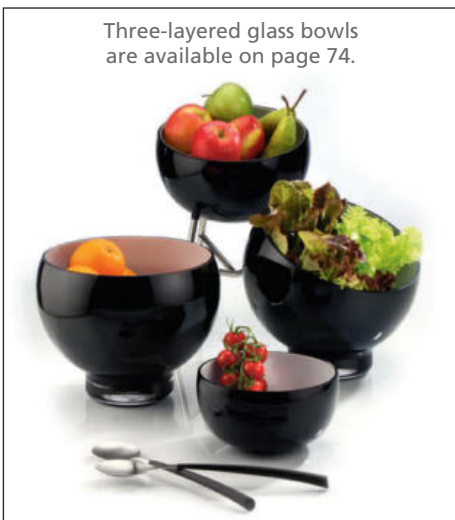

Three-layered glass bowls
are available on page 74.

Two layers of glass -



fused in one!



The sushi platter is
available on page 180.



The cutlery "Goa" is available on page 300.



glass platter

deep black, with deepening (Ø 8 cm)

item	l x w x h in cm	PU
5154	29.5x20x3	3 pcs

More platters made of special hardened safety glass are available on pages 58 and 59.



glass platter

special hardened safety glass, rectangular, rounded edges, polished rim, dishwasher-safe, rubber feet included (adhesive), underside scratch-proof, 4 mm thick

item	version	l x w in cm
1668.10	black glass	30x18
1670.10	white glass	30x18



sushi tray

granite, anthracite, completely polished, with hole (Ø 5.7 cm) for different inserts of glass, china,...

item	l x w x h in cm
8035	40x15x2.5

The double-walled glass bowls are available on page 223.



small bowl

glass, 2 layers, handmade, heavy quality, Ø 7 cm, 4.5 cm high, approx. 0.08 l content, for sushi platter item 8035

item	version	PU
4859.07	white	6 pcs
4860.07	black	6 pcs

"Sushi and more!"



The glass platters of the series "Ice" are available on page 177.



The black grey glass platter is available on page 182.



The plate "Dots" is available on page 154.



sushi tray

granite, anthracite, completely polished, feet of felt

item	l x w x h in cm
8028	25x25x3



sushi set

set consists of:

glass platter, dark grey with spiral structure

china bowl "Cuspis" incl. black silicone coaster

chop sticks "Goa" incl. bench

1 set in black gift box

item	l x w in cm	PU
5170.PB	approx. 38x15.5	1 set (6 parts)



The series "Cuspis" is available on page 213, more sizes of the platters with spiral structure on page 183.

The buffet bowl made of grey glass is available on page 77.



The glass miniature is available on page 225, the cutlery "Goa" on page 300.



glass plate

dark grey, rectangular, with the structure of tree bark

item	l x w in cm	thickness in mm	PU
5702	40x22	8	2 pcs



glass plate

dark grey, oval, with the structure of tree bark

item	l x w in cm	thickness in mm	PU
5700	33x24	8	3 pcs



glass bowl

dark grey, oval, with the structure of tree bark

item	l x w x h in cm	thickness in mm	PU
5701	26.5x19.5x4.5	8	3 pcs



glass plate "Ribbon"

dark grey, round, flat

item	Ø in cm	PU
5149.32	32.5	3 pcs



glass bowl

dark grey, square, structured

item	l x w x h in cm	PU
5016.24	24x24x5	2 pcs



glass plate/dish

dark grey, with plateau and deep rim

item	Ø outside in cm	Ø inside in cm
5137.34	34.5	14.5



items 5137.34 + 4956.04 (page 223)





New!

spoon rest/glass miniature

dark grey, with spiral structure, 4 mm thick

item	l x w in cm	PU
5168.06	approx. 6.5x5	12 pcs

New!

glass platter/plate

dark grey, squarish, with spiral structure, 6 mm thick

item	l x w in cm	PU
5168.14	approx. 14x10.5	6 pcs
5168.25	approx. 25x20.5	6 pcs
5168.30	approx. 30.5x25	4 pcs

New!

glass platter/plate

dark grey, longish, with spiral structure, 6 mm thick

item	l x w in cm	PU
5169.31	approx. 31x12.5	6 pcs
5169.38	approx. 38x15.5	4 pcs
5169.41	approx. 41.5x12.5	4 pcs

New!

sushi set

set consists of:

glass platter, dark grey with spiral structure

china bowl "Cuspis" incl. black silicone coaster

chop sticks "Goa" incl. bench

1 set in black gift box

item	l x w in cm	PU
5170.PB	approx. 38x15.5	1 set (6 parts) 





The miniature bowls made of glass or china are available on page 261.

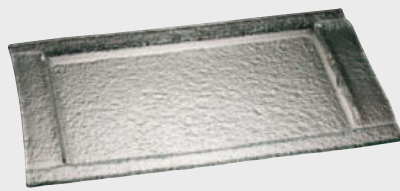

buffet tray

glass, transparent, rectangular, with handles

item	l x w in cm
5075.40	40x25



glass platter "Vario"

glass, frosted look, square, with 9 sockets

item	l x w in cm
5088	30x30



glass platter

glass, transparent, rectangular, four divisions

item	l x w in cm
5084	33x12



The miniature bowl item 4082 made of china is available on page 235.



glass tray

glass, transparent, rectangular

item	l x w in cm
5062	30x23



glass tray "Wave", 1/1 GN

glass, transparent, undulated edge

item	l x w in cm
5020	53x32.5



glass platter

glass, transparent, rectangular

item	l x w in cm
5064	33x12

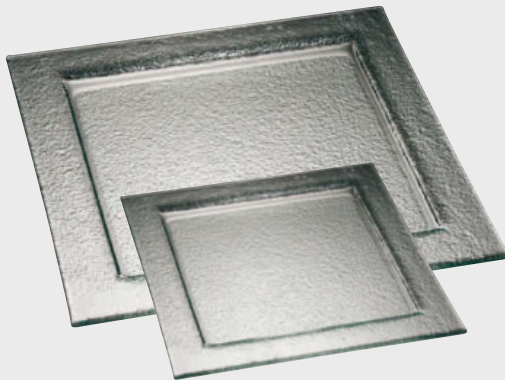

glass platter

glass, transparent, square

item	l x w in cm
5063	30x30
5063.50	50x50



glass bowl

glass, transparent, oval, with texture

item	l x w x h in cm	PU
5127.32	31.5x20.5x4	2 pcs



items 4451 + 4490.01 (page 162)

tray

china, black, matt, with rim

item	l x w x h in cm	PU
4451	22x11.5x2.3	6 pcs
4455	21x21x2.3	4 pcs

The glass trays are available on page 25.





glass bowl
transparent, oval

item	Ø / height in cm	content in l	PU
5330.08	7.5 / 3.5	0.08	6 pcs
5330.20	20 / 10	1.1	1 pc.
5330.24	24 / 12	2.3	1 pc.
5330.29	29 / 14.5	3.3	1 pc.

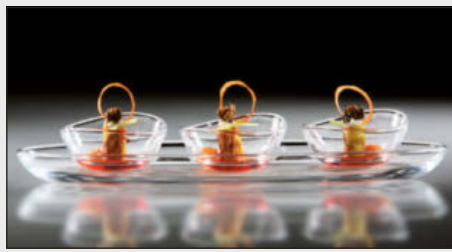

illustrated combination:
3x item 5330.08 on item 5331.30



glass platter
transparent, oval

item	l x w x h in cm	PU
5331.30	30x9.5x2	2 pcs



glass bowl
transparent, round

item	Ø / height in cm	content in l	PU
5329.14	14 / 8.5	0.6	6 pcs
5329.21	21.5 / 12.5	2.3	1 pc.
5329.25	25 / 15	3.5	1 pc.



small bowl
glass, transparent, handblown, for stand "TriBo"
items 2025... or for ring "SelectionA." items 4681...
(please order separately)

item	Ø / height in cm	content in l	PU
5419.01	approx. 11.5 / 6/9	approx. 0.2	6 pcs
5419.02	approx. 15 / 7.5/12	approx. 0.5	6 pcs

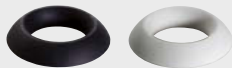

ring "SelectionA."
silicone, Ø 8.3 cm

item	colour	PU
4681.S	black	6 pcs
4681.W	white	6 pcs

The fruit/bread basket item 2168.15 is available on page 94.



caviar set
glass, transparent, square,
big bowl: 14x14x8.5 cm, 0.67 l content,
small bowl: 8x8x4.5 cm, 0.1 l content

item	l x w x h in cm	PU
5347	14x14x10	3 parts

The buffet stands "Skyline" are available on pages 6 to 12.



bowl
glass, transparent, square

item	l x w x h in cm
5346	35x35x8



The bread/pastry bowl is available on page 90.



glass bowl
transparent, square

item	l x w x h in cm	content in l	PU
5308.08	8x8x4.5	0.14	6 pcs
5308.11	11x11x6	0.3	6 pcs
5308	14x14x8	0.7	6 pcs
5308.20	20x20x11	1.8	1 pc.
5308.26	26x26x12.5	3.5	1 pc.

glass lid
transparent, for glass bowl item 5308.11

item	l x w in cm	PU
5308.11D	11x11	24 pcs

"Double-walled glass"

Handblown, double-walled glasses made of borosilicate glass combine spectacular optics and extraordinary technical features. The vacuum between the two glasses prevents the formation of condensate on the outside of the glass when the ambient temperature is warm and the drinks are cold. The isolation effect keeps cold and warm liquids cold or warm for a longer time.



decanter

borosilicate glass, transparent, handblown, double-walled

item	Ø in cm	height in cm	content in l
4952.05	8	25	approx. 0.5
4952.09	10	29	approx. 0.9



ice bucket

borosilicate glass, transparent, handblown, double-walled, without lid item 4950.D (please order separately)

item	Ø in cm	height in cm	content in l
4950	14	16	approx. 1.8
4950.D	glass lid for ice bucket		



tea set

borosilicate glass, transparent, handblown, double-walled, with glass lid and stainless steel tea strainer (removable)

item	Ø in cm	height in cm	content in l
4955	8	16.5	approx. 0.34



decanter

glass, transparent

item	Ø in cm	height in cm	content in l
5352	9	31	1.0

The wine cooler of the series "Skyline" is available on page 10.





Cloches

of some other kind!

"Cuspis"

The cloches and porcelain coasters of the series "Cuspis" are inspired by the nuts of the oak tree. The ball-shaped handle at the tip of the cloches allows for an uncomplicated handling of these classy covers. The unglazed outside of the porcelain coasters with its distinctive texture is reminiscent of acorn caps. The coaster can be used on both sides. When used as a plateau plate, the dishes move closer to the guest, while the filigree glass cloche protects the presented delicacies and puts them in the limelight. Used as a bowl, it offers space for gravies, sauces and more.



If the item is used upside down as a plate, the two rings on the plate's underside can be used to separate the prepared dish into different sections and the cloches of the "Cuspis" series may also be used with it (4940.10 on the inner ring, 4940.25 on the outer ring).



New!



glass cloche "Cuspis"

borosilicate glass, transparent, handblown, star-shaped ball handle

item	for plate/bowl	Ø in cm	height in cm
4940.08	4389.09	8.5	12.5
4940.10	4389.11	10.5	14.5
4940.25	4389.25PB	25	32.5

New!



plateau plate/small bowl "Cuspis"

white china, inside and useable area (plateau Ø approx. 6 cm/8 cm) glazed, outside biscuit, also useable as a bowl

item	Ø in cm	height in cm	content in l
4389.09	9	3	0.1
4389.11	11.5	3.5	0.18

GIFT BOX



New!

plateau plate/bowl "Cuspis"

white china, inside and useable area glazed, outside biscuit, useable on both sides, for cloches items 4940.25 and 4940.10 (bottom side), in black gift box

item	Ø in cm	height in cm	content in l
4389.25PB	25	2.8	0.8

GIFT BOX

New!



cloche with plateau plate "Cuspis"

set consists of:

cloche made of borosilicate glass, transparent, handblown, with star-shaped ball handle

plateau plate made of white china, inside and useable area glazed, outside biscuit, useable on both sides

1 set in black gift box

item	Ø in cm	height in cm	PU
4943.08PB	9	approx. 14/14.5	1 set (2 parts)
4943.10PB	11.5	approx. 17/17.5	1 set (2 parts)
4943.25PB	25	approx. 33/35	1 set (2 parts)



glass cloche

borosilicate glass, transparent, handblown, handmade, for saucer "Solid" items 4734...

item	Ø in cm	height in cm
4880.18	18.5	approx. 29-32
4880.22	22.5	approx. 35-38
4880.26	26	approx. 41-44
4880.30	30	approx. 48-51



glass insert "Solid"

hardened glass, transparent, with 4 transparent silicone feet, edge polished and deburred, 4 mm thick

item	Ø in cm	for saucer "Solid" item
5244.17	16.7	4734.01
5244.21	20.7	4734.02
5244.24	24.2	4734.03
5244.28	28.2	4734.04



saucer "Solid"

walnut, food-safe sealed, stackable, not dishwasher-safe, for glass cloche items 4850, 4851, 4852 and 4880... and glass inlay items 5244....

item	Ø / height in cm	for cloche / inlay
4734.01	23 / 3	Ø 18.5 / 16.7 cm
4734.02	27 / 3	Ø 22.5 / 20.7 cm
4734.03	30.5 / 3	Ø 26 / 24.2 cm
4734.04	34.5 / 3	Ø 30 / 28.2 cm



cloche with wooden saucer and glass insert

set consists of:

cloche made of borosilicate glass

insert made of hardened transparent glass (4 mm thick)

saucer made of walnut

1 set in black gift box

item	Ø in cm	height in cm	PU
4882.22PB	27	approx. 37-40	1 set (3 parts)
4882.30PB	34.5	approx. 50-53	1 set (3 parts)

The glass cloches, which are available in 10 sizes (diameters 5 cm to 30 cm, pages 189 to 193), delight by their high quality and unusual form!

The presentation of fine truffles, an exclusive choice of cheese or simply a single praline – there is a fitting size for each purpose!

The lightweight cloches by Zieher are heat resistant, dishwasher safe and very easy to handle for the guests. Each item is manufactured by hand and therefore shaped individually.

The raw material for these items is borosilicate glass which is mainly used for laboratory dishes. Its main features are a great resistance against heat and changes in temperature as well as a high break resistance. A wine cooler of the same design is available on page 23.



More sizes of the cloches made of glass are available on the following pages.



Ø 5 cm



glass cloche

borosilicate glass, transparent, handblown, handmade

item	Ø in cm	approx. height in cm	PU
4982.05	5	8-9	6 pcs



Ø 6 cm



glass cloche

borosilicate glass, transparent, handblown, handmade

item	Ø in cm	approx. height in cm	PU
4982.06	6	9.5-10.5	6 pcs



miniature plate

white china, flat

item	l x w in cm	PU
4240.10	10x10	12 pcs



Ø 7 cm



glass cloche

borosilicate glass, transparent, handblown, handmade

item	Ø in cm	approx. height in cm	PU
4982.07	7	11-12	6 pcs

miniature plate

white china, flat

item	l x w in cm	PU
4240.10	10x10	12 pcs

miniature plate

white china, flat, oval

item	l x w x h in cm	PU
4324.11	11x9x1.8	12 pcs



small bowl

white china, deep, oval

item	l x w x h in cm	content in l	PU
4326.11	11x9x3.8	0.1	12 pcs



small bowl "Drop"

glass, deep black

item	l x w in cm	PU
5039.01	10x8.5	12 pcs



glass tray

deep black, with 3 round sockets (Ø 6 cm at bottom area)

item	l x w in cm
5145	32x12



miniature plate

glass, deep black, flat

item	l x w in cm	PU
5034.01	10x10	12 pcs



glass platter

deep black, with deepening (Ø 8 cm)

item	l x w x h in cm	PU
5154	29.5x20x3	3 pcs

Ø 9 cm



glass cloche

borosilicate glass, transparent, handblown, handmade

item	Ø in cm	approx. height in cm
4982.09	9	14-16



wind light

borosilicate glass, with 3 notches at the bottom, open at the top, handmade, Ø 9 cm, approx. 12 - 13 cm high

item	version
4987.01	transparent
4987.02	satined (inside)



cloche/small bowl "Amuse"

borosilicate glass, transparent, handblown, single-walled

item	Ø / height in cm	content in l	PU
4916	9 / 6	approx. 0.2	6 pcs



glass insert "Solid"

hardened glass, transparent, with 4 transparent silicone feet, edge polished and deburred, 4 mm thick, for saucer "Solid" item 4700.01

item	Ø in cm	PU
5244.09	9	6 pcs



saucer "Solid"

walnut, food-safe sealed, not dishwasher-safe, Ø inner circle: 9.3 cm, for glass inlay item 5244.09

item	Ø in cm	height in cm
4700.01	15.3	2



saucer

china, black, matt, round, with round deepening (Ø 9.3 cm), for cloches with Ø 9 cm

item	Ø in cm	height in cm	PU
3857	13.5	1.5	6 pcs



Cloches



glass plate

black, flat, hammered optic, dishwasher-safe

item	Ø in cm	PU
5730.18	18	3 pcs



glass plate

black, deep, hammered optic, dishwasher-safe

item	Ø in cm	PU
5731.19	19	3 pcs



items 4982.09 + 3857

The glass platters of the "Ice" series are available on page 177.



Refining upon request.



glass bowl

dark grey, square, structured, for cloches with Ø 11 cm

item	l x w x h in cm	PU
5016.24	24x24x5	2 pcs



tray

massive stainless steel 18/10, round, smooth finish, six times polished, with raised edge, for cloches with Ø 11 cm and 13 cm

item	Ø in cm	height in cm
2188.14	14	1.5

Ø 11 cm



glass cloche

borosilicate glass, transparent, handblown, handmade

item	Ø in cm	approx. height in cm
4982.11	11	17-19



wind light

borosilicate glass, with 3 notches at the bottom, open at the top, handmade, Ø 11 cm, approx. 13 - 14 cm high

item	version
4988.01	transparent
4988.02	satined (inside)



wind light

biscuit china, white, translucent, with a round, oblique opening, suitable for items 4398 and 8043.02

item	Ø in cm	height in cm	PU
4397	11	13.5	6 pcs



saucer

biscuit china, white, inner circle glazed (Ø 9.5 cm), for round items with an inner diameter of 10.5 cm

item	Ø in cm	height in cm	PU
4398	11.5	1.3	6 pcs



glass insert "Solid"

hardened glass, transparent, with 4 transparent silicone feet, edge polished and deburred, 4 mm thick, for saucer "Solid" item 4700.02

item	Ø in cm	PU
5244.11	11	6 pcs



saucer "Solid"

walnut, food-safe sealed, not dishwasher-safe, Ø inner circle: 11.3 cm, for glass inlay item 5244.11

item	Ø in cm	height in cm
4700.02	18.7	2



plate "SelectionA."

white china, with hollow (Ø 9 cm, 0.14 l content), for cloches with Ø 11 cm

item	Ø in cm	PU
4493.24	24	6 pcs

Ø 13 cm



glass cloche

borosilicate glass, transparent, handblown, handmade

item	Ø in cm	approx. height in cm
4982	13	20-23



cloche/small bowl "Amuse"

borosilicate glass, transparent, handblown, single-walled

item	Ø / height in cm	content in l	PU
4917	13 / 7.5	approx. 0.5	4 pcs



glass insert "Solid"

hardened glass, transparent, with 4 transparent silicone feet, edge polished and deburred, 4 mm thick, for saucer "Solid" item 4700

item	Ø in cm	PU
5244	13	6 pcs



saucer "Solid"

walnut, food-safe sealed, not dishwasher-safe, Ø inner circle: 13.2 cm, for glass inlay item 5244

item	Ø in cm	height in cm
4700	22	2



tray

massive stainless steel 18/10, round, smooth finish, six times polished, with raised edge, for cloches with Ø 11 cm and 13 cm

item	Ø in cm	height in cm
2188.14	14	1.5

Cloches



The dinner plate made of natural slate is available on page 53, the saucer made of china on page 192.



The plates of the series "Capiz" are available on pages 174 and 175.



DESIGN
by
ZIEHER

Little somethings perfectly staged!

The thick bottom of the hand-blown bowl leads to a blow-up effect when used as a cloche!



small bowl/cloche

glass, transparent, handblown, for ring

"SelectionA." items 4681... (please order separately)

item	Ø / height in cm	content in l	PU
5418	9 / 6	0.2	6 pcs



ring "SelectionA."

silicone, for the anti-slip placement of small bowl item 5418, Ø 8.3 cm

item	colour	PU
4681.S	black	6 pcs
4681.W	white	6 pcs



saucer

china, black, matt, round, with round deepening (Ø 9.3 cm), for cloches with Ø 9 cm

item	Ø in cm	height in cm	PU
3857	13.5	1.5	6 pcs



glass cloche

transparent, with handle, handblown, for glass stands items 4854... (please order separately)

item	Ø in cm	height in cm
4853	10.5	11.5



glass stand

transparent, with round foot (Ø 8 cm) and platform (Ø 11.5 cm), handblown, for glass cloche item 4853

item	height in cm
4854.01	13
4854.02	16.5
4854.03	23

Food: Pâtisserie Walter
(www.patisserie.de)

These items are handblown and handcrafted.
Minor size tolerances are normal and unavoidable!

Each cloche is handblown and handcrafted. In contrast to our cloches made of borosilicate glass (page 189), these items are made of a massive glass drop. Therefore air inclusions and minor streaks cannot be avoided completely. Each cloche is unique, the result is a harmonic enlivenment of the buffet for an attractive price.



glass cloche

glass, transparent, with round handle, handblown, for saucer "Solid" items 4734...

item	Ø in cm	height in cm
4850	18.5	31
4851	22.5	37
4852	26	43



dinner plate

special hardened safety glass, edge polished, dishwasher-safe, rubber feet included (adhesive), underside scratch-proof, 4 mm thick, Ø 33 cm

item	version
1669.33	black glass
1671.33	white glass



dinner plate

massive stainless steel 18/10, round, hammered finish, six times polished

item	Ø in cm
2161	33



glass cloche

glass, transparent, suitable for pastry/cake stand items 5349...

item	Ø in cm	height in cm
5350.16	16	13
5350.23	23	16.5
5350.27	27.5	20.5



pastry/cake stand

transparent glass, with foot

item	Ø in cm	Ø foot in cm	height in cm
5349.21	21	10.5	9.5
5349.28	28	13	11.5
5349.33	33.5	13	11

The saucer "Solid" items 4734... are available on page 189.



items 4851 + 2161



Example of application:
Presentation of a premium beer type



Making precious materials more precious - whether it is glass or china ...



... everything is possible!

Large-scale coatings on glass and china in precious colours enrich every dining table and create luxurious accents!

In order to achieve this decorative style, available in gold, platinum and bronze, the precious metals are burnt onto the varnish at more than 880 °C and as a result the coating is dishwasher-safe.

Cloches made of glass can now be used for serving warm dishes as well and condensing water remains invisible to a great part.

By using resistant precious alloys we obtain a connection to the varnish which is strong enough for the products to become dishwasher-safe. Test series by the "Institut für Werkstoffe Heraeus Precious Metals GmbH & Co. KG" have proven the dishwasher resistance of the décor.

Partially, the possibilities of coating are dependent on the form of the product.

Requests are being tested in each case according to their feasibility.

The bronze colour is a special case since it presents itself in numerous interesting shades of colour.

Depending on the shape of the product, especially when looking at immersions, the colours can vary from gold-bronze shades to blue-violet ones which blend into each other and create unique effects.

**Since the products are refined in Germany, specific patterns/orders are usually executed quickly.
Please do not hesitate to send us your special request!**



Please note:

Products are dishwasher-resistant. Please take note of the instructions given by dishwasher producers and detergents to avoid damage.

Since the coatings are made of precious metals, the use of microwaves is not recommended under any circumstances.

Dinner plates



The complete "Artisan" series is available on pages 78 and 79.



dinner plate "Artisan"

stainless steel 18/10, round, inside polished, outside matt finish, hammered rim with golden adornment (brass), utility space smooth finish

item	Ø in cm
2375.33	33



dinner plate

massive stainless steel 18/10, round, hammered finish, six times polished

item	Ø in cm
2161	33



dinner plate "Ice"

glass (crimped glass chips), white, round, bevelled edges, dishwasher-safe

item	Ø in cm	height in cm
5760.35	35	2



dinner plate "Ice"

glass (crimped glass chips), white, square, bevelled edges, dishwasher-safe

item	l x w x h in cm
5761.33	33x33x2



glass plate "Ribbon"

dark grey, round, flat

item	Ø in cm	PU
5149.32	32.5	3 pcs

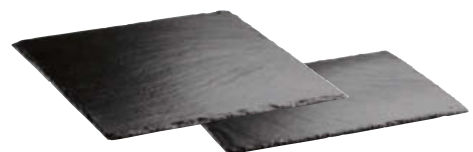

dinner plate

natural slate, food-safe (sealed), with rubber feet, not dishwasher-safe, approx. 5 mm thick

item	version	l x w in cm
2543.30	square	30x30
2544.30	rectangular	30x20

The complete "Ice" series is available on page 177.

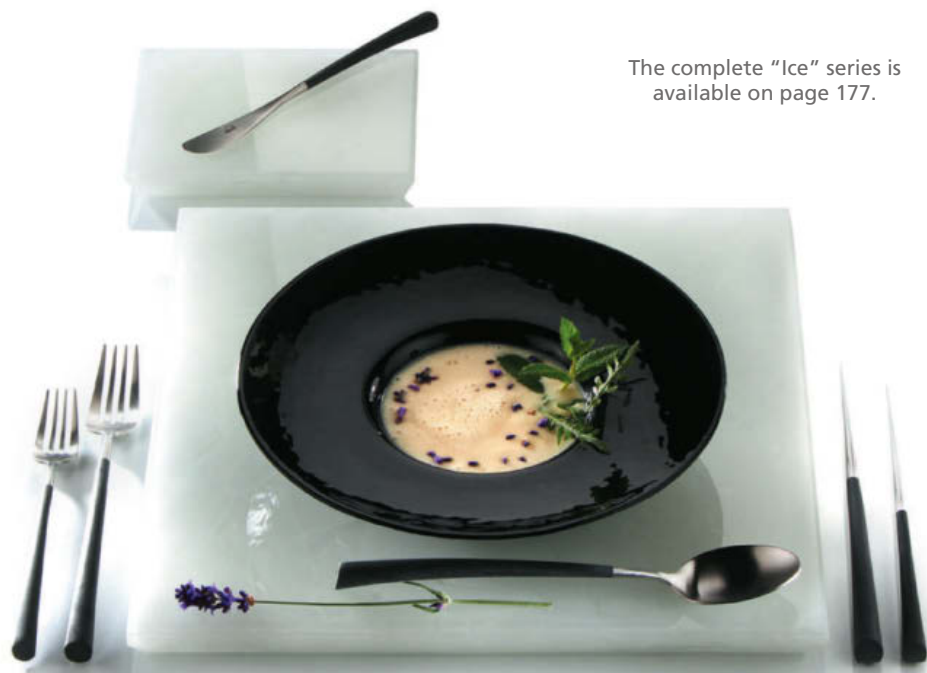



dinner plate

special hardened safety glass, edge polished, dishwasher-safe, rubber feet included (adhesive), underside scratch-proof, 4 mm thick, Ø 33 cm

item	version
1669.33	black glass
1671.33	white glass



dinner plate

hardened glass, transparent, edge polished and deburred, 6 mm thick

item	Ø in cm
4999	33

The double-walled bowl item 4956.01 is available on page 223, the cutlery "Goa" on page 300.



dinner plate

special hardened safety glass, rounded edges, polished rim, dishwasher-safe, rubber feet included (adhesive), underside scratch-proof, 4 mm thick

item	version	l x w in cm
1668.06	black glass	34x34
1668.10	black glass	30x18
1670.06	white glass	34x34
1670.10	white glass	30x18



dinner plate

hardened glass, grey transparent, irregularly coloured in a cloudy look, underside structured, dishwasher-safe, scratch-proof

item	l x w in cm	thickness in mm
8008.06	34x34	5



dinner plate

laminated plastic, black intermediate ply, deburred edges, rounded corners, break-proof, scratch-proof, dishwasher-safe, antistatic, 8 mm thick

item	version	l x w in cm
8002.06	old varnish white	34x34
8003.06	rusted look	34x34



"DressCoat" is available on pages 150 and 151.

The creamer is available on page 220.

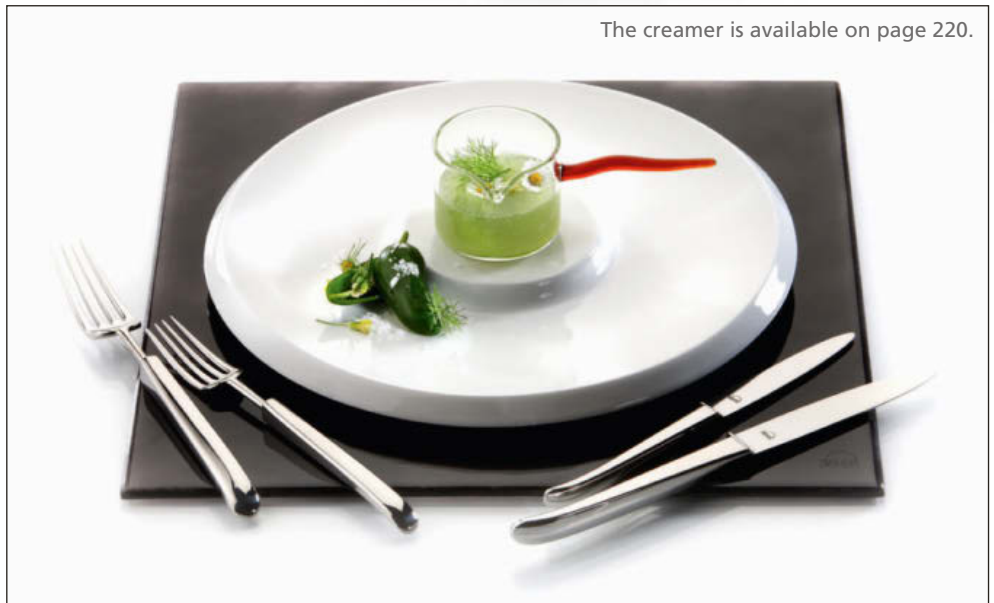

All platters made of laminated plastic are available on pages 54 and 55.



"Plat de Luxe"

The complete series "Plat de Luxe" is available on pages 158 and 159.



plate "Plat de Luxe"
white china, flat

item	Ø in cm	PU
4520.32	31.6	6 pcs



plate "Plat de Luxe"
white china, flat, with decor "geo" (white)

item	Ø in cm	PU
4520.32D1	31.6	6 pcs



plate "Plat de Luxe"
white china, flat, with decor "free" (black)

item	Ø in cm	PU
4520.32D2	31.6	6 pcs





The saucer made of china and the suitable cloche is available on page 194.

"Capiz"



dinner plate "Capiz"

shell, ivory-coloured, resin-coated, organically shaped, not dishwasher-safe

item	Ø in cm	PU
7100.31	31	2 pcs
7100.36	36	2 pcs

More items of the series "Capiz" are available on pages 71, 174 and 175.



dinner plate "Capiz"

shell, ivory-coloured, resin-coated, not dishwasher-safe

item	Ø in cm	PU
7115.36	36	2 pcs



dinner plate "Capiz"

shell, taupe-coloured, resin-coated, not dishwasher-safe

item	Ø in cm	PU
7116.36	36	2 pcs



The glass plates are available on page 176, the cloche "Amuse" on page 216.

Please note the care instructions: suitable for cold and dry food, not dishwasher-safe.

VAGANZA

DESIGN
by
ZEHER



The filigree champagne flute "Vaganza" is handblown and created in superior handicraft by experienced glassblowers. The result of this work is a crystal glass of highest craftsmanship. "Vaganza" captivates by its slim silhouette and elegant shape that bestows an exclusive character on the glass. The versions coated in gold or platinum fascinate with brilliant colours and the luxurious appearance of the applied decors. "Vaganza" seduces by its charming lightness and adds a touch of high society to any event.



champagne flute "Vaganza"

crystalline glass, Ø 5 cm, 33.5 cm high,
210 ml content, handblown, in black gift box

item	colour	PU	
5481	transparent	2 pcs	
5481.GPB	gold	2 pcs	
5481.PPB	platinum	2 pcs	



“YOU HAVE NEVER SEEN WINE LIKE THIS!”

VISION

Silvio Nitzsche, WEIN | KULTUR | BAR Dresden

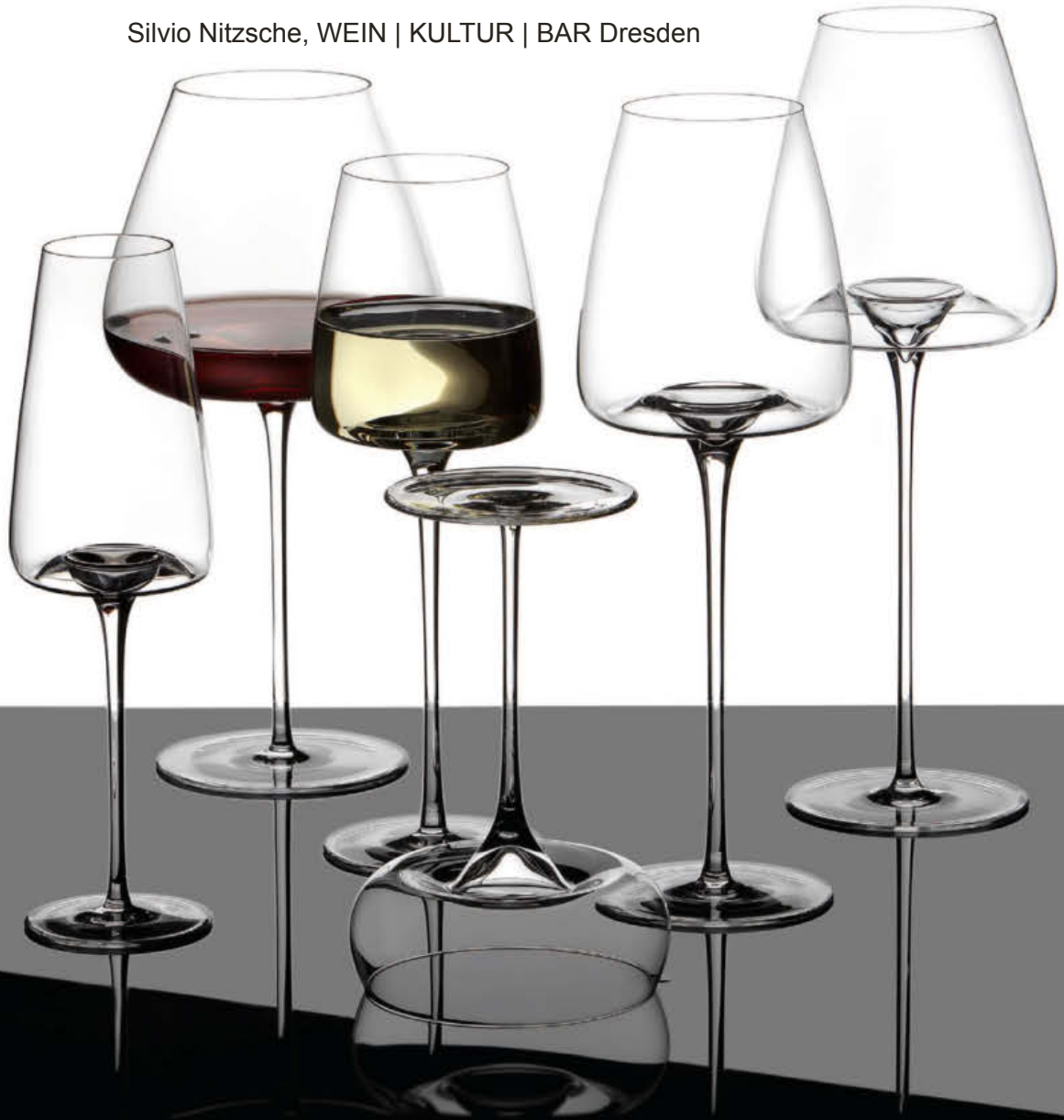

“My whole team and I myself are convinced that the beautiful glasses of the VISION series represent a new league of wine glasses. We also receive a lot of positive feedback from our guests.”

- GÜNTER SEEGER, NEW YORK

The restaurant “Guenter Seeger” in New York City has been awarded multiple times by: Michelin Star and James Beard Award.

www.gunterseegerny.com

“From the very beginning we have been excited by the appearance and the design of the glasses. But after the first degustation we have been enthusiastic! We did not want to stop tasting. The wine simply gains a different character. The BALANCE glass makes decanting superfluous - and a Grappa out of the RICH glass is simply a great experience!”

- THOMAS DÖTZER, BAYREUTH, GERMANY

Top chef at Bayreuth, food stylist, wine expert and entrepreneur

www.doetzers.de

“I realized in the very first moment, when taking the first sips out of these glasses, that the VISION glasses are something very special. The glasses appear distinctively light and precious and are a real eyecatcher, but this is of minor importance to me. The crucial point is that even the taste of the best wine can be enhanced by drinking it out of the proper VISION glass.”

- HERMANN PFLAUM, PEGNITZ, GERMANY

Franconian top chef and author of cooking books, founder of the legendary “Pflaums Posthotel”, Pegnitz, co-founder of the nouvelle cuisine and of the “German Academy for Culinary Studies”.



For further information about the VISION series, philosophy and far-reaching analysis of the sommelier Silvio Nitzsche please visit www.zieher.com/en/products/vision.html.

skillfully handblown

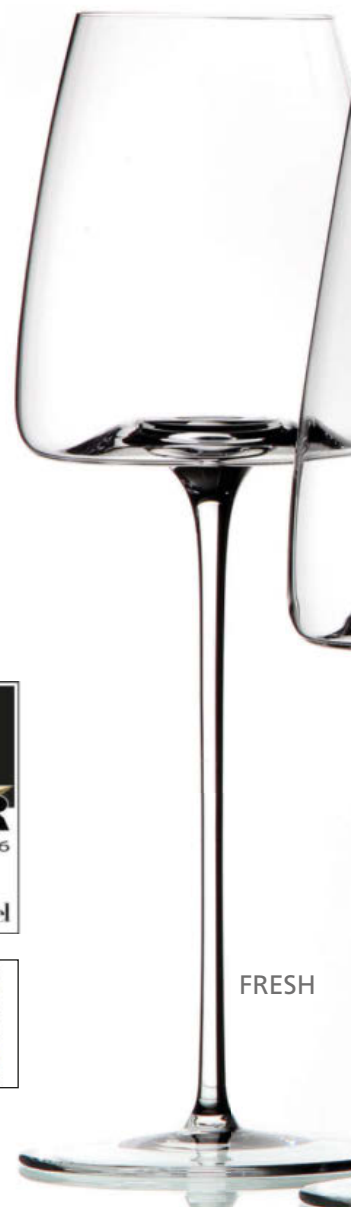

FRESH



“YOU HAVE NEVER SEEN WINE LIKE THIS!”

Silvio Nitzsche, WEIN | KULTUR | BAR Dresden



The Life and Work of Silvio Nitzsche

“Of course, there is life without wine, but who wants that?”

During a career as a sommelier, which has spanned more than twenty years, Silvio Nitzsche has looked after both guests and wine in some of the best Michelin-starred restaurants.

Some of his high-profile positions have been:

- Sommelier at “Dieter Müller Restaurant” (19.5 GM, *** Michelin), Bergisch Gladbach / GER
- Sommelier at “Erna’s Elderberry House”, Oakhurst / CA, USA
- Assistant Restaurant Manager and Sommelier at “Speisemeisterei” Restaurant (18 GM, ** Michelin), Stuttgart / GER

Silvio Nitzsche has now found a new home in the city of Dresden, where he has worked as a sommelier for almost ten years. At the WEIN | KULTUR | BAR that he opened there, he and his team have managed to establish a wine bar that many wine enthusiasts consider to be one of the best in Europe. He has succeeded in creating a place where wine is a permanent feature.

www.weinkulturbar.de



Filigree Craftsmanship meets Innovative Design

"Zieher glasses are all about top quality craftsmanship, which is created in one of the most innovative and best glass blowing workshops in the world. Each glass is unique and has been created from lead-free crystalline glass using a traditional glass-blowing method.

As well as having a perfect, highly sophisticated and fascinating design, the glasses in the VISION range are guaranteed to provide maximum aroma and optimum development of the wine. However, it is particularly the fascination of the light, the colours and the visual depth that make it impossible to tear your eyes away from the glass, because: You have never seen wine like this!"

The Vision

"No distinction is made between red wine or white wine glasses in this collection, the glasses are simply theme-based or character-based. The names of the glasses clearly explain what they are used for: You intuitively reach for the glass which in the best way presents the flavours of the wine that you particularly wish to emphasise. If you want a powerful wine to be more harmonious or a touch more lively and fresh, you pick the glass with the designation that mirrors your requirement best."

Silvio Nitzsche

The Zieher Food - VISION

The series VISION is predestined for wine and has been created to perfectly represent its different facets. In addition to this, the glasses offer an extraordinary platform for small delicacies or complimentary dishes from the chef. The harmonic way shape of the bottom creates an eye-catching ring when filled with spume or liquids. The depression in its centre provides space for amuse bouche or decorative highlights.



For distributors:
Sample case VISION item 5661.01.
We will be happy to inform you!



FRESH

crystalline glass, transparent, handblown

item	Ø / height in cm	content in ml	PU
5480.01	8 / 24	approx. 340	2 pcs

For extremely fresh white wines, Prosecco or any variety of sparkling wine, and light rosé wines

The wide opening of this glass allows the carbon dioxide in sparkling wines to gently evaporate. This prevents the aroma perception of the nose from being broadsided by a concentration of carbon dioxide, which is often the case with classic sparkling wine glasses. The glass provides the palate with a centralised aroma concentration, which allows the wine to express its exquisitely lively, refreshing and light character. The development of the flavour-carrying, freshly acidic structures is encouraged, and individual features of the bouquet are brought into focus.



STRAIGHT

crystalline glass, transparent, handblown

item	Ø / height in cm	content in ml	PU
5480.02	9 / 27	approx. 540	2 pcs

For pure grape varieties and fruity / aromatic red and white wines

The characteristics of the wine are reflected harmoniously one-to-one in this glass. The authenticity of the aroma culture of a grape variety is made discernible and presented in an unpretentious way, which makes this glass particularly suitable for all types of authentic grape varieties such as Riesling or Sauvignon Blanc. Light, aromatic red wines are transformed into pure drinking enjoyment.



INTENSE

crystalline glass, transparent, handblown

item	Ø / height in cm	content in ml	PU
5480.03	10.5 / 28	approx. 640	2 pcs

For opulent, great growth, powerful white and red wines, rustic, acidic white and red wines, young and middle aged Bordeaux wines

The tapering neck of this glass intensifies the aroma molecules, which are positively hurled out of the glass. The acidity is harmoniously structured in the fruit bouquet, and completes the opulent overall sensation of strength. The glass provides intensive oxidation, making it ideal for any wine that can be decanted or served in carafes.



BALANCED

crystalline glass, transparent, handblown

item	Ø / height in cm	content in ml	PU
5480.04	12 / 25	approx. 850	2 pcs

For white and red Burgundy, great Piedmontese wines, highly complex but sensitive white and red wines, extremely opulent rosé wines and old vintage champagne

A perfect glass for wine that is not for decanting because of its sensitive structure, but still requires a great deal of air. This crystal emanates pure consonance. Even with discordant wines, it succeeds in creating a concentrated and highly elegant impression. This glass turns wine into a complete aromatic experience, without overdoing it.

RICH

crystalline glass, transparent, handblown

item	Ø / height in cm	content in ml	PU
5480.05	7 / 23	approx. 280	2 pcs

For fortified, sweet and dessert wines and any type of distilled beverages

A glass for the majority of heavyweight or high-proof drinks. The small presentation surface ensures that the wine or brandy does not become overly concentrated, so that the heavyweight aromatic elements are released in a nuanced way. Due to the glass having a narrow opening, the nose cannot go in very far, which prevents the perceiving mucous membranes from receiving a barrage of alcohol.

NOSTALGIC

crystalline glass, transparent, handblown

item	Ø / height in cm	content in ml	PU
5480.06	10.5 / 16.5	approx. 250	2 pcs

For mineral water, cocktails, or as a food glass

A glass which manages to distinguish any mineral water with its extremely open chalice design, which appeals to an extensive palate. The acids and the individual, extremely fine mineral elements of the water are delivered to the tongue and the palate in a refreshing way. At the same time, the carbon dioxide is harmonised and has an extremely refreshing effect, but avoids being penetrating, flavour-destroying or intrusive.

For the series VISION we recommend the

CAMBRO - Camrack® Warewashing System

MANUFACTURING COMPANY

The Camrack® Warewashing System will protect your valuable stemware and tumblers not only during washing, but also during stacking, storage and transportation. This helps to avoid costs related to damaged glasses. Detailed information about the Camrack® Warewashing System is available at www.cambro.com.

Camrack® 4-in-1 Warewashing System

- Efficient washing
- Optimum sanitary storage
- Inventory control
- Safe, sanitary transportation

Camrack® Warewashing System

Cambro® offers a 4-in-1 system where glassware is washed, stored, identified and transported in one single unit. This multipurpose unit involves the Camdolly®, Camrack® compartment racks and the Camrack® cover.



item racks	number of compartments	max. height	max. Ø	rack height	for item	name
25S958	25	25.8 cm	8.7 cm	30.8 cm	5480.01	FRESH
20S1114	20	30 cm	9.8 cm	34.9 cm	5480.02	STRAIGHT
16S1114	16	30 cm	10.9 cm	34.9 cm	5480.03	INTENSE
9S958	9	25.8 cm	14.8 cm	30.8 cm	5480.04	BALANCED
30S958	30	25.8 cm	7.9 cm	30.8 cm	5840.05	RICH
16S638	16	17.4 cm	10.9 cm	22.5 cm	5480.06	NOSTALGIC

Accessories - Dolly and Cover



Camdolly®

item	l x w x h in cm	colour
CDR2020	54.3x54.3x20.3	soft grey (151)



Camrack® Cover

item	l x w x h in cm	colour
DRC2020	50x50x2.4	grey (180)



VISION



New



decanter/carafe "Eddy"

borosilicate glass, transparent, handblown

item	Ø in cm	height in cm	content in l
4883	17	33	approx. 2.3



pedestal/ring

silicone, optionally available pedestal for positioning the decanter item 4883 at an angle, Ø 13.4 cm

item	colour	PU
4682.S	black	3 pcs
4682.W	white	3 pcs

"The decanter "Eddy "defines the world of extreme wine instruments in a completely new way. Outstanding functionality combined with a language of design on an aesthetic level, which has seldom been achieved for wine instruments in such a fascinating way. It is amazing which matchlessly fast-paced development of structure each wine, no matter if red, white or rosé, experiences in this respirator. Once rotating in this texture stimulator, the wine – within seconds - runs through a development, which leads to an oxidation reaction of several hours, due to the thousandfold swirls at the conical indentations."

Silvio Nitzsche - WEIN | KULTUR | BAR - Dresden, Germany



New



decanter/carafe "Eddy" with ring

set consists of:

decanter made of borosilicate glass, transparent, handblown, approx. 2.3 l content

ring made of silicone, black

1 set in black gift box

item	Ø in cm	height in cm	PU
4884.PB	17	35	1 set (2 parts) 📦

As opposed to most of the decanters available on the market, the raw material of this development aid worker for wine is not crystal glass, but high-grade and robust borosilicate glass. This type of glass, which stands out due to its dense structure, extraordinary transparency and hardness, was the precondition for the implementation of the introversive swirl elements. In an interplay with light and the contained wine, they create also visually interesting colour reflections and formal, almost graphic effects. The volume of this respirator has been dimensioned in a way that, with a filling of up to 1.5 litres, the extension of the wine's surface becomes as large as possible. Due to the complanate bottom the decanter stands safely and straight, the enclosed base made of finely structured matt black silicone also allows an inclined positioning.

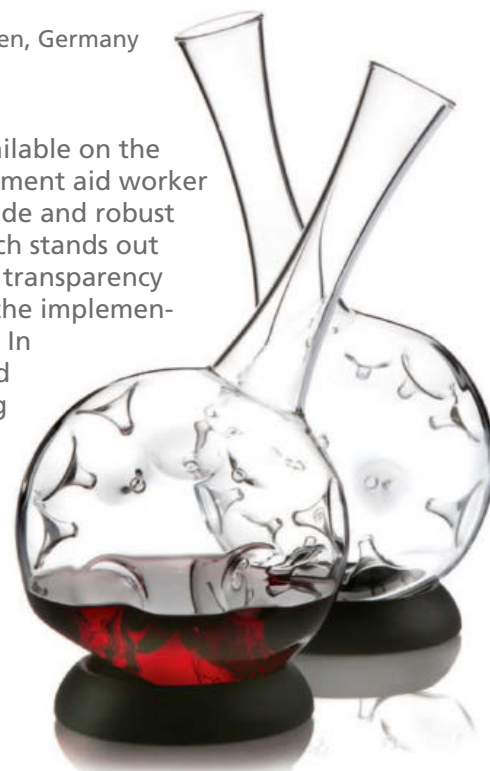

No sliding,
no clattering ...

The china series "DressCoat" is available
on pages 150 and 151.



... with the non-slip pads by Zieher!

The coasters made of food safe silicone are shapely accessories with a highly practical benefit. Clattering and wildly sliding miniatures on plates and trays are a thing of the past.

The skid-proof discs with their delicately structured, matt surface facilitate the service's work and ensure undisturbed enjoyment for the guest.

The coasters are available in two colours and diameters (Ø 5 and Ø 7 cm); the white ones can be integrated discreetly, whereas the black ones can be used deliberately as contrasting, decorative elements.

The glass plates are available on page 176,
the glass cloche on page 193.



coaster

silicone, temperature resistant (-40 °C to +230 °C), food-safe, with rim on one side, for anti-slip placement of miniatures, Ø 5 cm, 3 mm thick

item	version	PU
4661.05S	black	24 pcs
4661.05W	white	24 pcs



coaster

silicone, temperature resistant (-40 °C to +230 °C), food-safe, with rim on one side, for anti-slip placement of miniatures, Ø 7 cm, 3 mm thick

item	version	PU
4661.07S	black	24 pcs
4661.07W	white	24 pcs

Miniatures



"Good taste is the art of understanding small things."

Rousseau

"Cuspis"



New!

glass spoon "Cuspis"

borosilicate glass, transparent, handblown, with star-shaped ball handle

item	l x w x h in cm	PU
4941.01	approx. 7x4x3.5	6 pcs



New!

honey spoon "Cuspis"

borosilicate glass, transparent/white, handblown, star-shaped, please note the safety instructions on each pack

item	length in cm	PU
4942.01	16	4 pcs



New!

small tray/glass coaster

glass, deep black, rectangular

item	l x w x h in cm	PU
5167	11.5x5.5x1.5	12 pcs

A honey spoon of a different kind reliably holds the honey and, while being twirled, will deliver it drip-free onto the fresh bread or into the tea. The tapering handle made of white borosilicate glass additionally offers the use as a skewer - for an extravagant presentation of dishes. The gift set includes a tray made of black glass, which keeps the surface of tables clean and emphasizes the spoon by creating an appealing contrast. The tray is also available separately.



The glass pillow „Donna” is available on page 143.



New!

honey spoon with glass tray "Cuspis"

set consists of:

honey spoon made of borosilicate glass, transparent/white, handblown, star-shaped

tray made of glass, deep black, rectangular

1 set in black gift box

item	l x w x h in cm	length (spoon) in cm	PU
4944.PB	11.5x5.5x1.5	16	1 set (2 parts) 📦

New!



glass cloche "Cuspis"

borosilicate glass, transparent, handblown, star-shaped ball handle

item	for plate/bowl	Ø in cm	height in cm
4940.08	4389.09	8.5	12.5
4940.10	4389.11	10.5	14.5



New!



plateau plate/small bowl "Cuspis"

white china, inside and useable area (plateau Ø approx. 6 cm/8 cm) glazed, outside biscuit, also useable as a bowl

item	Ø in cm	height in cm	content in l
4389.09	9	3	0.1
4389.11	11.5	3.5	0.18



New!



cloche with plateau plate/small bowl "Cuspis"

set consists of:

cloche made of borosilicate glass, transparent, handblown, with star-shaped ball handle

plateau plate made of white china, inside and useable area glazed, outside biscuit, useable on both sides

1 set in black gift box

item	Ø in cm	height in cm	PU
4943.08PB	9	approx. 14/14.5	1 set (2 parts)
4943.10PB	11.5	approx. 17/17.5	1 set (2 parts)

Borosilicate glass in its most beautiful shape!

The primary design element of the series "Cuspis" is a glass ball studded with fine spikes. The cloches with a fitting porcelain plateau plate/mini bowl are available in three sizes and the inspiration for their shaping was derived from the nut of the oak tree. The star-shaped handle is located at the top of the cloches and allows for an uncomplicated handling of these classy covers. The unglazed outside of the porcelain bowls is reminiscent of acorn caps. The bowls can be used on both sides. When used as a plateau plate, the dishes move closer to the guest, while the filigree glass cloche protects the presented delicacies and puts them in the limelight at the same time.

Used as a bowl, it offers space for gravies, sauces and more. Amuse-bouches and any kind of finger food can be served on the series' shapely amuse gueule spoons.

In this case the glass ball serves as a secure handle. The capacity of the spoons is sufficient for a usage with sauces or dips on the plate, but also at the breakfast buffet for jam and the like.



The large cloche "Cuspis" and the suitable plateau plate are available on page 144.

The black glass tray item 5141.26 is available on page 276.



"Lacuna"



glass straw

borosilicate glass, transparent, handblown, temperature resistant, please note the safety instructions on each pack of glass straws

item	length in cm	Ø in cm	PU
4980.16	16	0.8	24 pcs



small bowl

china, black, matt, square

item	l x w x h in cm	content in l	PU
3855.01	4.9x4.9x7	0.11	4 pcs



holder for test tubes

silicone, with grooves on the inside for easy insertion of glass tubes, Ø 4.6 cm, 2.7 cm high

item	colour	PU
4680.S	black	6 pcs
4680.W	white	6 pcs



glass

transparent

item	Ø / height in cm	content in l	PU
5405	5 / 8.6	0.1	6 pcs



glass miniature

transparent

item	Ø / height in cm	content in l	PU
5408.02	4.6 / 9.3	0.09	6 pcs



miniature

china, stackable, Ø 5.3 cm, 7 cm high, 0.1 l content

item	colour	PU
4490	white	6 pcs
4490.01	black	6 pcs



"Lacuna"

Braving the gap!

Perforated walls, irregularly spread openings in filligree borosilicate glass – the small bowls of the series "Lacuna" stand out. Numerous holes in different sizes form the basis for sophisticated presentations of high-grade dishes. They set limits on the one hand, however offer various possibilities for creative arrangements and an extraordinary food presentation on the other.

The glass cone can be employed in three different ways. Rested horizontally and stabilized by a fork or a spoon, standing upright in various miniatures or put in elegant supports made of silicone or as an extraordinary cloche for the presentation of delicate tidbits.

Suitable accessories like anti-slip coasters made of food safe silicone or borosilicate glass straws enormously extend the scope of application of that series. Even working with small skewers for finger food may be envisaged.



DESIGN
by
ZEHER



Design: Michael Schwarzmüller



New!

cone "Lacuna"

borosilicate glass, transparent, handblown, with line of holes along the rim

item	Ø / height in cm	content in l	PU
4925.01	6 / 12	approx. 0.08	4 pcs



New!

small bowl "Lacuna"

borosilicate glass, transparent, handblown, with line of holes along the rim

item	Ø / height in cm	content in l	PU
4926.01	12.5 / 6	approx. 0.08	4 pcs



The platter "Rough!" is available on page 147.

"Amuse"

The series "Plat de Luxe" is available on pages 158 and 159.



glass miniature "Amuse"

borosilicate glass, transparent, handblown, single-walled, rim jagged

item	l x w x h in cm	content in l	PU
4924.01	13x9.5x6	approx. 0.15	6 pcs
4924.02	15x10.5x7	approx. 0.25	4 pcs

glass miniature "Amuse"

in black gift box

item	l x w x h in cm	content in l	PU
4924.01PB	13x9.5x6	approx. 0.15	1 pc.
4924.02PB	15x10.5x7	approx. 0.25	1 pc.



The saucer made of slate is available on page 242.



cloche/small bowl "Amuse"

borosilicate glass, transparent, handblown, single-walled

item	Ø / height in cm	content in l	PU
4916	9 / 6	approx. 0.2	6 pcs
4917	13 / 7.5	approx. 0.5	4 pcs

More glass cloches are available on pages 188 to 195.



Glass designer Michael Schwarzmüller puts delicious appetizers perfectly into focus. The filigree jars with their organic form offer top chefs and professional hosts the possibility of serving fingerfood and amuse bouche in an "Amuse"-ing way.

"Amuse" wants to inspire imagination and stimulates playful experimentation. This series made of thin-walled, strong and heat-resistant borosilicate glass comprises of a variation of beautifully handcrafted cups, bowls, cloches and remarkable glass tins. The latter are perfectly suitable for the presentation of small soups and desserts, but may also be used as exceptional sugar bowls. The exact fitting lid ensures the protection and hygiene of the content. The double-walled bowls of the series in fact absorb heat or cold.

Please note: since all glasses of this series are handblown, deviations from the declared content may occur.





glass miniature "Amuse"

borosilicate glass, transparent, handblown, oval, single-walled

item	Ø / height in cm	content in l	PU
4912	6 / 7.5	approx. 0.11	6 pcs



glass miniature "Amuse"

borosilicate glass, transparent, handblown, double-walled

item	Ø / height in cm	content in l	PU
4914	8.5 / 7.8	approx. 0.19	6 pcs

The glass bowls are available on page 216.

glass miniature "Amuse"

in black gift box

item	Ø / height in cm	content in l	PU
4914.PB	8.5 / 7.8	approx. 0.19	1 pc.



glass miniature "Amuse"

borosilicate glass, transparent, handblown, double-walled

item	Ø / height in cm	content in l	PU
4915	11.5 / 6.5	approx. 0.25	6 pcs

glass miniature "Amuse"

in black gift box

item	Ø / height in cm	content in l	PU
4915.PB	11.5 / 6.5	approx. 0.25	1 pc.

Design: Michael Schwarzmüller



glass tin "Amuse"

borosilicate glass, transparent, handblown, with lid (black handle, height without lid: 7 cm), 6 feet of glass, in black gift box

item	Ø in cm	height in cm	content in l
4918.PB	6.5	11	approx. 0.14



glass tin "Amuse"

borosilicate glass, transparent, handblown, with lid (black handle, height without lid: 9.5 cm), 6 feet of glass, in black gift box

item	Ø in cm	height in cm	content in l
4919.PB	8	13.5	approx. 0.28



glass tin "Amuse"

borosilicate glass, transparent, handblown, smooth, with lid (black handle, height without lid: 6.5 cm)

item	Ø in cm	height in cm	content in l
4920	8	10	approx. 0.22

glass tin "Amuse"

in black gift box

item	Ø in cm	height in cm	content in l
4920.PB	8	10	approx. 0.22



glass tin "Amuse"

borosilicate glass, transparent, handblown, smooth, with lid (black handle, height without lid: 5.5 cm)

item	Ø in cm	height in cm	content in l
4921	9	9	approx. 0.24

glass tin "Amuse"

in black gift box

item	Ø in cm	height in cm	content in l
4921.PB	9	9	approx. 0.24



items 4920 + 5145

The glass tray and more suitable inserts are available on pages 274 and 275.



The plate of the series "SelectionA." is available on page 168, the glass platter on page 199.



creamer

borosilicate glass, transparent, handblown, handle curved and amber-coloured (approx. 7 cm long)

item	Ø / height in cm	content in l	PU
4995	6 / 5	approx. 0.1	4 pcs



creamer "Amuse"

borosilicate glass, transparent, handblown, single-walled, Ø opening on top approx. 3 cm

item	Ø / height in cm	content in l	PU
4922	8.5 / 8	approx. 0.25	6 pcs



nut bowl "Amuse"

borosilicate glass, transparent, handblown, single-walled, Ø opening on top approx. 3.5 cm

item	Ø / height in cm	content in l	PU
4923	8.5 / 8	approx. 0.2	6 pcs

nut bowl "Amuse"

in black gift box

item	Ø / height in cm	content in l	PU
4923.PB	8.5 / 8	approx. 0.2	1 pc. 

The glass tray is available on page 276.



Double-walled thermo-glasses

Handblown, double-walled glasses made of borosilicate glass combine spectacular optics and extraordinary technical features.

The vacuum between the two glasses prevents the formation of condensate on the outside of the glass when the ambient temperature is warm and the drinks are cold. The isolation effect keeps cold and warm liquids cold or warm for a longer time. Borosilicate glass by Zieher stands out due to its hardness and high temperature resistance.





glass straw

borosilicate glass, transparent, handblown, temperature resistant, Ø 0.8 cm, please note the safety instructions on each pack of glass straws

item	length in cm	PU
4980.08	8	24 pcs
4980.12	12	24 pcs
4980.16	16	24 pcs



cocktail glass

borosilicate glass, transparent, handblown, double-walled

item	Ø / height in cm	content in l	PU
4962	10.5 / 16	approx. 0.2	6 pcs



longdrink glass

borosilicate glass, transparent, handblown, double-walled

item	Ø / height in cm	content in l	PU
4908	7.8 / 15.5	approx. 0.35	6 pcs



glass tumbler

borosilicate glass, transparent, handblown, double-walled

item	Ø / height in cm	content in l	PU
4907	8 / 10	approx. 0.28	6 pcs

The fondue set is available on page 163.



The silicone ring is available on page 230.



fondue insert

borosilicate glass, transparent, handblown, double-walled, for fondue item 4359 and silicone ring "SelectionA." items 4681...

item	Ø / height in cm	content in l	PU
4958	11 / 5.5	approx. 0.1	6 pcs



glass miniature

borosilicate glass, transparent, handblown, double-walled, with reinforced rim

item	Ø / height in cm	content in l	PU
4901.03	5.7 / 7.5	approx. 0.08	6 pcs



The glass platter is available on page 185.



small bowl "SelectionA."

borosilicate glass, transparent, handblown, double-walled

item	Ø / height in cm	content in l	PU
4957	9.7 / 3.5	approx. 0.07	6 pcs



glass miniature

borosilicate glass, transparent, handblown, double-walled

item	Ø / height in cm	content in l	PU
4903	5.5 / 8.5	approx. 0.1	6 pcs



glass miniature

borosilicate glass, transparent, handblown, double-walled

item	Ø / height in cm	content in l	PU
4901.01	6 / 5	approx. 0.08	6 pcs
4901.02	8.8 / 7.5	approx. 0.21	6 pcs



bowl

borosilicate glass, transparent, handblown, double-walled

item	Ø / height in cm	content in l	PU
4956.01	9 / 4.5	approx. 0.07	6 pcs
4956.02	11 / 5.5	approx. 0.15	6 pcs
4956.03	13 / 6.5	approx. 0.25	4 pcs
4956.04	15 / 7.5	approx. 0.30	4 pcs

bowl

in black gift box

item	Ø / height in cm	content in l	PU
4956.02PB	11 / 5,5	approx. 0.15	1 pc.
4956.03PB	13 / 6.5	approx. 0.25	1 pc.
4956.04PB	15 / 7.5	approx. 0.30	1 pc.



small bowl "Halfmoon"

borosilicate glass, transparent, handblown, double-walled

item	Ø / height in cm	content in l	PU
4954.01	6 / 7.5	approx. 0.08	6 pcs
4954.02	8 / 9	approx. 0.17	6 pcs
4954.03	9 / 9.5	approx. 0.21	6 pcs

small bowl "Halfmoon"

in black gift box

item	Ø / height in cm	content in l	PU
4954.03PB	9 / 9.5	approx. 0.21	2 pcs



small bowl "Halfmoon"

borosilicate glass, inside with satin finish, handblown, double-walled

item	Ø / height in cm	content in l	PU
4964	12 / 7.5	approx. 0.35	6 pcs



small bowl

borosilicate glass, inside with satin finish, handblown, double-walled

item	Ø / height in cm	content in l	PU
4963.01	6 / 8	approx. 0.05	6 pcs
4963.02	6.5 / 9	approx. 0.08	6 pcs
4963.03	7.5 / 10.5	approx. 0.1	6 pcs



© Copyright 2012 by Fabian Sängler
www.chocolate-culinary.com
Book title: Sweet Inspirations

Please note: since all double-walled glasses are handblown, deviations from the declared content may occur.

The mini fork "Europa" is available on page 240.



More information about "Flow" is available on page 171.



small bowl

borosilicate glass, handblown, round

item	Ø / height in cm	content in l	PU
4930	7 / 5	approx. 0.14	24 pcs



glass bowl

borosilicate glass, flat

item	Ø / height in cm	content in l	PU
4910	10.5 / 2.5	0.18	12 pcs



glass tube "Sauce Flow"

borosilicate glass, open at the top and at the bottom

item	Ø / height in cm	content in l	PU
4990.01	3 / 5.5	0.02	6 pcs
4990.02	5 / 5.5	0.1	6 pcs



glass tube "Soup Flow"

borosilicate glass, open at the top and at the bottom

item	Ø / height in cm	content in l	PU
4989	6.5 / 11	0.4	6 pcs



test tube

borosilicate glass (temperature change resistant), with flanged rim and round bottom, suitable for holder for test tube items 4680... and cork item 1501

item	content in l	PU
4032.G	0.04	24 pcs

cork

for test tube item 4032.G

item	Ø in cm	length in cm	PU
1501	2.0/1.7	2.6	24 pcs

The silicone holders for test tubes are also suitable as adjustable feet.

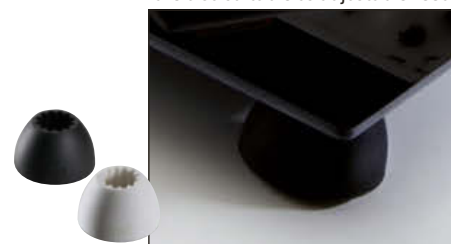

holder for test tubes

silicone, with grooves on the inside for easy insertion of glass tubes, Ø 4.6 cm, 2.7 cm high, for test tube item 4032.G

item	colour	PU
4680.S	black	6 pcs
4680.W	white	6 pcs



small bowl/miniature

glass, transparent, oval

item	l x w x h in cm	content in l	PU
5422	8.3x7.3x3.4	0.05	6 pcs



glass miniature

transparent, wavy rim, base: 0.07 l content, top part: 0.04 l content, for bridge "Modul" items 4584 and 4724

item	version	Ø / height in cm	PU
5423.01	base	6.5 / 5.5	12 pcs
5423.02	top	6.3 / 4.5	12 pcs



New!

glass miniature

glass, satined, wavy rim, two-part

item	Ø / height in cm	content (base) in l	PU
5445	5.5 / 7.5	approx. 0.05	6 pcs



glass miniature

transparent, suitable for stainless steel stands items 3468... and 2058

item	Ø / height in cm	content in l	PU
5420	8 / 5	0.13	6 pcs

glass miniature "Milky"

glass, frosted look, suitable for stainless steel stands items 3468... and 2058

item	Ø / height in cm	content in l	PU
5420.01	8 / 5	0.13	6 pcs



The cutlery "Mao" is available on pages 298 and 299.



The bread basket "Solid" is available on page 251.



small bowl

china, square, 7 cm long, 7 cm wide, 4.5 cm high, 0.13 l content

item	version	PU
3854	white	4 pcs
3854.01	black	4 pcs



small bowl

white china, square

item	l x w x h in cm	content in l	PU
3853	7x7x2	0.05	12 pcs



small bowl

white china, square

item	l x w x h in cm	content in l	PU
3859	6.5x6.5x2	0.03	12 pcs



small bowl

white china, rectangular

item	l x w x h in cm	content in l	PU
3858	13.5x6.5x2	0.07	12 pcs



small bowl

china, square, 4.9 cm long, 4.9 cm wide, 7 cm high, 0.11 l content

item	version	PU
3855	white	4 pcs
3855.01	black	4 pcs



small bowl

china, square, 4.9 cm long, 4.9 cm wide, 4.5 cm high, 0.05 l content

item	version	PU
3845	white	4 pcs
3845.01	black	4 pcs



small creamer

white china, square

item	l x w x h in cm	content in l	PU
3849	4.9x4.9x4.5	0.05	4 pcs



small bowl

white china, square

item	l x w x h in cm	content in l	PU
3844	4x4x3	0.03	24 pcs

The glass bottle is available on page 228, the box "Solid" on page 249.





glass box

transparent, square, delivery without lid item 5338.01 (please order separately)

item	l x w x h in cm	content in l	PU
5338	7x7x3.9	0.1	12 pcs

glass miniature

transparent, lid for glass box item 5338

item	l x w in cm	PU
5338.01	7x7	12 pcs



small bowl

glass, transparent, square

item	l x w x h in cm	content in l	PU
5258	7x7x4.5	0.13	12 pcs



small bowl

glass, transparent, square, delivery without lid item 5254.01 (please order separately)

item	l x w x h in cm	content in l	PU
5254	4.9x4.9x4.5	0.05	4 pcs



small creamer

glass, transparent, square, delivery without lid item 5254.01 (please order separately)

item	l x w x h in cm	content in l	PU
5255	4.9x4.9x4.5	0.05	4 pcs



glass miniature

transparent, lid for mini bowl items 5254 and 5255

item	l x w in cm	PU
5254.01	4.9x4.9	12 pcs



glass platter

transparent, square

item	l x w x h in cm	PU
4812.08	8x8x1.2	6 pcs
4812.10	10x10x1.3	6 pcs

Also suitable for tealights



jam tray

glass, transparent, 4 deepenings (Ø 4.6 cm), for inserts and portion jam up to Ø 4.4 cm (e. g. "Darbo" portion jam, 28 g and 40 g)

item	l x w x h in cm	PU
5428.04	23.5x6.2x3	6 pcs



The mini fork "Europa" item 0405.1288 is available on page 240.



items 5428.04 + 5408.01 (page 230)





Suitable cruet stands are available from page 260 onwards.



glass bottle

square, suitable cork items 5297.01 and 5297.02 (please order separately)

item	l x w x h in cm	content in l	PU
5296.01	3.9x3.9x8.5	0.04	12 pcs
5296.02	4.9x4.9x11	0.1	12 pcs



cork

plastic, ecru, for glass bottle items 5296.01 and 5296.02

item	Ø in mm	height in mm	PU
5297.01	20/10	22	24 pcs
5297.02	26/15	28	24 pcs



glass bottle

square, with swing top (plastic and stainless steel), height incl. swing top

item	l x w x h in cm	content in l	PU
5295.01	5.4x5.4x12.5	0.1	12 pcs
5295.02	6.7x6.7x14.5	0.2	12 pcs

Its honed sides prevent the glass stopper from falling off when pouring from the closed bottle.



glass bottle/creamer

square, with glass stopper (round), with notched stopper for pouring with closed lid, height incl. stopper

item	l x w x h in cm	content in l	PU
5740	5x5x12.5	0.12	3 pcs



glass bottle

with swing top (PVC lid), height incl. swing top

item	Ø / height in cm	content in l	PU
5290.01	4.5 / 14.5	0.1	12 pcs
5290.02	5.5 / 19	0.2	12 pcs



DESIGN
by
ZEHER



miniature glass

round, with catch (galvanised steel) and silicone ring

item	Ø / height in cm	content in l	PU
5270	4.5 / 8.5	0.07	12 pcs



glass

round, with catch (galvanised steel) and silicone ring

item	Ø / height in cm	content in l	PU
5276	7 / 11.5	0.25	12 pcs.

Buffet platters/dinner plates made of white glass are available on page 59.



jam/sugar bowl

glass, transparent, round, lid with notch for spoon

item	Ø / height in cm	content in l	PU
5425	9.8 / 7.5	approx. 0.18	6 pcs

The creamer is handmade, deviations from the declared measurements may occur.



small jug

glass, transparent, handblown

item	Ø / height in cm	content in l	PU
5416	4.7 / 9.8	approx. 0.1	6 pcs



small butter & lard pot

glass, transparent, round

item	Ø in cm	height in cm	PU
5424	9	9.5	6 pcs



miniature glass bottle

glass, round, with glass lid (round), with notched stopper for pouring with closed lid, height incl. lid

item	Ø in cm	height in cm	content in l
5741	4.3	5.5	approx. 0.03



The stand "TriBo" item 2025.26 is available on page 119.

The glass plates are available on page 176, the glass cloche item 4982.09 on page 191.





The salad servers "Mao" are available on page 298.



The melamine tray item 4590 is available on page 124.



The black saucer made of china is available on page 162.



ashtray for cigars

optical glass, transparent, also usable as a rest for tongs or spoons, in black gift box

item	l x w x h in cm
5210	15x9x3



The jam trays made of polished stainless steel are available on page 272.



glass miniature

transparent, for jam tray items 2191... and jam tray item 5428.04

item	Ø / height in cm	content in l	PU
5408.01	4.6 / 6.8	0.05	6 pcs
5408.02	4.6 / 9.3	0.09	6 pcs



glass

item	Ø / height in cm	content in l	PU
5380	7.5 / 10.5	0.32	6 pcs
5381	7.5 / 6	0.18	6 pcs



glass

transparent, for bridges "Modul" items 4584 and 4724

item	Ø / height in cm	content in l	PU
5405	5 / 8.6	0.1	6 pcs



glass

transparent, reinforced foot (ring Ø 4.6 cm), for bridges "Modul" items 4584 and 4724

item	height in cm	content in l	PU
5413	9.5	0.07	12 pcs



More sizes of the glass bowls are available on page 179, the sushi platter on page 180.



small bowl

glass, 2 layers, handmade, heavy quality, Ø 7 cm, 4.5 cm high, approx. 0.08 l content, for sushi platter item 8035

item	version	PU
4859.07	white	6 pcs
4860.07	black	6 pcs



small bowl/cloche

glass, transparent, handblown, for ring "SelectionA." items 4681... (please order separately)

item	Ø / height in cm	content in l	PU
5418	9 / 6	0.2	6 pcs

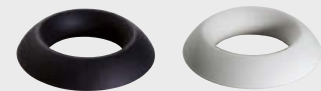

ring "SelectionA."

silicone, for the anti-slip placement of small bowl item 5418, Ø 8.3 cm

item	colour	PU
4681.S	black	6 pcs
4681.W	white	6 pcs



small bowl

borosilicate glass, handblown, round

item	Ø / height in cm	content in l	PU
4930	7 / 5	approx. 0.14	24 pcs



glass lid

transparent, for glass bowl item 5308.11

item	l x w in cm	PU
5308.11D	11x11	24 pcs



glass bowl

transparent, square

item	l x w x h in cm	content in l	PU
5308.08	8x8x4.5	0.14	6 pcs
5308.11	11x11x6	0.3	6 pcs



More sizes of the glass bowl are available on page 185.



glass bowl

transparent, oval

item	Ø / height in cm	content in l	PU
5330.08	7.5 / 3.5	0.08	6 pcs



glass platter

transparent, oval

item	l x w x h in cm	PU
5331.30	30x9.5x2	2 pcs



dessert glass

transparent, for bridges "Modul" items 4584 and 4724

item	Ø / height in cm	content in l	PU
5257	7 / 10	0.08	12 pcs



glass cone

transparent, for cone stand items 2194...

item	Ø / height in cm	content in l	PU
5415	3.5 / 8	0.03	12 pcs



3x items 5330.08 on item 5331.30



The food display is available on page 268.

items 4081.12 + 4593 (page 274)



items 5444 + 5143 (page 276)



bowl

white china, oval

item	l x w x h in cm	content in l	PU
4081.12	12.5x7.5x4	0.1	12 pcs



items 5444 + 4593 (page 274)



bowl

glass, transparent, oval

item	l x w x h in cm	content in l	PU
5444	12.5x7x4	0.08	6 pcs



bowl "Duo"

white china

item	l x w x h in cm	content in l	PU
4231.SO	13x7x3.5	0.08	12 pcs



items 4231.SO + 5145 (page 276)



bowl "Duo"

glass, transparent

item	l x w x h in cm	content in l	PU
5441	11.5x7x3.5	0.07	6 pcs



miniature bowl "Spobo" with spoon rest

white china, for spoons with a total length of 12 cm and over

item	Ø / height in cm	content in l	PU
4230.11	10.5 / 3.9	0.07	12 pcs



items 5440 + 5145 (page 276)



miniature bowl "Spobo" with spoon rest

glass, transparent, for spoons with a total length of 12 cm and over

item	Ø / height in cm	content in l	PU
5440	10 / 4	0.08	6 pcs



small bowl

white china, deep, oval

item	l x w x h in cm	content in l	PU
4326.11	11x9x3.8	0.1	12 pcs



glass miniature

glass, transparent, deep, oval

item	l x w x h in cm	content in l	PU
5442	11x9x3.8	0.09	6 pcs



miniature plate

white china, flat, oval

item	l x w x h in cm	PU
4324.11	11x9x1.8	12 pcs

glass miniature

glass, transparent, flat, oval

item	l x w x h in cm	PU
5443	11x9x1.7	6 pcs





The stainless steel cruet stand is available on page 266.



creamer
white china, stackable

item	Ø / height in cm	content in l	PU
4489	5.3 / 9	0.13	6 pcs



miniature

china, stackable, Ø 5.3 cm, 7 cm high, 0.1 l content

item	colour	PU
4490	white	6 pcs
4490.01	black	6 pcs



The vinegar/oil bottle is available on page 279, the cruet stand on page 265.



small bowl "Catering"

white china

item	Ø / height in cm	content in l	PU
4499	8 / 5.5	0.2	6 pcs
4500	8 / 2.5	0.08	12 pcs



The stainless steel cruet stand is available on page 267.



small bowl

white china

item	Ø / height in cm	content in l	PU
4498	8 / 6	0.17	6 pcs



egg cup "Catering"

white china

item	Ø in cm	height in cm
3977	5	5



tapas bowl "Catering"

white china

item	Ø / height in cm	content in l	PU
3962.06	6 / 3	0.03	24 pcs

The suitable etageres are available on pages 270 and 271.



NEW

miniature plate

stoneware, round, flat, Ø 10.5 cm

item	colour	PU
4606.10	white, glossy/matt underside	12 pcs
4607.10	black, matt	12 pcs



NEW

plate

stoneware, round, flat, Ø 17 cm

item	colour	PU
4606.17	white, glossy/matt underside	4 pcs
4607.17	black, matt	4 pcs

Cloches made of glass are available on pages 190 to 193.



saucer

biscuit china, white, inner circle glazed (Ø 9.5 cm), for round items with an inner diameter of 10.5 cm

item	Ø in cm	height in cm	PU
4398	11.5	1.3	6 pcs



miniature plate "Catering"

white china, flat, coup form

item	Ø in cm	PU
3954.08	8	12 pcs



Suitable cloches are available on page 191.



saucer

china, black, matt, round, with round deepening (Ø 9.3 cm)

item	Ø in cm	height in cm	PU
3857	13.5	1.5	6 pcs



porcelain pillow "Donna"
white

item	L x B x H in cm	PU
4461.03	12.3x8x2.7	12 pcs
4461.01	16.5x11x3.5	6 pcs

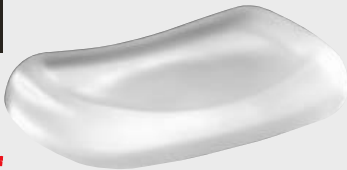

New!
glass pillow "Donna"
glass, satined, in black gift box

item	L x W x H in cm
5446.01PB	16.5x11x3



plateau plate "DressCoat"
white china, useable area (plateau): Ø 7.5 cm, also useable as a bowl

item	Ø / height in cm	content in l	PU
4386.01	9 / 4.5	0.1	12 pcs



dip bowl "Twist" for olive oil
white china

item	L x W x H in cm	PU
3912	12x12x1.8	6 pcs



plateau plate "DressCoat"
white china, useable area (plateau, glazed): Ø 6.5 cm, also useable as a bowl: 0.09 l content, Ø 8 cm, 4 cm high

item	outside	PU
4386.02B	unglazed	12 pcs
4386.02	glazed	12 pcs



The complete series "Pueblo" is available on pages 152 and 153.



miniature "Pueblo"
stoneware, outside white (matt finish), inside white (glossy), round, organically shaped

item	Ø / height in cm	content in l	PU
4604.01	6.5 / 5.2	0.09	6 pcs
4604.02	6.5 / 7.2	0.15	6 pcs

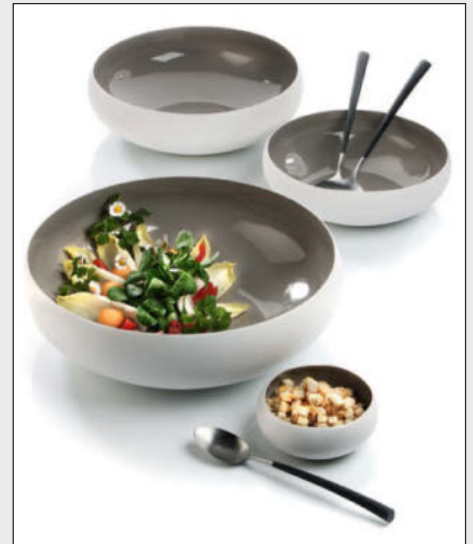

More bowls of the series "Pueblo" are available on page 152.



bowl "Pueblo"
stoneware, outside white (matt finish), round, organically shaped, Ø 12 cm, 4.5 cm high, 0.3 l content

item	colour inside	PU
4602.12	glossy white	4 pcs
4603.12	glossy taupe	4 pcs

"Cave"

Like the shell hides the pearl, the porcelain bowl "Cave" conceals precious delicacies within its hard shell. At first sight this porcelain piece only partly reveals its interior. "Cave" consists of intricately worked hard porcelain and captures by its soft shape and the velvety haptics of the unglazed outside. Touching the cave-shaped bowl it feels almost like a palm stone made of white gold, having a soft appearance with delicious contents. "Cave" is predestined for a use at cocktail and hors d'oeuvres receptions or at the flying buffet. The miniature bowl can be carried comfortably and fits perfectly in the palm of the hand.



New!



bowl "Cave"

biscuit china, white, inside glazed, opening:
Ø approx. 8 cm, in black gift box

item	Ø in cm	height in cm	PU
4375.01PB	approx. 11	7	1 pc.



Design: Wilma Greim



miniature platter

white china

item	l x w in cm	PU
4072.M	13x6	12 pcs



small bowl

white china, for gravy, sauce and side dishes

item	l x w x h in cm	content in l	PU
4082	7x7x2.8	0.06	12 pcs



amuse gueule bowl

white china, with handle

item	length in cm	content in l	PU
4102	8	0.02	12 pcs

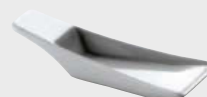

amuse gueule/tapas spoon "Modul"

white china

item	l x w x h in cm	PU
4260.03	10x4x2.2	12 pcs



small sauce boat

white china, for single portions, with spout

item	l x w x h in cm	content in l	PU
4093	8.2x5.8x4.2	0.07	12 pcs



miniature plate

white china, flat

item	l x w in cm	PU
4240.10	10x10	12 pcs



amuse gueule/tapas spoon

white china

item	l x w x h in cm	PU
4260.01	13x4x3	12 pcs

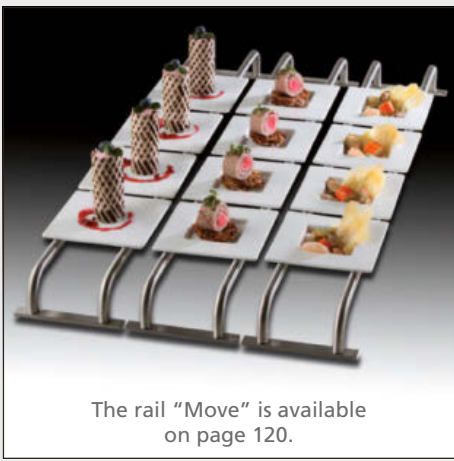

The rail "Move" is available on page 120.



platter "Move"

white china, with foot (6.8 cm x 6.8 cm), useable as plate for rail "Move" item 2023

item	l x w x h in cm	PU
4463	12x12x1	6 pcs



small bowl "Move"

white china, flat, with foot (6.8 cm x 6.8 cm), useable as small bowl for rail "Move" item 2023

item	l x w x h in cm	PU
4464	12x12x1.4	6 pcs



small bowl "Move"

white china, deep, with foot (6.8 cm x 6.8 cm), useable as small bowl for rail "Move" item 2023

item	l x w x h in cm	PU
4465	12x12x3	6 pcs



plate "Modul"

white china, square, flat, for base trays "Modul" made of walnut and melamine

item	l x w in cm	PU
4380	11x11	12 pcs



bowl "Modul"

white china, square, deep, for base trays "Modul" made of walnut and melamine

item	l x w in cm	content in l	PU
4381	11x11	0.07	12 pcs



plate "Modul"

white china, flat, lengthwise, for base trays "Modul" made of walnut and melamine

item	l x w in cm	PU
4383	22x11	12 pcs



bowl "Modul"

white china, deep, lengthwise, for base trays "Modul" made of walnut and melamine

item	l x w in cm	content in l	PU
4384	22x11	0.22	12 pcs



glass plate "Modul"

transparent, flat, lengthwise, for base trays "Modul" made of walnut and melamine

item	l x w in cm	PU
5074.01	22.5x11	6 pcs



glass plate "Modul"

frosted look, flat, lengthwise, for base trays "Modul" made of walnut and melamine

item	l x w in cm	PU
5074.02	22.5x11	6 pcs



glass plate "Modul"

deep black, flat, lengthwise, for base trays "Modul" made of walnut and melamine

item	l x w in cm	PU
5074.03	22.5x11	6 pcs





The series "Reef" is available on pages 66 and 67.



New!



honey spoon "Cuspis"

borosilicate glass, transparent/white, handblown, star-shaped, please note the safety instructions on each pack

item	length in cm	PU
4942.01	16	4 pcs

small bowl

glass, square, flat

item	l x w x h in cm	PU
5113.01	8.5x8.5x1.5	12 pcs



small bowl

glass, dark grey, organically shaped, 6 mm thick, for bowl/basket "Reef" item 2310 (page 66, please order separately)

item	Ø / height in cm	content in l	PU
5166	13 / 6.5	approx. 0.3	2 pcs



New!



small tray/glass coaster

glass, deep black, rectangular

item	l x w x h in cm	PU
5167	11.5x5.5x1.5	12 pcs

small bowl

glass, rectangular, flat

item	l x w x h in cm	PU
5099	11.5x5.5x1.5	12 pcs



New!



honey spoon with glass tray "Cuspis"

set consists of:

honey spoon made of borosilicate glass, transparent/white, handblown, star-shaped
tray made of glass, deep black, rectangular
1 set in black gift box

item	l x w x h in cm	length (spoon) in cm	PU
4944.PB	11.5x5.5x1.5	16	1 set (2 parts) 📦

miniature plate

glass, transparent, flat

item	l x w in cm	PU
5034	10x10	12 pcs



miniature plate

glass, deep black, flat

item	l x w in cm	PU
5034.01	10x10	12 pcs

small bowl "Drop"

glass, transparent

item	l x w in cm	PU
5039	10x8.5	12 pcs



The cloches are available on page 190.



small bowl "Drop"

glass, longitudinal grooves

item	l x w in cm	PU
5040	10x8.5	12 pcs

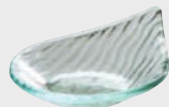

small bowl "Drop"

glass, deep black

item	l x w in cm	PU
5039.01	10x8.5	12 pcs

More items of the series "Artisan" are available on pages 78 and 79.



bowl "Artisan"

stainless steel 18/10, round, inside polished, outside matt finish, hammered rim with golden adornment (brass)

item	Ø in cm	height in cm	content in l
2371.07	7.5	3.5	approx. 0.1
2371.11	11	5.5	approx. 0.3



bowl

massive stainless steel 18/10, triangular, hammered finish, six times polished

item	Ø in cm	height in cm	content in l
a)2180.09	9	4	0.08
b)2180.13	13	6	0.28



bread/pastry dish

massive stainless steel 18/10, hammered finish, six times polished

item	l x w x h in cm
2133.12	12x7.5x4.5



bowl

massive stainless steel 18/10, oval, hammered finish, six times polished, 9 cm long, 6 cm wide, 0.10 l content

item	version
2149.07	without spiral clip
2155.01	with spiral clip



bowl

massive stainless steel 18/10, round, hammered finish, six times polished, Ø 7.5 cm, 0.11 l content

item	Ø in cm
2153	without spiral clip
2155	with spiral clip



jam tray

stainless steel 18/10, polished, for e.g. "Darbo" portion jam (28 g and 40 g), portion ketchup or mustard

item	version	l x w in cm
2191.03	3 holes (Ø 4.5 cm)	19.5x7.5
2191.04	4 holes (Ø 4.5 cm)	24x7.5



The suitable glasses items 5408... are available on page 230.



etagere

massive stainless steel 18/10, triangular, smooth finish, six times polished, not demountable

item	Ø in cm	height in cm
2187	13	16.5



bowl

massive stainless steel 18/10, triangular, smooth finish, six times polished

item	Ø in cm	height in cm	content in l
2182.09	9	4	0.08
2182.13	13	6	0.28



bowl

massive stainless steel 18/10, round, smooth finish, six times polished

item	Ø in cm	content in l
2153.01	7.5	0.11



bowl

massive stainless steel 18/10, oval, smooth finish, six times polished

item	l x w x h in cm	content in l
2159.16	16x10x3.5/7	approx. 0.2
2159.20	20x12x5/9	approx. 0.35

bowl

in black gift box

item	l x w x h in cm	content in l
2159.16PB	16x10x3.5/7	approx. 0.2
2159.20PB	20x12x5/9	approx. 0.35

More sizes of the bowls are available on page 85.

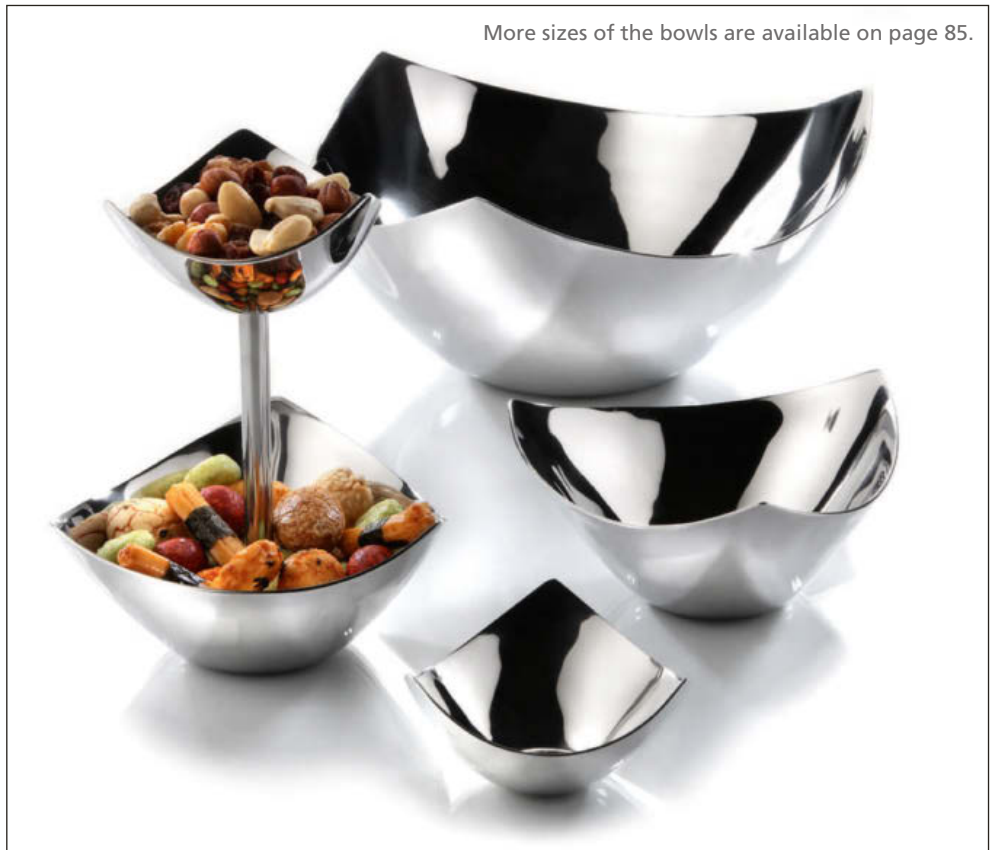

The glass tray with the small bowls made of china is available on page 277, the nut bowl on page 220.





espresso spoon "Goa"

stainless steel 18/10, with black handle of resin, dishwasher-safe

item	length in cm	PU
0492.09	10	12 pcs



espresso spoon "Mao"

stainless steel 18/10, with black handle of resin, dishwasher-safe

item	length in cm	PU
0493.09	10.5	12 pcs



miniature fork "Europa"

stainless steel 18/10, polished, excellent product quality, exceptional stability and durability, 3 mm thick

item	length in cm	PU
0405.1288	11.5	12 pcs
0405.1388	16	12 pcs



small skewer

stainless steel 18/0, matt, 9.5 cm long

item	version	PU
1939.03	moon	24 pcs
1939.04	flame	24 pcs

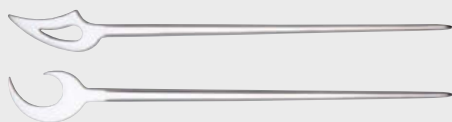

skewer

stainless steel 18/10, 24 cm long

item	version	PU
1939.01	moon	12 pcs
1939.02	flame	12 pcs



amuse gueule/tapas spoon "Modul"

white china

item	l x w x h in cm	PU
4260.03	10x4x2.2	12 pcs



amuse gueule/tapas spoon

white china

item	l x w x h in cm	PU
4260.01	13x4x3	12 pcs



espresso spoon "Spade"

stainless steel 18/10, polished, with hanger, 1.2 mm thick

item	length in cm	PU
1936	9	12 pcs



The buffet platter "Shabby Chic" is available on page 55.



glass spoon "Cuspis"

borosilicate glass, transparent, handblown, with star-shaped ball handle

item	l x w x h in cm	PU
4941.01	approx. 7x4x3.5	6 pcs



Suitable spoon rests made of walnut and melamine are available on pages 132 and 134.

hammered

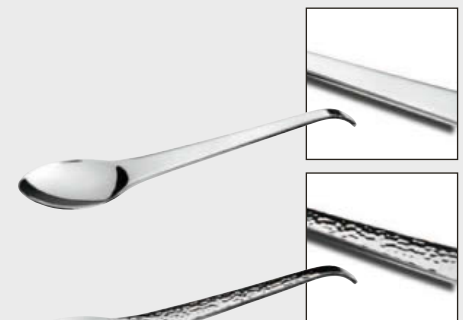

party spoon

stainless steel 18/10, heavy quality, 4.3 mm thick, 21 cm long

item	version
1938	polished
1938.01	hammered finish



honey spoon "Cuspis"

borosilicate glass, transparent/white, handblown, star-shaped, please note the safety instructions on each pack

item	length in cm	PU
4942.01	16	4 pcs



marble mortar

black/brown, outside polished, with pestle

item	Ø in cm	height in cm
8037	9.5	5
8038	20	12



bowl

granite, anthracite, fully polished

item	Ø in cm	height in cm
8034	18	7



Skewers and more!

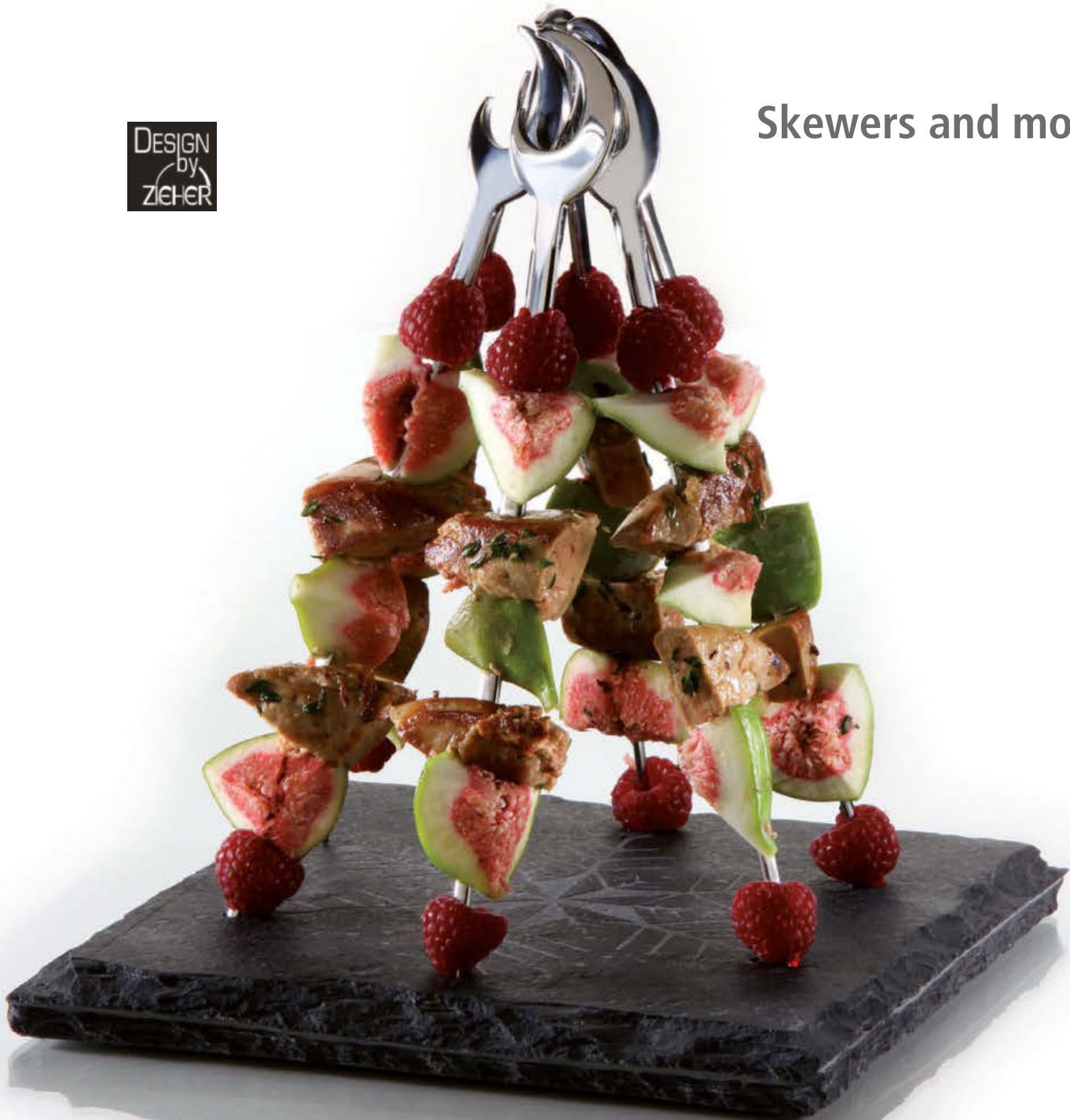



Slate is a unique and exceptional natural product. The surfaces of our slate plates have the typical slaty cleavages, therefore every piece is unique. Small deviations in structure, thickness and weight of the plates cannot be avoided because of the nature of the product. There may be single inclusions of other minerals and fossils. These extraordinary features give slate its precious and vivid appearance. Please note: Specific groceries, especially those that contain fruit acid (citric acid), may damage the surface in case of longer contact. Therefore we recommend avoiding direct contact with edibles.

Marble is a natural product, which means that the dark brown marbling can vary strongly. This is exactly what creates the vivid and unique look of this natural stone. Please note: Specific groceries, especially those that contain fruit acid (citric acid), may damage the surface in case of longer contact. Therefore we recommend avoiding direct contact with edibles.

Cleaning: Please clean only with a wet cloth and gentle cleaners. Not dishwasher-safe. Cleaning in a dishwasher may dull the surface.

Granite is a natural product. Deviations in colour or structure are possible. Infrequently, pockets in the stone may occur. Granite is the hardest and most impervious kind of our natural stones!

Sushi trays made of granite are available on page 180, a bowl on page 241.

The small bowls "Amuse" are available on page 216.



skewer plate

slate, with star motif, not sealed, for 6 skewers
items 1939.01 and 1939.02 (please order separately)

item	l x w x h in cm	PU
8042	20x20x1.5	3 pcs



marble platter

black/brown, rectangular, polished surface, sides rough-textured, 2.5 cm thick, feet of felt, not dishwasher-safe, for holder coil shape items 2167... (page 98) or skewer items 1939.01/02 (please order separately)

item	version	l x w in cm
8022.01	2 holes	20x10
8022.02	3 holes	30x10



skewer

stainless steel 18/10, 24 cm long

item	version	PU
1939.01	moon	12 pcs
1939.02	flame	12 pcs



slate plate

natural slate, rectangular, not sealed, with 4 feet of felt (not dishwasher-safe)

item	l x w in cm	thickness in cm	PU
8046	29.5x5	approx. 1.0	3 pcs



slate plate

natural slate, not sealed

item	l x w in cm	thickness in cm	PU
8045	10x10	approx. 0.5	6 pcs



slate plate

natural slate, rectangular, not sealed

item	l x w in cm	thickness in cm	PU
8047	19.7x7.8	approx. 0.5	6 pcs



*Drilled holes Ø 3 mm:
suitable for small skewers items
1939.03/04 or retail skewers made of wood

skewer plate

natural slate, rectangular, double, with 35 holes (Ø 3 mm*), not sealed, with 6 feet of felt (not dishwasher-safe)

item	l x w x h in cm
8051	35x25x2.6



skewer plate

natural slate, rectangular, double, with 6 holes (Ø 3 mm*), not sealed, with 4 feet of felt (not dishwasher-safe)

item	l x w x h in cm	PU
8050	25x5.5x2.6	4 pcs



skewer plate

natural slate, rectangular, with 4 holes (Ø 3 mm*), not sealed, with 4 feet of felt (not dishwasher-safe)

item	l x w x h in cm	PU
8048	17x4x2	6 pcs



skewer plate

natural slate, rectangular, with 12 holes (Ø 3 mm*), not sealed, with 4 feet of felt (not dishwasher-safe)

item	l x w x h in cm	PU
8049	27x7x2	4 pcs



small skewer

stainless steel 18/0, matt, 9.5 cm long

item	version	PU
1939.03	moon	24 pcs
1939.04	flame	24 pcs

"Solid"

1 + 2 + 3



1 + 2 + 5



Delicacies in delicate setting – presentation boxes made by Zieher!

Due to the comprehensive range of accessories the small-sized box offers multiple application possibilities. The box, regularly fitted with a wooden sliding lid, can be equipped with several optionally available inserts made of top-quality solid surface material. The also available lid made of brown-tinted glass puts the presented goods in the limelight. Apart from an insert with round cavities for nine truffles/chocolates and a flat plate that can be used for layered chocolates, various little somethings or amuse bouches, there is also an insert available for commercial coffee capsules.

1 + 2 + 4



1 + 2 + 5



The insert for cigars can hold up to four cigars and a separate compartment aside offers additional space for matches, cigar cutters, etc. No matter if it is an assortment of coffee specialities or various delicacies of the pâtisserie, the presentation box by Zieher provides the perfect setting for many purposes.



1 storage/presentation box "Solid"
walnut, food-safe sealed, not dishwasher-safe, with sliding lid made of wood, also available with glass lid item 4762.18G (please order separately)

item	l x w x h in cm	size inside in cm
4762.18	18x18x6	approx. 16x16x4.2



2 glass lid
brown tinted, with recess, for storage/presentation box "Solid" item 4762.18

item	l x w in cm
4762.18G	17.3x16.7

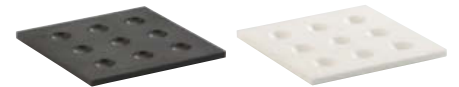

3 insert for chocolates
solid surface material, with 9 cavities (Ø 2.2 cm), for storage/presentation box "Solid" item 4762.18

item	version	l x w x h in cm
4763.01S	black	15.8x15.8x1
4763.01W	white	15.8x15.8x1

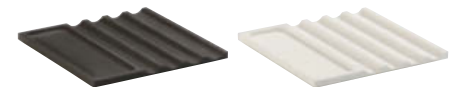

4 insert for cigars
solid surface material, for 4 cigars (grooves 1.9 cm wide), storage area for accessories (14.8 cm x 4.8 cm), for storage/presentation box "Solid" item 4762.18

item	version	l x w x h in cm
4763.02S	black	15.8x15.8x1
4763.02W	white	15.8x15.8x1

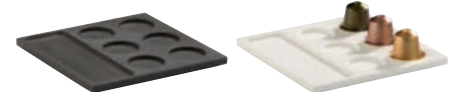

5 insert for coffee capsules
solid surface material, with 6 cavities (Ø 3.8 cm), storage area for accessories (14.8 cm x 4.8 cm), for storage/presentation box "Solid" item 4762.18

item	version	l x w x h in cm
4763.03S	black	15.8x15.8x1
4763.03W	white	15.8x15.8x1



6 insert/platter
solid surface material, white, usable area: 14.8 cm x 14.8 cm, for storage/presentation box "Solid" item 4762.18

item	l x w x h in cm
4763.04W	15.8x15.8x1



More sizes of the storage/presentation box "Solid" are available on page 288.

Cruet stands, trays and more!





Marco D'Andrea:

"In search of the perfect way to present my chocolates/truffles and after receiving manifold inspiration from colleagues, I have asked a carpenter of my acquaintances to manufacture some first prototypes. It was important to me that the box could be used to present jewellery and diamonds as well.

In addition to our petit fours trolley we used the prototypes in our gourmet restaurant; in our restaurant "Deck 7" we sell the chocolates/truffles along with the coffee. The round deepenings in the box are made out specifically that, even if the box is inclined, the truffles will not roll out. Chocolates/truffles with a diameter ranging from 22 to 28 mm fit easily into the deepenings. The dark wood of the walnut tree gives the box a fine and modern look. The brown tinted glass yields the secrets hidden inside the box only once it is given a very close look. The glass can be inserted vertically into the back part of the box or can be slid in under the box. Once closed, anything inside the box can be stored hygienically. The narrow, sidelong compartment in each box can be used individually. Besides placing a tong or other serving cutlery, it can also be used for the presentation of more chocolates or petit fours."



chocolate/truffle box "Solid"

walnut, with brown-tinted glass lid (can be used as rear wall or to slide in on the bottom side), food-safe sealed, rectangular, not dishwasher-safe, 2 compartments: 1st compartment with 48 cavities for chocolates, 2nd compartment 21.3 cm x 6 cm

item	l x w x h in cm
4738	36.8x23.8x6

chocolate/truffle box "Solid"

walnut, with brown-tinted glass lid (can be used as rear wall or to slide in on the bottom side), food-safe sealed, square, not dishwasher-safe, 2 compartments: 1st compartment with 24 cavities for chocolates, 2nd compartment 21.3 cm x 6 cm

item	l x w x h in cm
4737	23.8x23.8x6

chocolate/ice cube tongs

massive stainless steel 18/10, hammered finish, six times polished, 19 cm long

item	version
2138	stainless steel
2138.G	stainless steel, golden
2138.C	stainless steel, copper

The most exquisite chocolates/truffles in exclusive ambiance

Finest creations of the pâtisserie have to be presented in a worthy frame!

A presentation box with exchangeable inserts made of composite mineral is available on page 244.

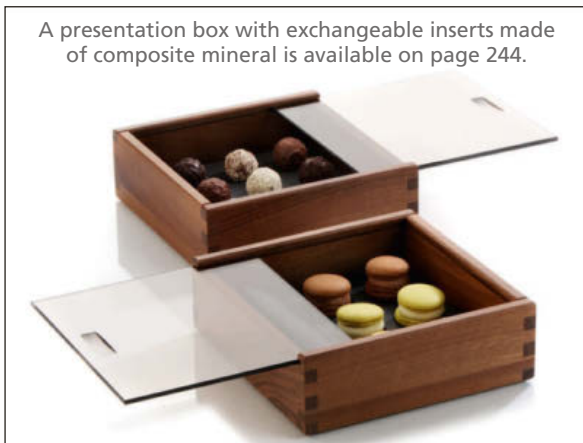

Idea and design for these presentation boxes “Solid” for truffles and filled chocolates are from Marco D’Andrea, pâtissier and “Junger Wilder 2012”. With this most coveted award Marco D’Andrea has been acknowledged for his creative work.

In the year 2014 D’Andrea has been proclaimed “Pâtissier of the year 2014” during the “Leaders of the Year” convention (powered by ROLLING PIN).

Marco D’Andrea has visited the Zieher booth at the Salzburg fair after he won the challenge of “Die jungen Wilden 2012”, to present his filled chocolates and truffles in Zieher products. He happened to have with him the prototypes of his chocolate/truffle boxes, and everyone at the stand immediately realized that these boxes would fit perfectly into the Zieher portfolio. After some small improvements in construction and quality, the first Zieher boxes had been presented in 2013 already. The wood of the walnut tree has been chosen for this box, as it had been for the “Solid” series already.



Please note: the maximum filling height of the side compartment is 26 mm (when lid is closed).

"Solid" - Wood in its most beautiful shape!

Wood from the European walnut tree, which is one of the most precious and most beautiful types of wood, forms the basis for this series. Both the wood's warm brown colours in different shades and its intensive and distinctive grain make every product a unique item. The high-quality workmanship in combination with the food-safe sealing guarantees long durability, even in daily use. Please note the enclosed care instructions, not dishwasher-safe, do not immerse in water!



The bread buffet "Solid" is available on pages 106 to 111.



The glass plates are available on page 176.



cutlery/napkin box "Solid"

walnut, food-safe sealed, not dishwasher-safe, with rubber feet in the lid (soft closure, can be opened to an angle of 90°) and at the bottom, with black felt insert, stainless steel platter with space for an engraving (price and quantity upon request), 15.5 cm height with opened lid

item	l x w x h in cm	size inside in cm
4766	28.8x11.8x6	26x9

DESIGN
by
ZEHER



cutlery box "Solid"

walnut, with acrylic glass lid, food-safe sealed, not dishwasher-safe, with 4 rubber feet, for cutlery with a length of up to 24.3 cm

item	l x w x h in cm
4720	26.5x16.2x8





box "Solid"

walnut, food-safe sealed, not dishwasher-safe, 2 compartments: 10.4 cm x 5.2 cm and 10.4 cm x 16.6 cm, with 4 rubber feet, for china/glass bowls (4.9 cm long and 4.9 cm wide)

item	l x w x h in cm
4703	24.4x12.4x4



box "Solid"

walnut, food-safe sealed, not dishwasher-safe, 2 compartments: 14.4 cm x 7.2 cm and 14.4 cm x 14.6 cm, with 4 rubber feet, for china/glass bowls (7 cm long and 7 cm wide)

item	l x w x h in cm
4704	24.4x16.4x4



box "Solid"

walnut, food-safe sealed, not dishwasher-safe, with 4 rubber feet

item	l x w x h in cm	l x w (inside) in cm
4705	24.4x16.4x4	22.4x14.4



box "Solid"

walnut, food-safe sealed, not dishwasher-safe, 3 compartments: 2x 10.4 cm x 5.2 cm and 1x 10.4 cm x 16.6 cm, with 4 rubber feet, for china/glass bowls (4.9 cm long and 4.9 cm wide)

item	l x w x h in cm
4712	30.2x12.4x4



tray "Solid"

walnut, food-safe sealed, not dishwasher-safe, with 4 rubber feet, for china/glass bowls (4.9 cm long and 4.9 cm wide)

item	l x w x h in cm
4719	15.2x15.2x2.5



tray "Solid"

walnut, food-safe sealed, not dishwasher-safe, with 4 rubber feet, for china/glass bowls (7 cm long and 7 cm wide)

item	l x w x h in cm
4719.01	19.5x19.5x2.5



Suitable inserts made of glass and china are available on pages 263 and 264.



tray "Solid"

walnut, food-safe sealed, not dishwasher-safe, delivery without glass insert items 4701.G, 4702.G, 4708.G and 4709.G (please order separately)

item	l x w x h in cm	l x w (inside) in cm
4701	24x12x2	19x7
4702	36x18x2	31x13
4708	25.8x10.2x2	20.8x5.2
4709	32.5x32.5x2	28.1x28.1

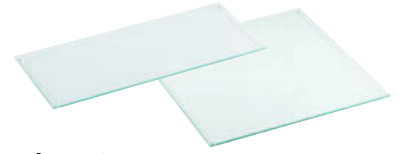

glass insert/saucer

transparent, incl. 4 transparent rubber feet, suitable for tray "Solid" items 4701, 4702, 4708 and 4709

item	l x w x h in cm	PU
4701.G	18.9x6.9x0.4	2 pcs
4702.G	30.9x12.9x0.4	2 pcs
4708.G	20.7x5.1x0.4	2 pcs
4709.G	28x28x0.4	2 pcs



items 4710 + 1669.33

-serving tray "Solid"

walnut, food-safe sealed, not dishwasher-safe, round, stackable, with corrugated pattern outside

item	Ø in cm	height in cm
4710	36	4



dinner plate/glass insert

for serving tray "Solid" item 4710, special hardened safety glass, edge polished, dishwasher-safe, rubber feet included (adhesive), underside scratch-proof, 4 mm thick, Ø 33 cm

item	version
1669.33	black glass
1671.33	white glass



dinner plate/glass insert

for serving tray "Solid" item 4710, hardened glass, edge polished and deburred, 6 mm thick

item	Ø in cm
4999	33



bowl "Solid"

walnut, food-safe sealed, not dishwasher-safe, round, stackable, with corrugated pattern outside

item	Ø in cm	height in cm
4711.18	18	6
4711.24	24	8
4711.30	30	10



The boxes made of walnut and more items for the hotel room are available on pages 284 to 296.





bread basket "Solid"

maple, boat-shaped, food-safe sealed, not dishwasher-safe

item	l x w x h in cm
4771.24	24.5x12x5



bread basket "Solid"

walnut, boat-shaped, food-safe sealed, not dishwasher-safe

item	l x w x h in cm
4770.24	24.5x12x5

The tealight holders "Solid" are available on page 280.



bread basket "Solid"

walnut, oblique, food-safe sealed, not dishwasher-safe

item	Ø in cm	height in cm
4760	13	10.5
4761	14	9



The bread baskets made of solid maple and walnut wood surprise with their exceptional design and their highly sophisticated handcraft.



Designing these bowls, the Milanese designer Itamar Harari did not only think of the serving of bread but also of the typical Italian Grissini. Recesses at both ends are especially suitable for those. A selection of fruit in the hotel room also receives much attention if stylishly presented in these extraordinary bowls made of beautiful wood.



Design: Itamar Harari





glass cloche

borosilicate glass, transparent, handblown, handmade, for saucer "Solid" items 4700...

item	Ø in cm	approx. height in cm
4982.09	9	14-16
4982.11	11	17-19
4982	13	20-23



glass insert "Solid"

hardened glass, transparent, with 4 transparent silicone feet, edge polished and deburred, 4 mm thick, glass inlay for saucer "Solid" items 4700...

item	Ø in cm	PU
5244.09	9	6 pcs
5244.11	11	6 pcs
5244	13	6 pcs

The cloches of the series "Amuse" and more cloches made of glass and china are available on pages 188 to 195.



saucer "Solid"

walnut, food-safe sealed, not dishwasher-safe, for glass cloche items 4982... and glass inlay items 5244...

item	Ø / height in cm	Ø inner circle in cm
4700.01	15.3 / 2	9.3
4700.02	18.7 / 2	11.3
4700	22 / 2	13.3



The wind lights made of transparent or satined glass are available on page 281.



GIFT BOX



cloche with wooden saucer and glass insert

set consists of:

cloche made of borosilicate glass

insert made of hardened transparent glass (4 mm thick)

saucer made of walnut

1 set in black gift box

item	Ø in cm	height in cm	PU
4882.22PB	27	approx. 37-40	1 set (3 parts)
4882.30PB	34.5	approx. 50-53	1 set (3 parts)



glass cloche

borosilicate glass, transparent, handblown, handmade, for saucer "Solid" items 4734...

item	Ø in cm	height in cm
4880.18	18.5	approx. 29-32
4880.22	22.5	approx. 35-38
4880.26	26	approx. 41-44
4880.30	30	approx. 48-51



glass insert "Solid"

hardened glass, transparent, with 4 transparent silicone feet, edge polished and deburred, 4 mm thick

item	Ø in cm	for saucer "Solid" item
5244.17	16.7	4734.01
5244.21	20.7	4734.02
5244.24	24.2	4734.03
5244.28	28.2	4734.04



saucer "Solid"

walnut, food-safe sealed, stackable, not dishwasher-safe, for glass cloche items 4850, 4851, 4852 and 4880... and glass inlay items 5244....

item	Ø / height in cm	for cloche / inlay
4734.01	23 / 3	Ø 18.5 / 16.7 cm
4734.02	27 / 3	Ø 22.5 / 20.7 cm
4734.03	30.5 / 3	Ø 26 / 24.2 cm
4734.04	34.5 / 3	Ø 30 / 28.2 cm

Please note the advice concerning the cloches on page 195.



Other kinds of wood upon request! (custom built)



glass cloche

glass, transparent, with round handle, handblown, for saucer "Solid" items 4734...

item	Ø in cm	height in cm
4850	18.5	31
4851	22.5	37
4852	26	43

Please note the care instructions for wooden items: not dishwasher-safe, do not immerse in water!

“Connect!”

Serving platters made of walnut!



Sublime in their appearance, unadorned in design, practical by compact formats and highly functional in combination - the solid wood boards of the series “Connect!” convince as a snack board, serving or cutting board, or as a presentation platter created by the combination of several elements.

“Connect!” is an extremely versatile tool for everyday use. The integrated tenon in the shape of a dovetail serves as a decorative handle with an artisanal touch. Suitable cutouts at the underside allow an easy combination of different elements. Skid-proof positioning feet ensure a firm stand, the slanted outer edges facilitate handling.



The solid walnut wood is sealed with high-quality oils which makes it easy to freshen up the surface from traces of everyday wear and tear.



New



cutting/snack board “Connect!”

walnut, oiled, pluggable, not dishwasher-safe, with handle, with 4 rubber feet, in black gift box

item	l x w x h in cm	l incl. handle
4774.31PB	26.5x20x2.3	31



New



cutting/snack board “Connect!”

walnut, oiled, pluggable, not dishwasher-safe, with handle, with 4 rubber feet, in black gift box

item	l x w x h in cm	l incl. handle
4775.44PB	40x16x2.3	44.5



Breakfast in bed - Inroom dining!



New!

bed tray „Solid“

walnut, with feet, food-safe sealed, not dishwasher-safe, stackable, with 2 handles, recessed on one side of the rim

item	l x w x h in cm closed	l x w x h in cm set up
4773.PB	60x40x6.5	approx. 74x40x31 

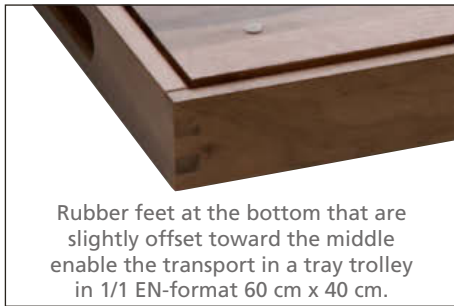

Rubber feet at the bottom that are slightly offset toward the middle enable the transport in a tray trolley in 1/1 EN-format 60 cm x 40 cm.



roomservice tray „Solid“

walnut, food-safe sealed, not dishwasher-safe, stackable, with 2 handles, with 4 rubber feet, recessed on one side of the rim, suitable for tray stand „Solid“ item 4748

item	l x w x h in cm
4735	60x40x5.4



The roomservice tray as well as the new bed tray stand out due to the precious walnut which is incorporated into these products with high-quality craftsmanship. The recessed longside enables comfortable dining directly off the tray. The retractable feet of the bed tray have been constructed in a very stable way and are securely kept in position by integrated magnets when folded in. The height of the erected tray has been chosen in a way that even with soft mattresses a comfortable seating beneath the tray is guaranteed. So start off the day with a boundlessly relaxing breakfast in bed!



A suitable tray stand made of walnut is available on page 286.



"Solid"



box/tray "Solid"

walnut, food-safe sealed, not dishwasher-safe, with 4 rubber feet

item	l x w x h in cm	l x w (inside) in cm
4713	34x34x3	32x32



serving tray "Solid"

walnut, food-safe sealed, with 2 handles, not dishwasher-safe, with 4 rubber feet, utility space: 44.5 cm x 30 cm

item	l x w x h in cm
4706	50x30x5



glass platter

special hardened safety glass, rectangular, rounded edges, polished rim, dishwasher-safe, rubber feet included (adhesive), underside scratch-proof, 4 mm thick, for serving trays "Solid" items 4707.PB and 4740

item	version	l x w in cm
1668.03	black glass	50x34
1670.03	white glass	50x34

serving tray "Solid"

walnut, deep, food-safe sealed, not dishwasher-safe, with 2 recessed grips, with 4 rubber feet

item	l x w x h in cm
4740	53x37x10

gift box

walnut, flat, food-safe sealed, not dishwasher-safe, with 2 recessed grips, with 4 rubber feet, in black gift box

item	l x w x h in cm	l x w (inside) in cm
4707.PB	53x37x4	50.2x34.2

Suitable displays and various accessories for the service tray items 4740 and 4707.PB are available on pages 106 to 109.





“Fakir”

brass, inside golden (transparent coating, food-safe), outside dark patinated, not dishwasher-safe

item	Ø in cm	height in cm
2380.07	7.5	11
2380.12	12.5	10
2380.15	15	8.5
2380.18	18	9.5



“Solid”

hardened glass, transparent, with 4 transparent silicone feet, edge polished and deburred, 4 mm thick

item	Ø in cm	PU
5244.09	9	6 pcs
5244.11	11	6 pcs
5244	13	6 pcs
5244.17	16.7	1 pc.
5244.21	20.7	1 pc.
5244.24	24.2	1 pc.
5244.28	28.2	1 pc.



Massive brass produced in traditional sand casting creates unique sculptural items, which enthuse especially by their contrast between matt golden surfaces and dark patination. A perfect add-on to the “Fakir” bowls are round glass platters of the Zieher product range. These can be laid on easily and generate thus the option to use the impressive objects on both sides.

Please note: the items made of brass are suitable for cold/dry food only. Not dishwasher-safe.



“Capiz”

shell, ivory-coloured, resin-coated, square, not dishwasher-safe

item	l x w x h in cm
7103.20	20x20x2
7103.26	26x26x2



“Capiz”

Ivory-coloured clamshells with a nacreous gloss grant these products their special appeal.

Genuine clamshells are grinded razor-thin and embedded in robust resin. This process protects and stabilizes the delicate clamshell-wafers in the long term. The transparent resin creates an impressive depth effect and a classy shine on every item of the “Capiz” series.

Please note: the items made of resin coated shells are suitable for cold/dry food only. Not dishwasher-safe.

"Slope"



tray "Slope"
melamine, matt, rectangular (oblique), stackable,
utility space: approx. 26 cm x 15.5 cm

item	colour	l x w x h in cm	PU
4595.30	black	30x19.5x4.2	3 pcs
4596.30	white	30x19.5x4.2	3 pcs



tray "Slope"
melamine, matt, rectangular (oblique), stackable,
utility space: approx. 40 cm x 24 cm

item	colour	l x w x h in cm	PU
4595.45	black	45x29x4.2	2 pcs
4596.45	white	45x29x4.2	2 pcs



tray "Slope"
in black gift box

item	colour	l x w x h in cm	PU
4595.45PB	black	45x29x4.2	1 pc.
4596.45PB	white	45x29x4.2	1 pc.

"Slope"

The melamine tray "Slope" is characterised by its unobtrusive shape and the pleasant feel of the matt and finely structured surface. An elevated corner and the resultant asymmetry awards the tray that certain something. Besides the obvious function as a service tray for espresso, cocktails, snacks and more it, also performs well in the hotel bathroom or as a decorative trivet in the hotel room. "Slope" is available in a black and a white version and in two sizes. The robust raw material melamine appears very elegant due to its matt surface and of course it complies with demands of everyday use like food safety, dishwasher resistance as well as stackability.



Cruet stands and trays ...



5+30+31+33

4+26+27



7+19+20+23



6+17+18

5+33



1 tray for inserts up to 5x5 cm

china, black, matt, with rim

item	l x w x h in cm	PU
4451	22x11.5x2.3	6 pcs



2 tray for inserts up to 7x7 cm

china, black, matt, square, with rim

item	l x w x h in cm	PU
4455	21x21x2.3	4 pcs



8+33+34



7+27

7+23+24

... made of stainless steel and china, ...



5+32+33



3+17+18

6+15+16



3 cruet stand for inserts up to 4x4 cm
stainless steel 18/10, satined, also suitable for
"Darbo" portion jam

item	l x w x h in cm
2056.02	9.4x9.4x13.6



4 cruet stand for inserts up to 5x5 cm
stainless steel 18/10, satined

item	l x w x h in cm
2056	11.4x11.4x16



5 cruet stand for inserts up to 7x7 cm
stainless steel 18/10, satined

item	l x w x h in cm
2056.01	15.4x15.4x22.5



6 tray for inserts up to 4x4 cm
stainless steel 18/10, satined, also suitable for
"Darbo" portion jam

item	l x w x h in cm
2057	18.3x4.8x2



7 tray for inserts up to 5x5 cm
stainless steel 18/10, polished, rectangular,
heavy quality, with wide rim, 20.8 cm long,
5.2 cm wide (inside)

item	version	l x w x h in cm
3467.01	smooth	26.8x11.2x2
3467.02	hammered	26.8x11.2x2



8 tray for inserts up to 7x7 cm
stainless steel 18/10, polished, rectangular,
heavy quality, wide rim hammered finish

item	l x w x h in cm	l x w (inside) in cm
3469.02	37.5x15.5x2	29.5x7



3+15+16

6+17+18



8+32+33

... or bread boxes made of wood ...



9 box "Solid" for inserts up to 5x5 cm
walnut, food-safe sealed, not dishwasher-safe, 2 compartments: 10.4 cm x 5.2 cm and 10.4 cm x 16.6 cm, with 4 rubber feet

item	l x w x h in cm
4703	24.4x12.4x4



10 box "Solid" for inserts up to 5x5 cm
walnut, food-safe sealed, not dishwasher-safe, 3 compartments: 2x 10.4 cm x 5.2 cm and 1x 10.4 cm x 16.6 cm, with 4 rubber feet

item	l x w x h in cm
4712	30.2x12.4x4



11 tray "Solid" for inserts up to 5x5 cm
walnut, food-safe sealed, not dishwasher-safe, with 4 rubber feet

item	l x w x h in cm
4719	15.2x15.2x2.5

A suitable insert made of glass is available on page 250.



12 tray "Solid" for inserts up to 5x5 cm
walnut, food-safe sealed, rectangular, not dishwasher-safe, delivery without glass insert item 4708.G (please order separately)

item	l x w x h in cm	l x w (inside) in cm
4708	25.8x10.2x2	20.8x5.2



13 box "Solid" for inserts up to 7x7 cm
walnut, food-safe sealed, not dishwasher-safe, 2 compartments: 14.4 cm x 7.2 cm and 14.4 cm x 14.6 cm, with 4 rubber feet

item	l x w x h in cm
4704	24.4x16.4x4



14 tray "Solid" for inserts up to 7x7 cm
walnut, food-safe sealed, not dishwasher-safe, with 4 rubber feet

item	l x w x h in cm
4719.01	19.5x19.5x2.5



Cruet stands and trays are available in many sizes, variations and materials!

These and a number of suitable inserts are summarized on pages 260 to 264.

The inserts and the compartments of the trays come in three different sizes (4 cm x 4 cm, 5 cm x 5 cm and 7 cm x 7 cm) and will therefore fit for every occasion. Start making your own combinations!

... with suitable inserts made of glass and china ...

inserts up to 4 x 4 cm



15 glass bottle
square, suitable cork item 5297.01
(please order separately)

item	l x w x h in cm	content in l	PU
5296.01	3.9x3.9x8.5	0.04	12 pcs



16 cork
plastic, ecru, for glass bottle item 5296.01

item	Ø in mm	height in mm	PU
5297.01	20/10	22	24 pcs



17 small bowl
white china, square

item	l x w x h in cm	content in l	PU
3844	4x4x3	0.03	24 pcs

3+17+18



5
years
guarantee

on the grinder

18 salt & pepper mill set
acrylic glass, square, with ceramic grinder,
without filling, 5-years guarantee

item	l x w x h in cm	PU
2779	3.7x3.7x9	2 parts

inserts up to 5 x 5 cm



19 glass bottle
square, suitable cork item 5297.02
(please order separately)

item	l x w x h in cm	content in l	PU
5296.02	4.9x4.9x11	0.1	12 pcs



20 cork
plastic, ecru, for glass bottle item 5296.02

item	Ø in mm	height in mm	PU
5297.02	26/15	28	24 pcs

4+21+27



21 glass bottle
square, with swing top (plastic and stainless
steel), height incl. swing top, **only for stainless
steel cruet stand item 2056 (page 261)!**

item	l x w x h in cm	content in l	PU
5295.01	5.4x5.4x12.5	0.1	12 pcs



22 glass bottle/creamer
square, with glass stopper (round), with
notched stopper for pouring with closed lid,
height incl. stopper

item	l x w x h in cm	content in l	PU
5740	5x5x12.5	0.12	3 pcs

10+19+20+23+27



inserts up to 5 x 5 cm

9+19+20+23



12+19+20+23



23 small bowl
glass, transparent, square, delivery without
lid item 5254.01 (please order separately)

item	l x w x h in cm	content in l	PU
5254	4.9x4.9x4.5	0.05	4 pcs



24 small creamer
glass, transparent, square, delivery without
lid item 5254.01 (please order separately)

item	l x w x h in cm	content in l	PU
5255	4.9x4.9x4.5	0.05	4 pcs



25 glass miniature
transparent, lid for mini bowl items 5254
and 5255

item	l x w in cm	PU
5254.01	4.9x4.9	12 pcs



26 small bowl
china, square, 4.9 cm long, 4.9 cm wide,
7 cm high, 0.11 l content

item	version	PU
3855	white	4 pcs
3855.01	black	4 pcs



27 small bowl
china, square, 4.9 cm long, 4.9 cm wide,
4.5 cm high, 0.05 l content

item	version	PU
3845	white	4 pcs
3845.01	black	4 pcs



28 small creamer
white china, square

item	l x w x h in cm	content in l	PU
3849	4.9x4.9x4.5	0.05	4 pcs

... for every purpose!

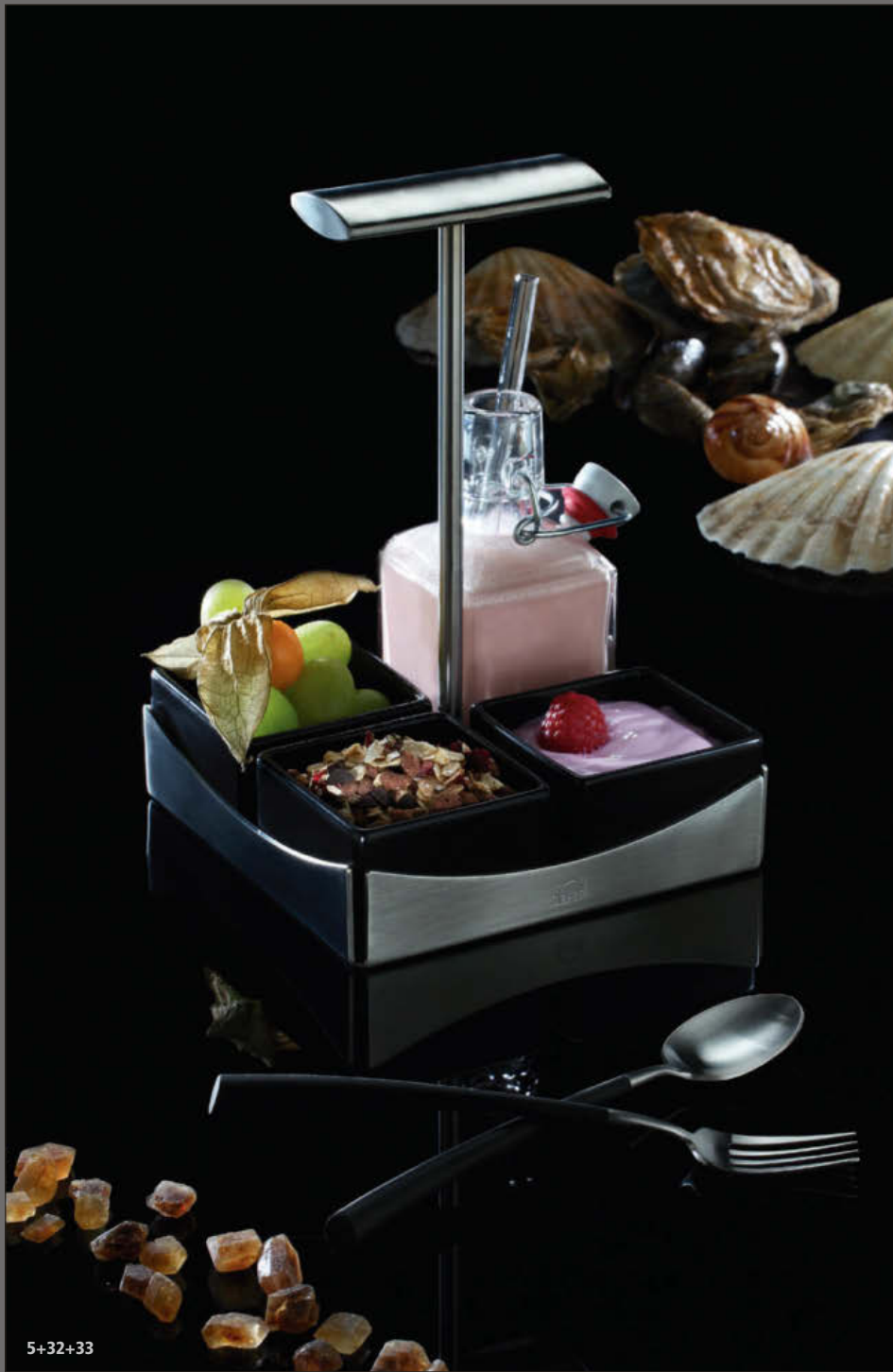

5+32+33



2+29

inserts up to 7 x 7 cm

2+29



29 small bowl
glass, transparent, square

item	l x w x h in cm	content in l	PU
5258	7x7x4.5	0.13	12 pcs



30 glass box
transparent, square, delivery without lid item 5338.01 (please order separately)

item	l x w x h in cm	content in l	PU
5338	7x7x3.9	0.1	12 pcs



31 glass miniature
transparent, lid for glass box item 5338

item	l x w in cm	PU
5338.01	7x7	12 pcs

8+32+33



32 glass bottle
square, with swing top (plastic and stainless steel), height incl. swing top

item	l x w x h in cm	content in l	PU
5295.02	6.7x6.7x14.5	0.2	12 pcs



33 small bowl
china, square, 7 cm long, 7 cm wide, 4.5 cm high, 0.13 l content

item	version	PU
3854	white	4 pcs
3854.01	black	4 pcs



34 small bowl
white china, square

item	l x w x h in cm	content in l	PU
3853	7x7x2	0.05	12 pcs



"Ménage-à-trois"

stainless steel 18/10, for 3 bowls (Ø inside, each 8.4 cm)

item	Ø in cm	height in cm
2058	16.5	18



small bowl "Catering"

white china

item	Ø / height in cm	content in l	PU
4499	8 / 5.5	0.2	6 pcs
4500	8 / 2.5	0.08	12 pcs



small bowl

white china

item	Ø / height in cm	content in l	PU
4498	8 / 6	0.17	6 pcs



glass tumbler

borosilicate glass, transparent, handblown, double-walled

item	Ø / height in cm	content in l	PU
4907	8 / 10	approx. 0.28	6 pcs



glass miniature

transparent, suitable for stainless steel stands items 3468... and 2058

item	Ø / height in cm	content in l	PU
5420	8 / 5	0.13	6 pcs



glass miniature "Milky"

glass, frosted look, suitable for stainless steel stands items 3468... and 2058

item	Ø / height in cm	content in l	PU
5420.01	8 / 5	0.13	6 pcs



small bowl "Halfmoon"

borosilicate glass, transparent, handblown, double-walled

item	Ø / height in cm	content in l	PU
4954.02	8 / 9	approx. 0.17	6 pcs

„Ménage-à-trois“



The vinegar/oil bottle is available on page 279.

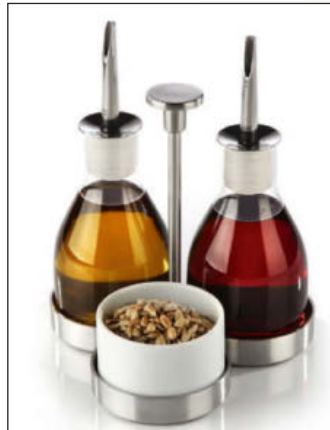

The vinegar/oil bottles in two sizes are available on page 278.





cruet stand

stainless steel 18/10, polished, heavy quality, for inserts with a maximum Ø of 5.3 cm

item	version	l x w x h in cm
a)3466.01	smooth	16x11.5x21
b)3466.02	hammered	16x11.5x21



glass miniature

borosilicate glass, transparent, handblown, double-walled, with reinforced rim

item	Ø / height in cm	content in l	PU
4901.03	5.7 / 7.5	approx. 0.08	6 pcs



glass

transparent, for bridges "Modul" items 4584 and 4724

item	Ø / height in cm	content in l	PU
5405	5 / 8.6	0.1	6 pcs



egg cup "Catering"

white china

item	Ø in cm	height in cm
3977	5	5



creamer

white china, stackable

item	Ø / height in cm	content in l	PU
4489	5.3 / 9	0.13	6 pcs



miniature

china, stackable, Ø 5.3 cm, 7 cm high, 0.1 l content

item	colour	PU
4490	white	6 pcs
4490.01	black	6 pcs

DESIGN
by
ZIEHER



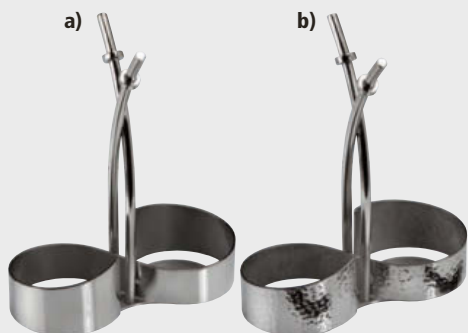

cruet stand

stainless steel 18/10, polished, heavy quality, for inserts with a maximum Ø of 8.2 cm

item	version	l x w x h in cm
a)3468.01	smooth	18.5x8.7x22
b)3468.02	hammered	18.5x8.7x22



vinegar/oil bottle

transparent glass, with stainless steel nozzle, height incl. nozzle

item	Ø in cm	height in cm	content in l
5351	8	21	0.33
5348	8	24.5	0.42



small bowl "Halfmoon"

borosilicate glass, transparent, handblown, double-walled

item	Ø / height in cm	content in l	PU
4954.02	8 / 9	approx. 0.17	6 pcs



small bowl "Catering"

white china

item	Ø / height in cm	content in l	PU
4499	8 / 5.5	0.2	6 pcs



small bowl

white china

item	Ø / height in cm	content in l	PU
4498	8 / 6	0.17	6 pcs



glass miniature

transparent, suitable for stainless steel stands items 3468... and 2058

item	Ø / height in cm	content in l	PU
5420	8 / 5	0.13	6 pcs



glass miniature "Milky"

glass, frosted look, suitable for stainless steel stands items 3468... and 2058

item	Ø / height in cm	content in l	PU
5420.01	8 / 5	0.13	6 pcs



The glass bottles are available on page 278.





DESIGN
by
ZIEHER



The test tubes and test tube holders are available on page 224.



cone stand

massive stainless steel 18/10, hammered finish, six times polished

item	version	l x w x h in cm
2194.03	3 holes (Ø 2.0 cm)	20x5.5x7.5
2194.06	6 holes (Ø 2.0 cm)	21x9.5x10.5



glass cone

transparent, for cone stand items 2194...

item	Ø / height in cm	content in l	PU
5415	3.5 / 8	0.03	12 pcs



etagere

massive stainless steel 18/10, including three removable trays item 2110.01 (30 cm long, 8 cm wide, 3 cm high), hammered finish, six times polished

item	l x w x h in cm (etagere only)
2110	11.5x11.5x39 (height without handle)



tray with feet

massive stainless steel 18/10, rectangular, hammered finish, six times polished, for buffet etagere item 2110

item	l x w x h in cm
2110.01	30x8x3



toast rack

massive stainless steel 18/10, for 4 slices of toast, hammered finish, six times polished

item	l x w x h in cm
2190	20x8.5x15



pastry tray

massive stainless steel 18/10, rectangular, hammered finish, six times polished

item	l x w in cm
2136	30x12.5



Etageres



etagere

massive stainless steel 18/10, hammered finish, polished, 3 or 4 insertion levels (Ø inside: 6.5 cm) for plates/bowls with max. Ø 11 cm

item	l x w x h in cm	levels
2107.03	12.5x11.5x23	3
2107.04	12.5x11.5x29	4



New!



etagere with mini plates

set consists of:

etagere made of massive stainless steel 18/10, hammered finish, polished, with four insertion levels (Ø inside: 6.5 cm) for plates/bowls with max. Ø 11 cm
mini plate (5 pcs incl. 1 replacement plate), stoneware, black, matt, round, flat, Ø 10.5 cm
 1 set in black gift box

item	l x w x h in cm	PU
2106.04PB	12.5x11.5x29	1 set (6 parts)



New!



1 miniature plate

stoneware, round, flat, Ø 10.5 cm

item	colour	PU
4606.10	white, glossy/matt underside	12 pcs
4607.10	black, matt	12 pcs



2 miniature plate "Catering"

white china, flat, coup form

item	Ø in cm	PU
3954.08	8	12 pcs



3 miniature plate

white china, flat

item	l x w in cm	PU
4240.10	10x10	12 pcs



4 miniature plate

white china, flat, oval

item	l x w x h in cm	PU
4324.11	11x9x1.8	12 pcs



5 glass miniature

glass, transparent, flat, oval

item	l x w x h in cm	PU
5443	11x9x1.7	6 pcs



New!

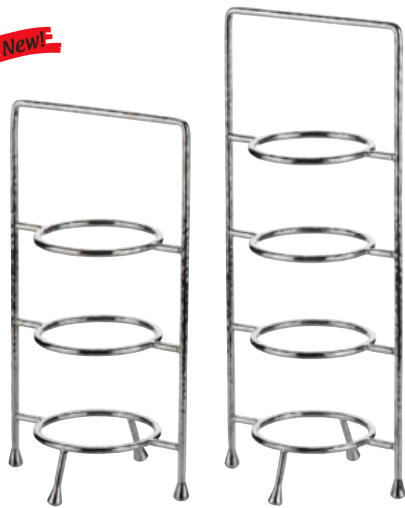

etagere

massive stainless steel 18/10, hammered finish, polished, 3 or 4 insertion levels (Ø inside: 10.8 cm) for plates/bowls with max. Ø 17.5 cm

item	l x w x h in cm
2105.03	20.5x18x37.5
2105.04	20.5x18x47.5

Elegantly served and presented in style - Classic plate etageres, newly inspired!

Shapely and individual stands by Zieher are suitable for numerous applications. The classic plate etageres are available with three or four levels and in two sizes. The classic mini format etageres effectively present petit fours, desserts, chocolates or other delicacies. The larger versions are ideal for scones and jam during Five O'Clock Tea, but also a choice of cold cuts, cheese or fruit can be staged elaborately on the set table.



New!

etagere with plates

set consists of:

etagere made of massive stainless steel 18/10, hammered finish, polished, with three insertion levels (Ø inside: 10.8 cm) for plates/bowls with max. Ø 17.5 cm

plate (4 pcs incl. 1 replacement plate), stoneware, black, matt, round, flat, Ø 17 cm
1 set in black gift box

item	l x w x h in cm	PU
2103.03PB	20.5x18x37.5	1 set (5 parts)

New!



1 plate
stoneware, round, flat, Ø 17 cm

item	colour	PU
4606.17	white, glossy/matt underside	4 pcs
4607.17	black, matt	4 pcs

New!



2 tray
massive stainless steel 18/10, square, with feet, hammered finish, six times polished

item	l x w x h in cm
2101.17	17.5x17.5x2.3



3 glass plate
black, flat, hammered optic, dishwasher-safe

item	Ø in cm	PU
5730.18	18	3 pcs



"Jam-Trays"

5428.04 + 5408.01



Also suitable for tealights



jam tray

glass, transparent, 4 deepenings (Ø 4.6 cm), for inserts and portion jam up to Ø 4.4 cm (e. g. "Darbo" portion jam, 28 g and 40 g)

item	l x w x h in cm	PU
5428.04	23.5x6.2x3	6 pcs



jam tray

stainless steel 18/10, polished, for e.g. "Darbo" portion jam (28 g and 40 g), portion ketchup or mustard

item	version	l x w in cm
2191.03	3 holes (Ø 4.5 cm)	19.5x7.5
2191.04	4 holes (Ø 4.5 cm)	24x7.5



glass miniature

transparent, for jam tray items 2191... and jam tray item 5428.04

item	Ø / height in cm	content in l	PU
5408.01	4.6 / 6.8	0.05	6 pcs
5408.02	4.6 / 9.3	0.09	6 pcs



tray

stainless steel 18/10, satiné, also suitable for "Darbo" portion jam, for inserts up to 4 cm x 4 cm

item	l x w x h in cm
2057	18.3x4.8x2

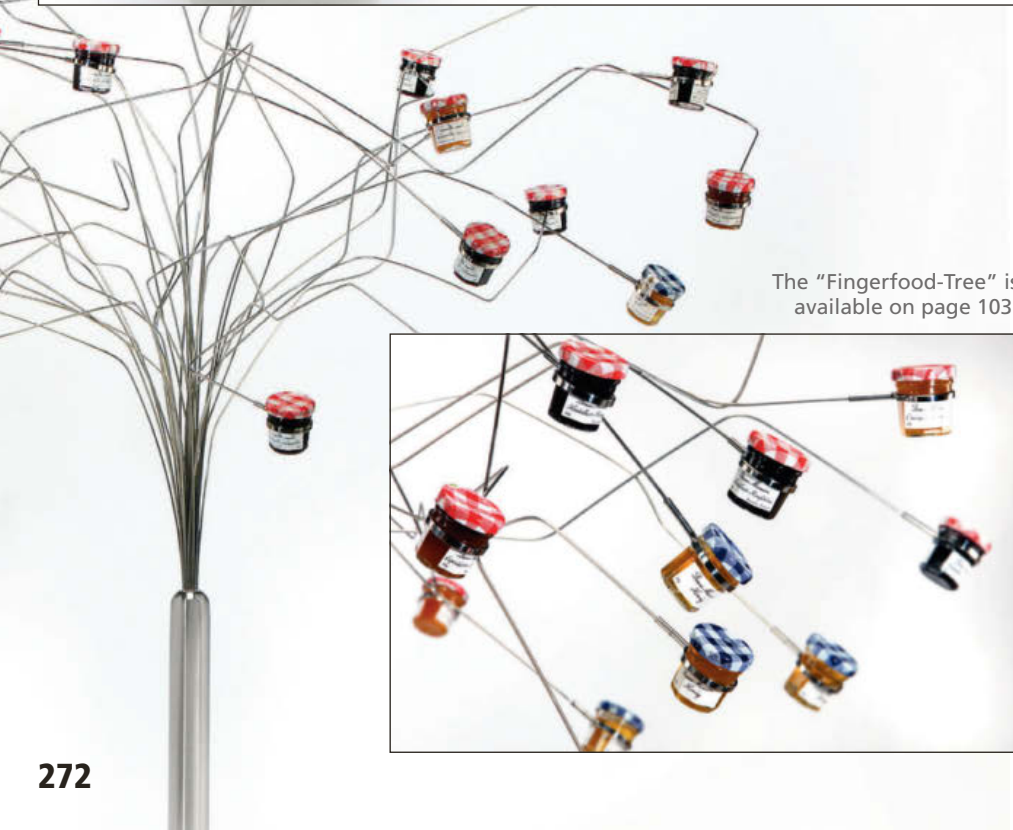

The "Fingerfood-Tree" is available on page 103.

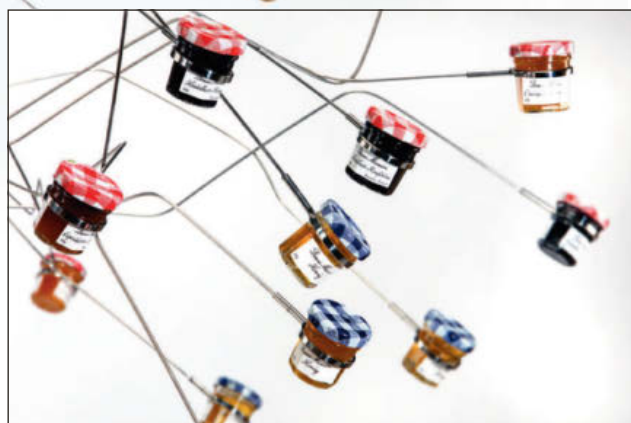

"Five o' Clock Tea"

The cloche item 4982.11 is available on page 192.



etagere/pastry stand

massive stainless steel 18/10, smooth finish, six times polished, 4-armed (6 cm distance between the trays), not demountable

item	Ø trays in cm	height in cm
2189	2x14 / 2x18	25

etagere/pastry stand

in black gift box

item	Ø trays in cm	height in cm
2189.PB	2x14 / 2x18	25

The glass cloches and more sizes are available on pages 189 to 193.



2188.14 + 4982.11

2188.14 + 4982

2188.22 + 4880.18

2188.27 + 4880.26



tray

massive stainless steel 18/10, round, smooth finish, six times polished, with raised edge

item	Ø in cm	height in cm
2188.14	14	1.5
2188.18	18	1.5
2188.22	22	2
2188.27	27.5	2



etagere

massive stainless steel 18/10, triangular, smooth finish, six times polished, not demountable

item	Ø in cm	height in cm
2187	13	16.5



Trays made of melamine ...

More trays made of melamine are available on page 134, the table spoon "Goa" on page 300.



tray

melamine, black, surface matt, food-safe, dishwasher-safe, not suitable for microwave and combi steam oven

item	l x w x h in cm	PU
4586	25.2x13.2x1.8	2 pcs



GN tray

melamine, black, surface matt, food-safe, dishwasher-safe, not suitable for microwave and combi steam oven

item	l x w x h in cm	GN	PU
4587	32.5x17.6x1.8	1/3	2 pcs
4588	32.5x26.5x1.8	1/2	2 pcs
4589	53x32.5x1.8	1/1	2 pcs



The glass bowl item 5444 is available on page 275.



tray

melamine, black, surface matt, with 3 oval sockets (diagonal), food-safe, dishwasher-safe, not suitable for microwave and combi steam oven, for small bowls items 4081.12 (china) and 5444 (glass)

item	l x w x h in cm	PU
4593	32.5x13.2x1.8	2 pcs

Suitable for items with a bottom diameter of less than 5.5 cm or 8.2 cm



2/8 GN tray

melamine, black, surface matt, with 3 round sockets (Ø 5.5/8.2 cm), food-safe, dishwasher-safe, not suitable for microwave and combi steam oven

item	l x w x h in cm	PU
4590	32.5x13.2x1.8	2 pcs



The china bowl "Duo" is available on page 232.



spoon rest "Modul"

melamine, black, surface matt, with 4 rubber feet (black), food-safe, dishwasher-safe, not suitable for microwave and combi steam oven

item	l x w x h in cm	PU
4585	20x5x4	2 pcs

The trays made of melamine in well-established GN-size can be equipped with many items.
A wide range of different miniatures is available on pages 210 to 244.



Trays made of glass are available on page 276.

... for item 4590



creamer

white china, stackable

item	Ø / height in cm	content in l	PU
4489	5.3 / 9	0.13	6 pcs



miniature

china, stackable, Ø 5.3 cm, 7 cm high, 0.1 l content

item	colour	PU
4490	white	6 pcs
4490.01	black	6 pcs



glass miniature

borosilicate glass, transparent, handblown, double-walled

item	Ø / height in cm	content in l	PU
4903	5.5 / 8.5	approx. 0.1	6 pcs



glass

item	Ø / height in cm	content in l	PU
5380	7.5 / 10.5	0.32	6 pcs
5381	7.5 / 6	0.18	6 pcs



glass bottle

with swing top (PVC lid), height incl. swing top

item	Ø / height in cm	content in l	PU
5290.02	5.5 / 19	0.2	12 pcs



small bowl "Catering"

white china

item	Ø / height in cm	content in l	PU
4499	8 / 5.5	0.2	6 pcs
4500	8 / 2.5	0.08	12 pcs



small bowl

white china

item	Ø / height in cm	content in l	PU
4498	8 / 6	0.17	6 pcs



glass miniature

transparent, suitable for stainless steel stands items 3468... and 2058

item	Ø / height in cm	content in l	PU
5420	8 / 5	0.13	6 pcs



glass miniature "Milky"

glass, frosted look, suitable for stainless steel stands items 3468... and 2058

item	Ø / height in cm	content in l	PU
5420.01	8 / 5	0.13	6 pcs



small bowl "Halfmoon"

borosilicate glass, transparent, handblown, double-walled

item	Ø / height in cm	content in l	PU
4954.02	8 / 9	approx. 0.17	6 pcs



glass tumbler

borosilicate glass, transparent, handblown, double-walled

item	Ø / height in cm	content in l	PU
4907	8 / 10	approx. 0.28	6 pcs

... for item 4593



bowl

glass, transparent, oval

item	l x w x h in cm	content in l	PU
5444	12.5x7x4	0.08	6 pcs



bowl

white china, oval

item	l x w x h in cm	content in l	PU
4081.12	12.5x7.5x4	0.1	12 pcs

Trays made of glass ...



glass tray

deep black, rectangular, for buffet or flying buffet, also functions as a tray

item	l x w x h in cm
5141.26	26x14x2
5141.34	34x18x2
5141.50	51x35x2



glass tray

deep black, square, for buffet or flying buffet, functions as a tray or as a dinner plate

item	l x w x h in cm
5142.34	35x35x2



glass tray

deep black, with 3 oval sockets (diagonal, 4.7 cm x 8.5 cm at bottom area), for small bowl items 4081.12 (china) and 5444 (glass)

item	l x w in cm
5143	32x15



glass tray

deep black, with 3 round sockets (Ø 6 cm at bottom area)

item	l x w in cm
5145	32x12

The cocktail glass is available on page 222.

DESIGN
by
ZIEHER



items 5145 + 4962

... for item 5143



bowl
white china, oval

item	l x w x h in cm	content in l	PU
4081.12	12.5x7.5x4	0.1	12 pcs



bowl
glass, transparent, oval

item	l x w x h in cm	content in l	PU
5444	12.5x7x4	0.08	6 pcs

... for item 5145



small bowl
white china, deep, oval

item	l x w x h in cm	content in l	PU
4326.11	11x9x3.8	0.1	12 pcs



glass miniature
glass, transparent, deep, oval

item	l x w x h in cm	content in l	PU
5442	11x9x3.8	0.09	6 pcs



bowl "Duo"
white china

item	l x w x h in cm	content in l	PU
4231.50	13x7x3.5	0.08	12 pcs



glass tray with bowls

set consists of:
glass tray, deep black
3 china bowls "Duo", white, 0.08 l content each
1 set in black gift box

item	l x w in cm	PU
5135.PB	32x12	1 set (4 parts)



bowl "Duo"
glass, transparent

item	l x w x h in cm	content in l	PU
5441	11.5x7x3.5	0.07	6 pcs

More sizes are available on page 223.



small bowl "Halfmoon"
borosilicate glass, transparent, handblown, double-walled

item	Ø / height in cm	content in l	PU
4954.01	6 / 7.5	approx. 0.08	6 pcs

... with suitable inserts!

The cutlery "Goa" is available on page 300.



glass

item	Ø / height in cm	content in l	PU
5380	7.5 / 10.5	0.32	6 pcs
5381	7.5 / 6	0.18	6 pcs



miniature bowl "Spobo" with spoon rest
white china, for spoons with a total length of 12 cm and over

item	Ø / height in cm	content in l	PU
4230.11	10.5 / 3.9	0.07	12 pcs



miniature bowl "Spobo" with spoon rest
glass, transparent, for spoons with a total length of 12 cm and over

item	Ø / height in cm	content in l	PU
5440	10 / 4	0.08	6 pcs

The tray item 4702 is available on page 250.

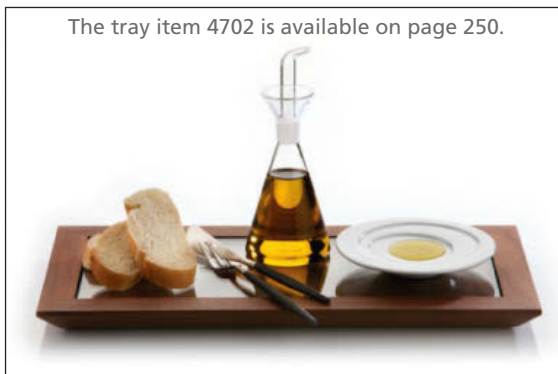

vinegar/oil bottle

transparent glass, with stainless steel nozzle, height incl. nozzle

item	Ø in cm	height in cm	content in l
5351	8	21	0.33
5348	8	24.5	0.42



vinegar/oil bottle

transparent glass, with glass stopper

item	Ø / height in cm	content in l	PU
5317	8 / 15.5	0.23	2 pcs

cork

for vinegar/oil bottle item 5317

item	Ø in cm	length in cm	PU
1502	1.7/1.4	2.2	24 pcs

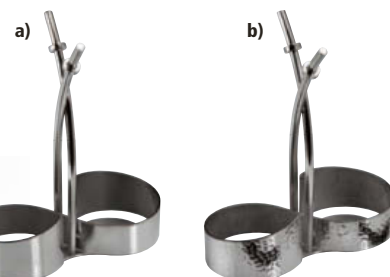

cruet stand

stainless steel 18/10, polished, heavy quality, for inserts with a maximum Ø of 8.2 cm

item	version	l x w x h in cm
a)3468.01	smooth	18.5x8.7x22
b)3468.02	hammered	18.5x8.7x22

Spices



marble mortar

black/brown, outside polished, with pestle

item	Ø in cm	height in cm
8037	9.5	5
8038	20	12



vinegar/oil bottle

borosilicate glass, transparent, handblown and handmade, with 2 corks

item	content inside / outside in l	height in cm
4993	0.075 / 0.3	19



vinegar/oil bottle

borosilicate glass, transparent, handblown and handmade, with 2 corks

item	content inside / outside in l	height in cm
4983	0.05 / 0.45	25

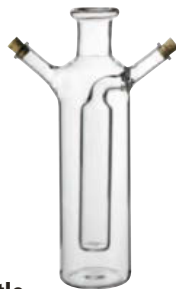

vinegar/oil bottle

borosilicate glass, transparent, handblown and handmade, with 2 corks

item	content inside / outside in l	height in cm
4984	0.04 / 0.2	19



vinegar/oil bottle

borosilicate glass, transparent, handblown and handmade, with 2 corks

item	content inside / outside in l	height in cm
4985	0.08 / 0.27	16.5



vinegar/oil bottle

borosilicate glass, transparent, handblown and handmade, with spout

item	content in l	height in cm
4986	0.15	16.5

Vinegar & oil

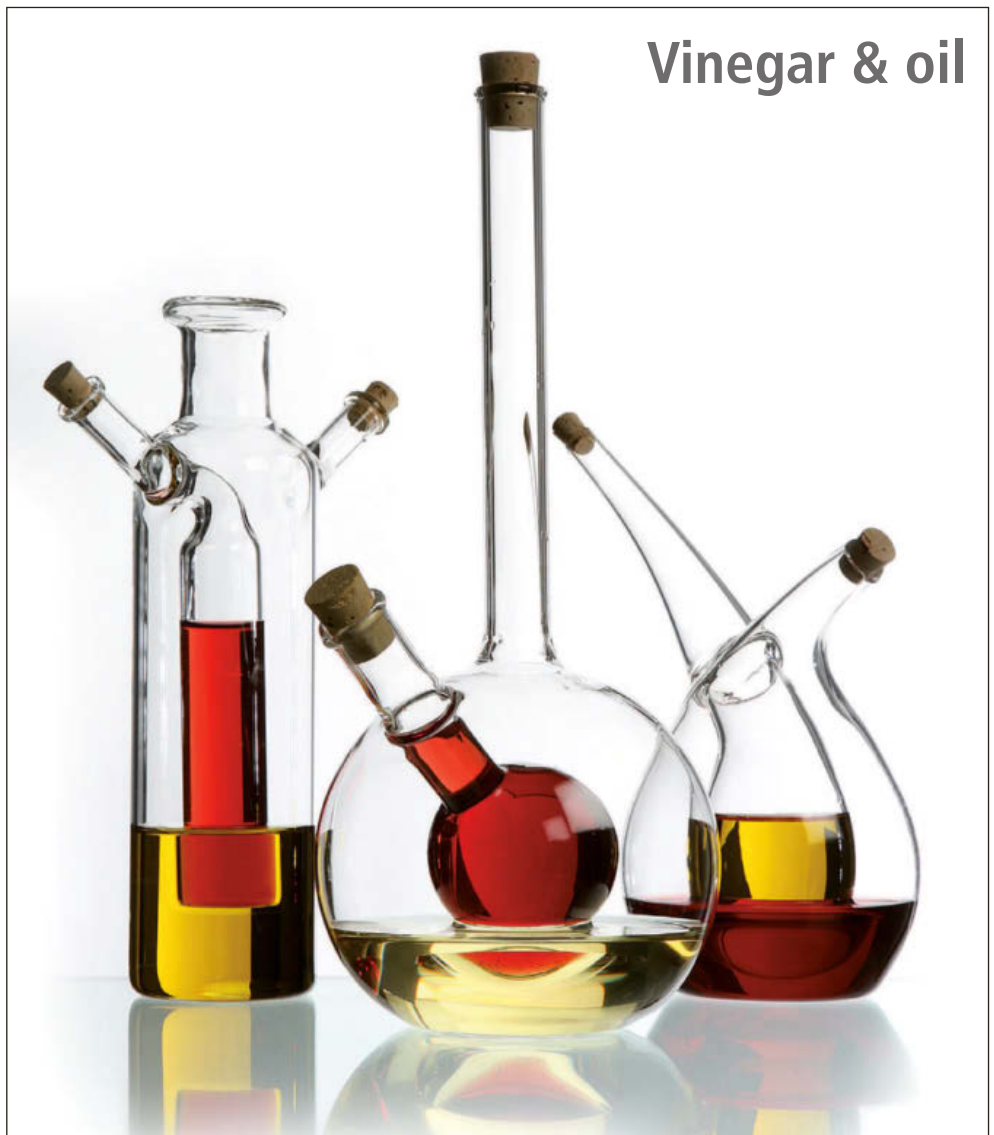

The cruet stand item 2058 is available on page 265.





The stepped drillings in our wind lamps made of walnut allow the usage of Zieher LED tealights (page 283) as well as standard tealights with a diameter of 38 mm and 58 mm.

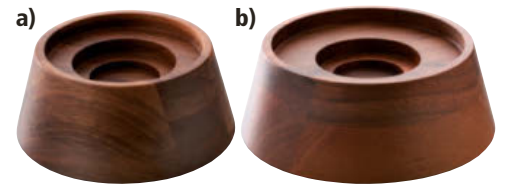

a) tealight holder "Solid"

walnut, round, food-safe sealed, not dishwasher-safe, with stepped hole (for small (Ø 4 cm) and large (Ø 6 cm) tealights), for wind lamp items 4987... and wind lamp item 4991.02

item	Ø in cm	Ø inside in cm	height in cm
4714	13.4	9.4	5.5

b) tealight holder "Solid"

walnut, round, food-safe sealed, not dishwasher-safe, with stepped hole (for small (Ø 4 cm) and large (Ø 6 cm) tealights), for wind lamp items 4988... and wind lamp item 4992.02

item	Ø in cm	Ø inside in cm	height in cm
4715	15.4	11.4	5.5

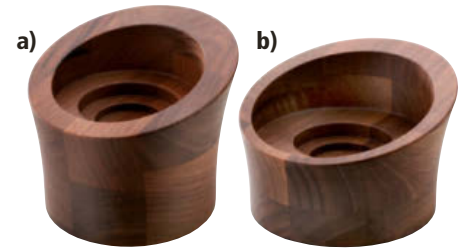

a) tealight holder "Solid"

walnut, oblique, food-safe sealed, not dishwasher-safe, with stepped hole (for small (Ø 4 cm) and large (Ø 6 cm) tealights), for wind lamp item 4991.02

item	Ø in cm	Ø inside in cm	height in cm
4716	13	9.4	10.5

b) tealight holder "Solid"

walnut, oblique, food-safe sealed, not dishwasher-safe, with stepped hole (for small (Ø 4 cm) and large (Ø 6 cm) tealights), for wind lamp item 4992.02

item	Ø in cm	Ø inside in cm	height in cm
4717	14	11.4	9

Suitable bread bowls "Solid" are available on page 251.



a) slate coaster

slate, with feet of felt, Ø opening for tealights: 4 cm, Ø ring outside 8 - 9 cm: for wind lamp glass items 4987... and wind lamp glass item 4991.02

item	l x w x h in cm	PU
8043.01	13x13x2	4 pcs

b) slate coaster

slate, with feet of felt, Ø opening for jumbo tealights: 6 cm, Ø ring outside 10 - 11.6 cm: for wind lamp glass items 4988..., 4992.02 and wind lamp china item 4397

item	l x w x h in cm	PU
8043.02	16x16x3	3 pcs



slate coaster

slate, with feet of felt, Ø opening for regular and jumbo tealights: 6.7 cm, for wind lamp item 4994.02

item	l x w x h in cm	PU
8053	10x10x1	6 pcs



wind light

borosilicate glass, satined inside, open at the top and at the bottom, for slate coaster item 8053

item	Ø in cm	height in cm	PU
4994.02	6.5	10	6 pcs

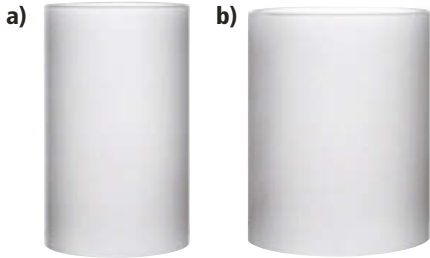

a) wind light

borosilicate glass, satined inside, open at the top and at the bottom, for slate coaster item 8043.01 and for wooden saucers items 4714 and 4716

item	Ø in cm	height in cm	PU
4991.02	9	14.5	6 pcs

b) wind light

borosilicate glass, satined inside, open at the top and at the bottom, for slate coaster item 8043.02 and for wooden saucer items 4715 and 4717

item	Ø in cm	height in cm	PU
4992.02	11	13.5	6 pcs



wind light

borosilicate glass, transparent, with 3 notches at the bottom, open at the top, handmade, for slate coaster items 8043.01 and 8043.02

item	Ø in cm	height in cm
4987.01	9	approx. 12-13
4988.01	11	approx. 13-14



wind light

borosilicate glass, satined (inside), with 3 notches at the bottom, open at the top, handmade, for slate coaster items 8043.01 and 8043.02

item	Ø in cm	height in cm
4987.02	9	approx. 12-13
4988.02	11	approx. 13-14



Please note: The wind lights made of glass (items 4987... and 4988...) can get very hot if wax candles are used for longer burning times. We recommend to use our LED tealights (page 283). The saucers "Solid" items 4700.01 and 4700.02 are available on page 252.





The saucer made of slate item 8043.02 is available on page 280.



wind light

biscuit china, white, translucent, with a round, oblique opening, suitable for items 4398 and 8043.02

item	Ø in cm	height in cm	PU
4397	11	13.5	6 pcs



saucer

biscuit china, white, inner circle glazed (Ø 9.5 cm), for round items with an inner diameter of 10.5 cm

item	Ø in cm	height in cm	PU
4398	11.5	1.3	6 pcs

wind light with saucer

set consists of:

wind light made of biscuit china, white, translucent, with a round, oblique opening

saucer made of biscuit china, white, inner circle glazed (Ø 9.5 cm),

1 set in black gift box

item	Ø in cm	height in cm	PU
4399.PB	11.5	14,8	1 set (2 parts)



The complete series "DressCoat" is available on pages 150 and 151.

"DressCoat"

The plateau plate "DressCoat" item 4386.02B is unglazed on the outside. The filigree porcelain item is translucent and is therefore - besides being a stunning means to present food - also perfectly suitable as a tea light holder!



plateau plate "DressCoat"

white china, outside unglazed, useable area (plateau, glazed): Ø 6.5 cm, also useable as wind light and bowl

item	Ø / height in cm	content in l	PU
4386.02B	8 / 4	0.09	12 pcs



Consistently long lighting time with deceptively real flickering effect!

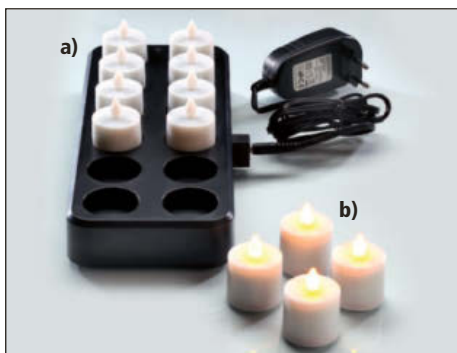

a) LED tealight set

plastic, set consisting of one induction charging station black and 12 white LED-tealights (Ø 4 cm, 5 cm high, yellow light, flickering effect), delivery without power supply items 8132... (please order separately)

item	l x w x h in cm
8130	30.5x13.5x4

b) LED tealight

plastic, white, yellow light, flickering effect, for LED tealight set item 8130

item	Ø in cm	height in cm	PU
8131	4	5	4 pcs

The LED-candles, in combination with different fitting Zieher tealight holders, turn every table into a homelike place for romantic hours. The power supplies, which are available separately, optionally with EU-, UK- or US-plug, guarantee a worldwide operation of the LED set. Due to the induction charging mechanism, the LED-candles do not have any electrical contacts. This and their water resistance (not waterproof) make them ideal for outdoor use. Each tealight candle is equipped with a yellow shining LED and by skilfully switching between bright and dark, it achieves a deceptively real candle flickering effect. The rechargeable battery, which is integrated in the LED-candle, assures a lighting time of 20 hours with a charging time of about 8 - 9 hours and a lifetime of more than 500 charging cycles (this equates about 10.000 operating hours). The induction charging base, which is included in the set (item 8130), allows the charging of up to 12 LED-candles at the same time. Another plus is the integrated plug connection which allows to connect up to 4 charging bases to one single power supply. This enables the charging of up to 48 LED-candles with one electrical socket at the same time. One set (item 8130) includes 12 LED-candles and 1 induction charging base. The respective power supply (item 8132. EU/UK/US) needs to be ordered separately.

Bring the romantic atmosphere of candles to your own table - via modern LED technology!

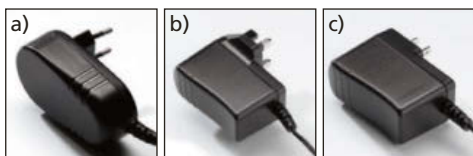

power supply

for LED tealight set, up to 4 LED tealight sets (total of 48 candles) can be connected using 1 power supply only

item	version
a)8132.EU	Europe
b)8132.UK	UK
c)8132.US	USA



ashtray for cigars

optical glass, transparent, also usable as a rest for tongs or spoons, in black gift box

item	l x w x h in cm
5210	15x9x3



Please note: the trays items 4707.PB and 4706 are not suitable for tray stand item 4748 (page 286).



servicing tray "Solid"

walnut, flat, food-safe sealed, not dishwasher-safe, with 2 recessed grips, with 4 rubber feet, in black gift box

item	l x w x h in cm	l x w (inside) in cm
4707.PB	53x37x4	50.2x34.2



glass platter

special hardened safety glass, rectangular, rounded edges, polished rim, dishwasher-safe, rubber feet included (adhesive), underside scratch-proof, 4 mm thick, for serving trays "Solid" items 4707.PB and 4740

item	version	l x w in cm
1668.03	black glass	50x34
1670.03	white glass	50x34



servicing tray "Solid"

walnut, food-safe sealed, not dishwasher-safe, with 2 handles, with 4 rubber feet, utility space: 44.5 cm x 30 cm

item	l x w x h in cm
4706	50x30x5



cutlery/napkin box "Solid"

walnut, food-safe sealed, not dishwasher-safe, with rubber feet in the lid (soft closure, can be opened to an angle of 90°) and at the bottom, with black felt insert, stainless steel platter with space for an engraving (price and quantity upon request), 15.5 cm height with opened lid

item	l x w x h in cm	size inside in cm
4766	28.8x11.8x6	26x9



**Room service
Guestrooms**

"Solid"



DESIGN
by
ZIEHER



More items of the series "Solid" for the buffet are available on pages 104 to 117.



glass platter 2/1 GN

hardened glass, edges polished and deburred, 65 cm long, 53 cm wide, 10 mm thick

item	version
8004.07	transparent
8004.07B	dark grey

The tray stand of the series "Solid" convinces in every aspect!

The shapely stand always provides the appropriate possibility to set up the "Solid" room service tray (item 4735) in the hotel room but also in the restaurant. Combined with Zieher buffet platters in the format 2/1 GN, the stand easily and flexibly creates new spaces at a comfortable height. It is predestined for the use at the buffet as well as for the use during coffee breaks in the congress and convention business. The massive frame made of walnut wood harmonizes perfectly with other buffet items of the series (pages 104 to 117) and can be combined with them very well. Anti-slip rubber feet on the top prevent the shifting of platters and trays, felt gliders at the base protect the parquet flooring and ensure safe standing.



Anti-slip rubber feet on the top



Felt gliders at the base



tray stand/side table "Solid"

walnut, with black nylon ribbons, anti-slip rubber feet on top and felt gliders at the bottom, suitable for trays and buffet platters in sizes starting from 55 cm x 36 cm, 1.02 m high (folded up), 87 cm high (opened)

item	l x w x h (opened) in cm
4748	54.5x36x87

Breakfast in bed - Inroom dining!



New!

bed tray „Solid“

walnut, with feet, food-safe sealed, not dishwasher-safe, stackable, with 2 handles, recessed on one side of the rim

item	l x w x h in cm closed	l x w x h in cm set up
4773.PB	60x40x6.5	approx. 74x40x31



The rubber feet at the base are set back from the rim to enable the transport on a tray trolley in 1/1 EN-format (60 cm x 40 cm).



roomservice tray "Solid"

walnut, food-safe sealed, stackable, 2 handles, recessed on one side of the rim, not dishwasher-safe, with 4 rubber feet, suitable for tray stand "Solid" item 4748

item	l x w x h in cm
4735	60x40x5.4



The roomservice tray as well as the new bed tray stand out due to the precious walnut which is incorporated into these products with high-quality craftsmanship. The recessed longside enables comfortable dining directly off the tray. The retractable feet of the bed tray have been constructed in a very stable way and are securely kept in position by integrated magnets when folded in. The height of the erected tray has been chosen in a way that even with soft mattresses a comfortable seating beneath the tray is guaranteed. So start off the day with a boundlessly relaxing breakfast in bed!



The recessed longside of the roomservice tray simplifies comfortable dining directly off the tray.

Please note the care instructions: wooden items are not dishwasher-safe, do not immerse in water!

"Solid"



1 + 2 + 4



Hotelcosmetic: PAM Berlin Slipper & Hotel Supplies - www.pam-berlin.de



storage/presentation box "Solid"

walnut, food-safe sealed, not dishwasher-safe, with sliding lid

item	l x w x h in cm	size inside in cm
4762.18	18x18x6	approx. 16x16x4.2
4762.24	24x24x8	approx. 22x22x6.2
4762.30	30x30x10	approx. 28x28x8.2



box/tray "Solid"

walnut, food-safe sealed, not dishwasher-safe, with 4 rubber feet

item	l x w x h in cm	l x w (inside) in cm
4713	34x34x3	32x32



tray "Solid"

walnut, food-safe sealed, rectangular, not dishwasher-safe, delivery without glass insert item 4702.G (please order separately)

item	l x w x h in cm	l x w (inside) in cm
4702	36x18x2	31x13



glass insert/saucer

transparent, with 4 transparent rubber feet, suitable for tray "Solid" item 4702

item	l x w x h in cm	PU
4702.G	30.9x12.9x0.4	2 pcs

More items of the "Solid" series in the areas of buffet and tabletop are available on pages 104 to 117 and 244 to 256.



1 storage/presentation box "Solid"

walnut, food-safe sealed, not dishwasher-safe, with sliding lid made of wood, also available with glass lid item 4762.18G (please order separately)

item	l x w x h in cm	size inside in cm
4762.18	18x18x6	approx. 16x16x4.2



2 glass lid

brown tinted, with recess, for storage/presentation box "Solid" item 4762.18

item	l x w in cm
4762.18G	17.3x16.7

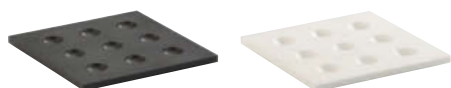

3 insert for chocolates

solid surface material, with 9 cavities (Ø 2.2 cm), for storage/presentation box "Solid" item 4762.18

item	version	l x w x h in cm
4763.01S	black	15.8x15.8x1
4763.01W	white	15.8x15.8x1

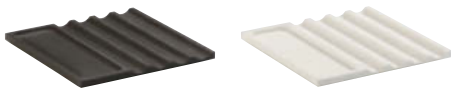

4 insert for cigars

solid surface material, for 4 cigars (grooves 1.9 cm wide), storage area for accessories (14.8 cm x 4.8 cm), for storage/presentation box "Solid" item 4762.18

item	version	l x w x h in cm
4763.02S	black	15.8x15.8x1
4763.02W	white	15.8x15.8x1

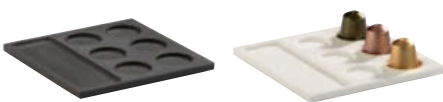

5 insert for coffee capsules

solid surface material, with 6 cavities (Ø 3.8 cm), storage area for accessories (14.8 cm x 4.8 cm), for storage/presentation box "Solid" item 4762.18

item	version	l x w x h in cm
4763.03S	black	15.8x15.8x1
4763.03W	white	15.8x15.8x1



6 insert/platter

solid surface material, white, usable area: 14.8 cm x 14.8 cm, for storage/presentation box "Solid" item 4762.18

item	l x w x h in cm
4763.04W	15.8x15.8x1

1 + 2 + 3



1 + 2 + 5

Delicacies in delicate setting – presentation boxes made by Zieher!

Due to the comprehensive range of accessories the small-sized box offers multiple application possibilities. The box, regularly fitted with a wooden sliding lid, can be equipped with several optionally available inserts made of top-quality solid surface material. The also available lid made of brown-tinted glass puts the presented goods in the limelight.

Apart from an insert with round cavities for nine truffles/chocolates and a flat plate that can be used for layered chocolates, various little somethings or amuse bouches, there is also an insert available for commercial coffee capsules.



1 + 2 + 6

The insert for cigars can hold up to four cigars and a separate compartment aside offers additional space for matches, cigar cutters, etc. No matter if it is an assortment of coffee specialities or various delicacies of the pâtisserie, the presentation box by Zieher provides the perfect setting for many purposes.



1 + 2



1 + 2 + 5



Bedded on glass

This variant of the "Donna" pillow is made of frosted glass and despite its hard and massive raw material it surprises by its pleasantly soft and velvety feel.

The organic shape of this extraordinary piece offers an ideal presentation area for extravagantly staged intermediate courses or serves as a fancy place to keep all sorts of small objects of everyday life.

Even when used as a soap dish, the pillow cuts a good figure. A version made of porcelain is available on page 142.



New

glass pillow "Donna"
glass, satined, in black gift box

item	l x w x h in cm
5446.01PB	16.5x11x3

The platter "Collina" is available on page 157.



The porcelain pillow "Donna" is available on page 142.



Bedded on wood

Made of solid wood, milled with dedication and refined with high quality oils!

This sculpture of solid walnut, one of the finest European varieties of wood, has its own appearance. The sealing with oils emphasises the striking grain of the wood and gives the surface a silk-matt gloss as well as amazing haptics.

One just has to touch the softly curved forms of this hand charmer. Whether used as a fruit bowl, as a place to keep accessories or as sculptural decoration - "Donna" seduces in every material!



DESIGN
by
ZIEHER



New!

wooden pillow "Donna"

solid walnut, oiled, not dishwasher-safe, 4 rubber feet, in black gift box

item	1 x w x h in cm
4772.33PB	33.5x22.5x7



The cloches are available on page 189.

"Capiz"



Hotelcosmetic: PAM Berlin Slipper & Hotel Supplies www.pam-berlin.de



tray "Capiz"

shell, ivory-coloured, resin-coated, square, not dishwasher-safe

item	l x w x h in cm
7103.20	20x20x2
7103.26	26x26x2

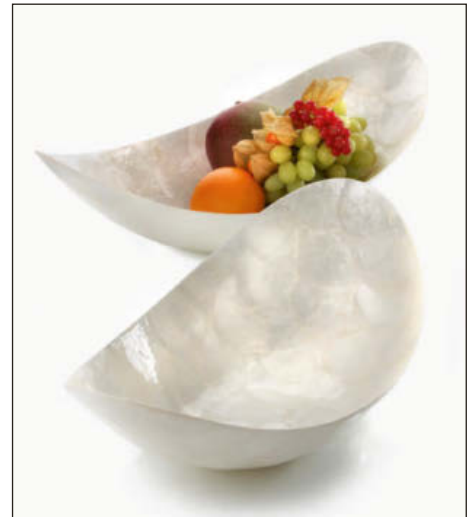

Ivory-coloured clamshells with nacreous gloss grant these products their special appeal.

The champagne bowls "Capiz" are available on page 71.



bowl "Capiz"

shell, ivory-coloured, resin-coated, oval, not dishwasher-safe

item	l x w x h in cm
7106.46	46.5x24x13.5

More items of the series "Capiz" are available on pages 174 and 175.



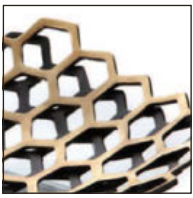

bowl "Matrix"

brass, top golden (transparent coating, food-safe), bottom dark patinated, hexagonal, flat, not dishwasher-safe

item	Ø in cm	height in cm
2382.38	38	7

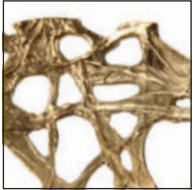

bowl "Roots"

brass, golden (transparent coating, food-safe), round, not dishwasher-safe

item	Ø in cm	height in cm
2381.38	38	8

bowl "Roots"

in black gift box

item	Ø in cm	height in cm
2381.38PB	38	8



"Reef"

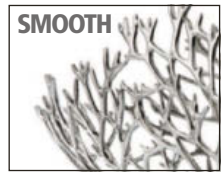

bowl/basket "Reef"
pewter, smooth outside, round, with supporting feet, food-safe, not dishwasher-safe, for small glass bowl item 5166 (please order separately)

item	Ø in cm	height in cm
2310	13	8



small bowl
glass, dark grey, organically shaped, 6 mm thick, for bowl/basket "Reef" item 2310 (please order separately)

item	Ø / height in cm	content in l	PU
5166	13 / 6.5	approx. 0.3	2 pcs



bowl/basket "Reef"
pewter, smooth outside, flat, round, food-safe, not dishwasher-safe

item	Ø in cm	height in cm
2311	22	5

More items with structured surface are available on page 67.



bowl/basket "Reef"
pewter, smooth outside, high, round, food-safe, not dishwasher-safe

item	Ø in cm	height in cm
2312.01	36	45
2312.02	23	36

The bowls and baskets of the "Reef" series are veritable eye-catchers due to their organic structure and exceptional shapes. An assortment of bread and fruit in the hotel room or on the buffet table is put perfectly into the limelight by the transparency of the "Reef" items; carefully draped towels are also exquisitely presented in the bathroom or in the spa area.



bowl/basket "Reef"
pewter, smooth outside, oval, food-safe, not dishwasher-safe

item	l x w x h in cm
2313.01	46x19x20
2313.02	32x13x13

In-Room Dining - "Podia"



Please note: by reason of manufacturing, deviations from the declared measurements of the bridges may occur!



buffet bridge "Podia", triple pack

genuine wood veneer, light colouring (similar to oak), not dishwasher-safe

item	w x d x h in cm	PU
8731	30x20x6 (1st bridge)	1 set
	36x20x9 (2nd bridge)	
	42.5x20x12 (3rd bridge)	



buffet bridge "Podia", triple pack

genuine wood veneer, dark (black-brown striped), not dishwasher-safe

item	w x d x h in cm	PU
8730	30x20x6 (1st bridge)	1 set
	36x20x9 (2nd bridge)	
	42.5x20x12 (3rd bridge)	

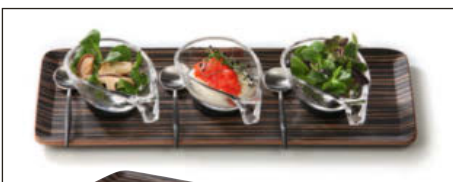

GN tray "Podia"

genuine wood veneer, dark (black-brown striped), not dishwasher-safe

item	l x w in cm	GN	PU
8732.01	32.5x13.2	2/8	6 pcs
8732.02	32.5x17.6	1/3	6 pcs
8732.03	32.5x26.5	1/2	6 pcs

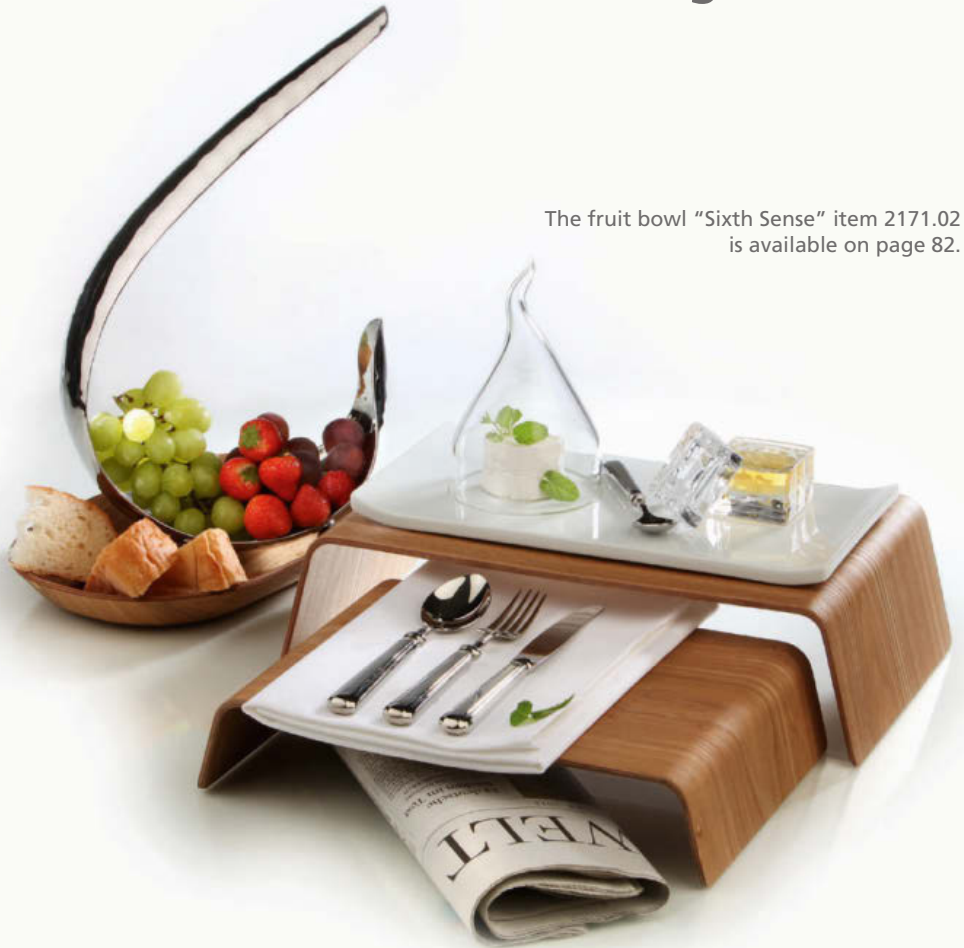

The fruit bowl "Sixth Sense" item 2171.02 is available on page 82.

The buffet bridges and trays of the "Podia" series offer several advantages! They are light but robust, flexibly usable and can be stored in a space-saving way. With its use as a display on the buffet, during coffee break or as a platter for fruit or little somethings in the hotel room - "Podia" offers multiple possibilities for use and flexible handling. Three trays in GN formats (1/2, 1/3 and 2/8) are especially suitable for different miniatures made of porcelain and glass; slide-proof silicone coasters in different styles (page 210) guarantee a good grip during service. All parts of this series consist of form-glued authentic wood veneer, the bridges are available in two types of wood. The light version harmonizes very well with mundane but also with rustic-style furnishing, the version with the black-brown stripes appears exotic and modern.



Hotelcosmetic:
PAM Berlin Slipper & Hotel Supplies -
www.pam-berlin.de

Please note the care instructions: not dishwasher-safe, do not immerse in water!

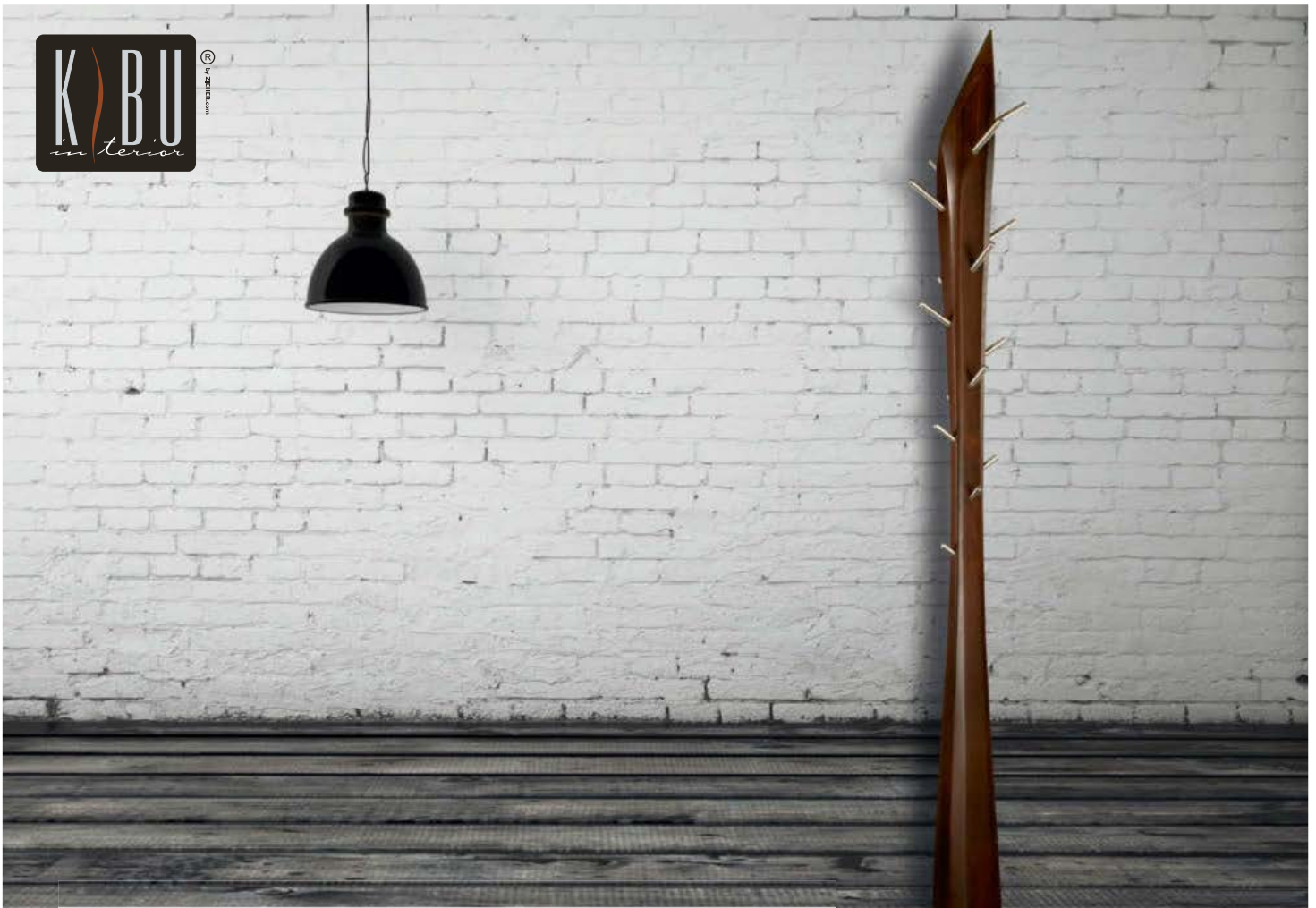

"Slope"



The melamine tray "Slope" is characterised by its unobtrusive shaping and the pleasant feel of the matt and finely structured surface. An elevated corner and the resultant asymmetry award the tray that certain something. Besides the obvious function as a service tray for espresso, cocktails, snacks and more it also performs well in the hotel bathroom or as a decorative trivet in the hotel room.



4596.30



4596.45



coat rack "Kibu"

solid wood, dark stained, foot: stainless steel (brushed), adjustable base for firm positioning on most surfaces

item	Ø in cm	height in cm
7700	60	210



tray "Slope"

melamine, matt, rectangular (oblique), stackable, utility space: approx. 26 cm x 15.5 cm

item	colour	l x w x h in cm	PU
4595.30	black	30x19.5x4.2	3 pcs
4596.30	white	30x19.5x4.2	3 pcs



tray "Slope"

melamine, matt, rectangular (oblique), stackable, utility space: approx. 40 cm x 24 cm

item	colour	l x w x h in cm	PU
4595.45	black	45x29x4.2	2 pcs
4596.45	white	45x29x4.2	2 pcs



Cutlery

MAO



The dressing jar is available on page 100.



The bowls made of hammered stainless steel are available on page 84, the glass trays on page 276.



servers "Mao"

stainless steel 18/10, with black handles of resin, dishwasher-safe

item	version	length in cm
0493.21	salad set	28
0493.30	serving fork	27.5
0493.31	serving spoon	29
0493.40	soup ladle	30
0493.42	dressing ladle	29
0493.43	sauce ladle	22
0493.46	pie server	28

MAO



The tray made of black china is available on page 260.

"Mao", 18/10

with black handle of resin, dishwasher-safe

item	version	length in cm	PU
0493.01	table spoon	22	12
0493.02	table fork	22	12
0493.037	table knife	23	12
0493.04	dessert spoon	19	12
0493.05	dessert fork	18.5	12
0493.067	dessert knife	19	12
0493.07	tea spoon	13	12
0493.09	espresso spoon	10.5	12
0493.11	cake fork	18	12
0493.25	fish knife	21.5	12
0493.26	fish fork	22	12
0493.66	butter knife	18	12



Please note: sale of cutlery only in complete packing units.

GOA

The sushi set is available on page 183,
the cloche of the "Cuspis" series on page 188.



Spot colours of the handles upon request!

"Goa", 18/10

with black handle of resin, dishwasher-safe

item	version	length in cm	PU
0492.01	table spoon	21	12
0492.02	table fork	21	12
0492.037	table knife	22	12
0492.04	dessert spoon	18	12
0492.05	dessert fork	19	12
0492.067	dessert knife	20	12
0492.07	tea spoon	12	12
0492.09	espresso spoon	10	12.
0492.11	cake fork	17	12
0492.25	fish knife	21.5	12
0492.26	fish fork	19.5	12
0492.27	ice/cocktail spoon	21	12
0492.28	oyster fork	17.5	12
0492.29	lobster fork	22.5	12
0492.30	serving fork	27	1
0492.31	serving spoon	27	1
0492.32	2 sticks + 1 bench	approx. 21.5	1 set
0492.66	butter knife	17	12
0492.789	steak knife	22	12



The logo features the word "ZIEHER" in a bold, sans-serif font. A thin, grey arc is positioned above the letters "I" and "E", partially overlapping them. Below "ZIEHER" is the year "2017" in a similar bold, sans-serif font, with the digits spaced out.

ZIEHER
2017

ADD

"Flora"

- High-quality white china
- In accordance with international standards
- Cups with glazed rims
- Dishwasher-safe

"Saturn"



flat plate

item	Ø in cm	PU
3940.20	20	12 pcs
3940.25	25	12 pcs
3940.27	27	12 pcs
3940.30	30	6 pcs



flat plate

item	Ø in cm	PU
4040.16	16	12 pcs
4040.20	20	12 pcs
4040.26	26	12 pcs
4040.28	28	6 pcs
4040.30	30	6 pcs



deep plate

item	Ø in cm	PU
3941	22	12 pcs



deep plate

item	Ø in cm	PU
4041.22	22	12 pcs
4041.30	30	6 pcs



coffee cup

stackable

item	version	PU
3942.O	cup / 0.18 l	12 pcs
3942.U	saucer / Ø 14.8 cm	12 pcs



coffee cup

stackable

item	version	PU
4042.O	cup / 0.18 l	12 pcs
4042.U	saucer / Ø 14.7 cm	12 pcs



salad bowl

item	Ø in cm	height in cm	PU
3946.14	14	4.6	12 pcs



salad bowl

item	Ø in cm	height in cm	PU
4046.15	15	4.4	12 pcs



soup bowl

stackable

item	version	PU
3945.O	cup / 0.27 l	12 pcs
3945.U	saucer / Ø 16 cm	12 pcs



pasta plate
white china

item	Ø in cm	PU
38281	26	6 pcs
38282	30	6 pcs



salt & pepper shaker
stainless steel and glass

item	l x w x h in cm	PU
2050	4x4x10	2 parts



salt shaker & pepper mill

acrylic glass, square, set without fillings, ceramic grinder, 5-years guarantee on the grinder

item	height in cm
2777	16.5



salt shaker & pepper mill

acrylic glass, "Economy", hexagonal, set without fillings, robust, durable, the low-priced alternative, 5-years guarantee on the grinder

item	height in cm
2770	16.5



salt & pepper mill set

acrylic glass, in gift box, without fillings, 5-years guarantee on the grinder

item	height in cm	PU
2771	14.5	2 parts



gas blowlamp

for butane gas cartridge item 2304.04, one-touch automatic ignition (piezo electric), heat adjustable, e.g. for flambéing and sugarcoating of foods

item	height in cm
2304.03	15



butane gas cartridge

for gas blowlamp item 2304.03, weight: 220 g

item	content in ml	PU
2304.04	210	4 pcs



CD fuel

ethanol, box with 72 cans, burning time 3.5 - 4 hours per can

item	content in g	PU
2309.72	200	72 cans



granite sand

for use with chafing dishes, approx. 2.5 kg content

item	colour
2505.R	red
2505.W	white/gray



waiter's wallet

black, 5 pockets, 1 of them with zip, 1 pocket for coins and 1 for notepad

item	material	l x w in cm
0853	calf leather, with eyelet	18.5x10
0853.K	leatherette	18.5x10

waiter's wallet

thick calf leather, black, 5 pockets (graduating) for bills, 1 of them with zip, 1 large for coins, outside pocket for notepad

item	l x w in cm
0823	17x11

waiter's wallet

black calf leather, 7 pockets for bills, 1 of them with zip, 1 large pocket for coins, eyelet for till-key chain fastening

item	l x w in cm
0840	19.5x10



holster for waiter's wallet

calf leather, black, 1 pocket for wallet, 1 for notepad

item	w x h in cm
0853R	12x27

holster for waiter's wallet

calf leather, black, 1 extra pocket each for notepad and pen

item	w x h in cm
0855	13.5x22.5

bill folder

folder in black nappa leather, silver edges

item	l x w in cm
0870	23.5x13



liquid chalk marker

white

item	font width in mm	PU
9639.03	15	3 pcs
9640.05	5	5 pcs



liquid chalk marker

3 colours: blue, yellow, red

item	font width in mm	PU
9641.01	15	3 pcs







liquid chalk marker





5 colours: blue, yellow, green, orange, pink









item	font width in mm	PU
9640.F5	5	5 pcs

Quick-Finder - list of items in ascending order

Item	Description	Page	Item	Description	Page	Item	Description	Page
0405.1288	"Europa", 18/10, mini fork	240	1939.02	skewer, 18/10	98, 138, 240, 242	2168.15	fruit/bread basket, 18/10	94
0405.1388	"Europa", 18/10, mini fork, long	240	1939.03	small skewer, 18/0	163, 240, 243	2169	bowl "Wings", 18/10	80, 83
0492.01	"Goa", 18/10, table spoon	138, 164, 300	1939.04	small skewer, 18/0	163, 240, 243	2169.C	bowl "Wings", 18/10, copper	80, 83
0492.02	"Goa", 18/10, table fork	300	2022	buffet etagere "Choice", 18/10	118	2169.G	bowl "Wings", 18/10, golden	80, 83
0492.037	"Goa", 18/10, table knife	300	2023	rail "Move", 18/10	120	2169.01	bowl "Wings", 18/10	83
0492.04	"Goa", 18/10, dessert spoon	164, 300	2025.26	stand f. small bowls "TriBo", 18/10	119	2169.02	bowl "Wings", 18/10	83
0492.05	"Goa", 18/10, dessert fork	300	2025.35	stand f. small bowls "TriBo", 18/10	119	2170	XXL bowl, 18/10	89
0492.067	"Goa", 18/10, dessert knife	300	2050	salt & pepper shaker	303	2171	bowl/tray "Sixth Sense", 18/10	82
0492.07	"Goa", 18/10, tea spoon	164, 165, 300	2056	cruet stand, 18/10	261	2171.01	bowl/tray "Sixth Sense", 18/10	82
0492.09	"Goa", 18/10, espresso spoon	240, 300	2056.01	cruet stand, 18/10	261	2171.02	bowl/tray "Sixth Sense", 18/10	82
0492.11	"Goa", 18/10, cake fork	300	2056.02	cruet stand, 18/10	261	2171.03	bowl/tray "Sixth Sense", 18/10	80, 82
0492.25	"Goa", 18/10, fish knife	300	2057	tray for inserts, 18/10	261, 272	2171.03C	bowl/tray "Sixth Sense", 18/10, copper	80, 82
0492.26	"Goa", 18/10, fish fork	300	2058	Ménage-à-trois, 18/10	265	2171.03G	bowl/tray "Sixth Sense", 18/10, golden	80, 82
0492.27	"Goa", 18/10, ice/cocktail spoon	300	2101.17	tray, 18/10	93, 271	2172	spoon rest, 18/10	99
0492.28	"Goa", 18/10, oister fork	300	2103.03PB	☞ etagere, 18/10	93, 271	2174	bowl, 18/10	94
0492.29	"Goa", 18/10, lobster fork	300	2105.03	etagere, 18/10	93, 271	2176	dressing jar, 18/10	86, 99
0492.30	"Goa", 18/10, serving fork	100, 300	2105.04	etagere, 18/10	93, 271	2177.10	buffet stand "Skyline", 18/10	8
0492.31	"Goa", 18/10, serving spoon	100, 300	2106.04PB	☞ etagere, 18/10	92, 270	2177.10C	buffet stand "Skyline", 18/10, copper	9
0492.32	"Goa", 18/10, 2 sticks + 1 bench	300	2107.03	etagere, 18/10	92, 270	2177.10G	buffet stand "Skyline", 18/10, golden	9
0492.66	"Goa", 18/10, butter knife	300	2107.04	etagere, 18/10	92, 270	2177.22	buffet stand "Skyline", 18/10	8
0492.789	"Goa", 18/10, steak knife	300	2108.14	buffet stand, 18/10	95	2177.22C	buffet stand "Skyline", 18/10, copper	9
0493.01	"Mao", 18/10, table spoon	164, 299	2108.19	buffet stand, 18/10	95	2177.22G	buffet stand "Skyline", 18/10, golden	9
0493.02	"Mao", 18/10, table fork	299	2108.25	buffet stand, 18/10	95	2177.34	buffet stand "Skyline", 18/10	8
0493.037	"Mao", 18/10, table knife	299	2109.09	bowl "Loop", 18/10	83	2177.34C	buffet stand "Skyline", 18/10, copper	9
0493.04	"Mao", 18/10, dessert spoon	164, 299	2109.PB	☞ bowl "Loop", 18/10	83	2177.34G	buffet stand "Skyline", 18/10, golden	9
0493.05	"Mao", 18/10, dessert fork	299	2110	buffet etagere, 18/10	91, 269	2177.58	buffet stand "Skyline", 18/10	8
0493.067	"Mao", 18/10, dessert knife	299	2110.01	tray with feet, 18/10	91, 269	2177.58C	buffet stand "Skyline", 18/10, copper	9
0493.07	"Mao", 18/10, tea spoon	164, 299	2112	bowl/tray, 18/10	82	2177.58G	buffet stand "Skyline", 18/10, golden	9
0493.09	"Mao", 18/10, espresso spoon	240, 299	2115	tongs holder, 18/10	99	2178.23	fruit/bread basket "Skyline", 18/10	10
0493.11	"Mao", 18/10, cake fork	299	2116.41	bowl, 18/10	80, 88	2179.10	fruit/bread basket "Skyline", 18/10	10
0493.21	"Mao", 18/10, salad servers, 2 parts	100, 298	2116.41C	bowl, copper	80, 88	2179.22	fruit/bread basket "Skyline", 18/10	10
0493.25	"Mao", 18/10, fish knife	299	2116.41G	bowl, golden	80, 88	2179.34	fruit/bread basket "Skyline", 18/10	10
0493.26	"Mao", 18/10, fish fork	299	2116.71	bowl, 18/10	80, 88	2180	etagere, 18/10	84
0493.30	"Mao", 18/10, serving fork	100, 298	2116.71C	bowl, copper	80, 88	2180.09	bowl, 18/10	84, 169, 238
0493.31	"Mao", 18/10, serving spoon	100, 298	2116.71G	bowl, golden	80, 88	2180.13	bowl, 18/10	84, 169, 238
0493.40	"Mao", 18/10, soup ladle	100, 298	2117	bowl, 18/10	87	2180.22	bowl, 18/10	84
0493.42	"Mao", 18/10, dressing ladle	100, 298	2118	plate, 18/10	90	2180.22PB	☞ bowl, 18/10	84
0493.43	"Mao", 18/10, sauce ladle	100, 298	2119	buffet etagere, 18/10	96	2180.30	bowl, 18/10	84
0493.46	"Mao", 18/10, pie server	100, 298	2119.01	tray with feet, 18/10	96	2180.30PB	☞ bowl, 18/10	84
0493.66	"Mao", 18/10, butter knife	299	2119.02	buffet etagere, 18/10	96	2180.40	bowl, 18/10	84
0823	waiter's wallet	304	2121.22	bread/pastry bowl, 18/10	90	2181.14	bowl, 18/10	90
0840	waiter's wallet	304	2122	buffet bowl, 18/10	87	2181.17	bowl, 18/10	90
0853	waiter's wallet	304	2127	tray, 18/10	90	2181.21	bowl, 18/10	90
0853.K	waiter's wallet	304	2128	buffet tray, 18/10	87	2181.24	bowl, 18/10	90
0853R	holster for waiter's wallet	304	2131	bread basket, 18/10	90	2182.09	bowl, 18/10	85, 238
0855	holster for waiter's wallet	304	2132	buffet bowl "Lotus", 18/10	95	2182.13	bowl, 18/10	85, 238
0870	bill folder	304	2133.12	bread/pastry bowl, 18/10	90, 238	2182.22	bowl, 18/10	85
1501	cork	139, 224	2133.19	bread/pastry bowl, 18/10	90	2182.30	bowl, 18/10	85
1502	cork	278	2136	pastry tray, 18/10	91, 269	2183	bowl, 18/10	84
1668.01	buffet platter, black glass	58	2138	ice cube tongs, 18/10	80, 99, 246	2184	bowl, 18/10	95
1668.03	buffet platter, black glass	58, 108, 256, 284	2138.C	ice cube tongs, 18/10, copper	80, 99, 246	2186	tray, 18/10	90
1668.04	buffet platter, black glass	58	2138.G	ice cube tongs, 18/10, golden	80, 99, 246	2187	etagere, 18/10	85, 239, 273
1668.05	buffet platter, black glass	58	2139	serving tongs, 18/10	99	2188.14	tray, 18/10	192, 193, 273
1668.06	buffet platter, black glass	58, 199	2140	serving tongs, 18/10	80, 99	2188.18	tray, 18/10	273
1668.08	buffet platter, black glass	24, 58, 97	2140.C	serving tongs, 18/10, copper	80, 99	2188.22	tray, 18/10	273
1668.09	buffet platter, black glass	58	2140.G	Servierzange, 18/10, golden	80, 99	2188.27	tray, 18/10	273
1668.10	buffet platter, black glass	58, 180, 199	2141.01	buffet stand, 18/10	94	2189	etagere/pastry stand, 18/10	273
1668.11	buffet platter, black glass	58	2141.02	buffet stand, 18/10	94	2189.PB	☞ etagere/pastry stand, 18/10	273
1668.12	buffet platter, black glass	58, 96	2141.03	buffet stand, 18/10	94	2190	toast rack, 18/10	91, 269
1668.14	buffet platter, black glass	58	2149.07	bowl, 18/10	90, 238	2191.03	jam tray, 18/10	238, 272
1668.15	buffet platter, black glass	58	2153	bowl, 18/10	90, 238	2191.04	jam tray, 18/10	238, 272
1669.33	dinner plate, black glass	58, 114, 195, 199, 250	2153.01	bowl, 18/10	90, 239	2193	buffet etagere, 18/10	97
1669.53	buffet platter, black glass	58	2154	spoon rest, 18/10	99	2193.01	tray w. feet, 18/10	25, 97
1670.01	buffet platter, white glass	59	2155	bowl, 18/10	90, 238	2193.02	buffet etagere, 18/10	97
1670.03	buffet platter, white glass	59, 108, 256, 284	2155.01	bowl, 18/10	90, 238	2194.03	food display, 18/10	268
1670.04	buffet platter, white glass	59	2159.16	bowl, 18/10	85, 239	2194.06	food display, 18/10	268
1670.06	buffet platter, white glass	59, 199	2159.16PB	☞ bowl, 18/10	85, 239	2197	etagere, 18/10	86
1670.08	buffet platter, white glass	24, 59, 97	2159.20	bowl, 18/10	85, 239	2198	etagere, 18/10	87
1670.09	buffet platter, white glass	59	2159.20PB	☞ bowl, 18/10	85, 239	2198.PB	☞ etagere, 18/10	87
1670.10	buffet platter, white glass	59, 180, 199	2160.66	sushi tray "Longtray", 18/10	91	2199.30	bowl, 18/10	86
1670.12	buffet platter, white glass	59, 96	2160.90	sushi tray "Longtray", 18/10	91	2199.35	bowl, 18/10	86
1670.14	buffet platter, white glass	59	2161	dinner plate, 18/10	90, 195, 198	2199.40	bowl, 18/10	86
1670.15	buffet platter, white glass	59	2163	champagne bowl, 18/10	80, 88	2199.50	bowl, 18/10	86
1671.33	dinner plate, white glass	59, 71, 114, 195, 199, 250	2163.C	champagne bowl, 18/10, copper	80, 88	2200.PB	XXL bowl, incl. illumination, 18/10	89
1671.53	buffet platter, white glass	59	2163.G	champagne bowl, 18/10, golden	80, 88	2260.16	bowl "Shine", satined, 18/10	72, 111
1936	espresso spoon "Spade", 18/10	240	2167.15	holder coil shape, 18/10	98	2260.20	bowl "Shine", satined, 18/10	72
1938	party spoon, 18/10	138, 164, 240	2167.20	holder coil shape, 18/10	98	2260.24	bowl "Shine", satined, 18/10	72
1938.01	party spoon, 18/10	138, 164, 240	2167.25	holder coil shape, 18/10	98	2261.16	bowl "Shine", ivory, 18/10	72, 111
1939.01	skewer, 18/10	98, 138, 240, 242	2167.30	holder coil shape, 18/10	98	2261.16PB	☞ bowl "Shine", ivory, 18/10	72

Item	Description	Page
2261.20	bowl "Shine", ivory, 18/10	72
2261.20PB	 bowl "Shine", ivory, 18/10	72
2261.24	bowl "Shine", ivory, 18/10	72
2261.24PB	 bowl "Shine", ivory, 18/10	72
2262.16	bowl "Shine", taupe, 18/10	72, 111
2262.20	bowl "Shine", taupe, 18/10	72
2262.24	bowl "Shine", taupe, 18/10	72
2304.03	gas blowlamp	303
2304.04	butane gas cartridge	303
2309.72	CD fuel	303
2310	bowl/basket "Reef", pewter	66, 294
2311	bowl/basket "Reef", pewter	66, 294
2312.01	bowl/basket "Reef", pewter	66, 294
2312.02	bowl/basket "Reef", pewter	66, 294
2313.01	bowl/basket "Reef", pewter	66, 294
2313.02	bowl/basket "Reef", pewter	66, 294
2332	bowl/basket "Reef", pewter	67
2333	bowl/basket "Reef", pewter	67
2334	bowl/basket "Reef", pewter	67
2335	bowl/basket "Reef", pewter	67
2336	bowl/basket "Reef", pewter	67
2336.PB	 bowl/basket "Reef", pewter	67
2370.23	tray "Artisan", 18/10	79
2370.28	tray "Artisan", 18/10	79
2370.33	tray "Artisan", 18/10	79
2370.39	tray "Artisan", 18/10	79
2371.07	bowl "Artisan", 18/10	78, 238
2371.11	bowl "Artisan", 18/10	78, 238
2371.14	bowl "Artisan", 18/10	78
2372	bread/pastry bowl "Artisan", 18/10	78
2373	bread/pastry bowl "Artisan", 18/10	78
2374.24	tray "Artisan", 18/10	79
2375.33	dinner plate "Artisan", 18/10	78, 198
2376	etagere "Artisan", 18/10	79
2380.07	bowl/display "Fakir", brass	68, 257
2380.12	bowl/display "Fakir", brass	68, 257
2380.15	bowl/display "Fakir", brass	68, 257
2380.18	bowl/display "Fakir", brass	68, 257
2381.38	bowl "Roots", brass	68, 293
2381.38PB	 bowl "Roots", brass	68, 293
2382.38	bowl "Matrix", brass	68, 293
2505.R	granite sand, red	303
2505.W	granite sand, white/grey	303
2543.30	dinner plate, slate	53, 198
2544.30	dinner plate, slate	53, 198
2770	salt shaker & pepper mill	303
2771	salt & pepper mill set	303
2777	salt shaker & pepper mill	303
2779	salt/pepper mill set	263
3461	card holder, 18/10	100
3466.01	cruet stand	266
3466.02	cruet stand	266
3467.01	tray f. inserts up to 5x5 cm, 18/10	261
3467.02	tray f. inserts up to 5x5 cm, 18/10	261
3468.01	cruet stand	267, 278
3468.02	cruet stand	267, 278
3469.02	tray f. inserts up to 7x7 cm, , 18/10	261
38281	pasta plate, china	303
38282	pasta plate, china	303
3844	mini bowl, china	226, 263
3845	mini bowl, china	139, 226, 263
3845.01	mini bowl, china	226, 263
3849	creamer, china	226, 263
3853	mini bowl, china	139, 226, 264
3854	mini bowl, china	226, 264
3854.01	mini bowl, china	226, 264
3855	mini bowl, china	226, 263
3855.01	mini bowl, china	214, 226, 263
3857	saucer, china	162, 191, 194, 233
3858	mini bowl, china	154, 226
3859	mini bowl, china	154, 226
3912	dip bowl f. olive oil "Twist", china	139, 234
3939.25	platter "Catering", china	162
3939.30	platter "Catering", china	162
3939.35	platter "Catering", china	162
3940.20	plate "Flora", china	302
3940.25	plate "Flora", china	302
3940.27	plate "Flora", china	302
3940.30	plate "Flora", china	302
3941	plate "Flora", china	302
3942.O	coffee cup "Flora", china	302



Item	Description	Page
3942.U	saucer "Flora", china	302
3945.O	soup bowl "Flora", china	302
3945.U	saucer "Flora", china	302
3946.14	salad bowl "Flora", china	302
3954.08	coup plate "Catering", china	162, 233, 270
3954.15	coup plate "Catering", china	162
3954.19	coup plate "Catering", china	162
3954.21	coup plate "Catering", china	162
3954.23	coup plate "Catering", china	162
3954.25	coup plate "Catering", china	162
3954.28	coup plate "Catering", china	162
3955.16	plate "Catering", china	162
3955.20	plate "Catering", china	162
3955.26	plate "Catering", china	162
3955.27	plate "Catering", china	162
3955.30	plate "Catering", china	162
3956.23	plate "Catering", china	162
3958.O	coffee cup "Catering", china	162
3958.U	saucer "Catering", china	162
3960.O	soup bowl "Catering", china	162
3960.U	saucer "Catering", china	162
3962.06	tapas bowl "Catering", china	162, 233
3963.14	salad bowl "Catering", china	162
3963.16	salad bowl "Catering", china	162
3963.19	salad bowl "Catering", china	162
3963.23	salad bowl "Catering", china	162
3971.30	plate "Catering", deep, china	162
3972.32	dinner plate "Catering", china	162
3977	egg cup "Catering", china	162, 233, 266
4032.G	test tube	139, 224
4040.16	plate "Saturn", china	302
4040.20	plate "Saturn", china	302
4040.26	plate "Saturn", china	302
4040.28	plate "Saturn", china	302
4040.30	plate "Saturn", china	302
4041.22	plate "Saturn", china	302
4041.30	plate "Saturn", china	302
4042.O	coffee cup "Saturn", china	302
4042.U	saucer "Saturn", china	302
4046.15	salad bowl "Saturn", china	302
4072.M	mini platter, china	139, 235
4076	table display, china	100
4081.12	bowl, china	125, 232, 275, 277
4082	mini bowl, china	235
4093	small sauce boat, china	235
4102	amuse gueule bowl, china	235
4230.11	mini bowl "Spobo", china	164, 232, 277
4230.14	fruit/dessert bowl "Spobo", china	164
4230.14PB	 fruit/dessert bowl "Spobo", china	164
4230.18	soup bowl "Spobo", china	164
4230.18PB	 soup bowl "Spobo", china	164
4231.LO	bowl + platter "Duo", china	166, 232
4231.LU	bowl + platter "Duo", china	166
4231.MO	bowl + platter "Duo", china	166
4231.MU	bowl + platter "Duo", china	166
4231.SO	bowl + platter "Duo", china	166, 232, 277
4240.10	mini plate, china	190, 235, 270
4260.01	tapas spoon, china	137, 235, 240
4260.03	tapas spoon "Modul", china	172, 235, 240
4280.22	plate "Catering de Luxe", china	163
4280.30	plate "Catering de Luxe", china	163
4281	bowl "Catering de Luxe", china	111, 119, 163
4281.01	bowl "Catering de Luxe", china	119, 163
4281.02	bowl "Catering de Luxe", china	118, 163
4281.03	bowl "Catering de Luxe", china	118, 163
4281.04	bowl "Catering de Luxe", china	163
4324.11	mini plate, china	190, 232, 270
4326.11	small bowl, china	190, 232, 277
4359	fondue set, 2 parts, china	163
4375.01PB	 bowl "Cave", china	173, 235
4380	plate "Modul", china	136, 172, 236
4381	bowl "Modul", china	136, 172, 236
4383	plate "Modul", china	137, 172, 236
4384	bowl "Modul", china	136, 172, 236
4385.22	plate "Modul", china	136, 173
4385.27	plate "Modul", china	136, 173
4386	plateau plate "DressCoat", china	151, 234
4386.PB	 plateau plate "DressCoat", china	151
4386.01	plateau plate "DressCoat", china	150
4386.02	plateau plate "DressCoat", china	150, 234
4386.02B	plateau plate "DressCoat", china	150, 234, 282





Item	Description	Page
4387	plateau plate "DressCoat", china	151
4387.PB	 plateau plate "DressCoat", china	151
4388	plateau plate "DressCoat", china	151
4388.PB	 plateau plate "DressCoat", china	151
4389.09	plateau plate "Cuspis", china	144, 188, 213
4389.11	plateau plate "Cuspis", china	144, 188, 213
4389.25PB	 plateau plate "Cuspis", china	144, 188
4397	wind light, biscuit	192, 282
4398	saucer, biscuit	192, 233, 282
4399.PB	 wind light w. saucer, biscuit	282
4451	tray f. inserts up to 5x5 cm, china	184, 260
4455	tray f. inserts up to 7x7 cm, china	184, 260
4458	dressing/jam jar, china	100
4461.01	porcelain pillow "Donna"	142, 234
4461.01PB	 porcelain pillow "Donna"	142
4461.02	porcelain pillow "Donna"	142
4461.02PB	 porcelain pillow "Donna"	142
4461.03	porcelain pillow "Donna"	142, 234
4463	platter "Move", china	120, 236
4464	bowl "Move", flat, china	120, 236
4465	bowl "Move", deep, china	120, 236
4489	creamer, china	124, 162, 233, 266, 275
4490	miniature, white	98, 124, 162, 214, 233, 266, 275
4490.01	miniature, black	98, 124, 162, 214, 233, 266, 275
4491	dinner plate "SelectionA.", china	168
4492	dinner plate "SelectionA.", china	168
4493.19	plate "SelectionA.", china	168
4493.24	plate "SelectionA.", china	168, 192
4495	plate "SelectionA.", china	168
4498	bowl, china	125, 233, 265, 267, 275
4499	bowl "Catering"	125, 162, 233, 265, 267, 275
4500	bowl "Catering"	125, 162, 233, 265, 275
4501	platter "Collina", china	157
4501.PB	 platter "Collina", china	157
4502	platter "Collina", china	157
4503	platter "Collina", china	157
4504	platter "Collina", china	157
4504.PB	 platter "Collina", china	157
4505	plate/platter "Velo", china	148
4505.01	plate/platter "Velo", china	148
4506	plate/platter "Dots", china	154
4520.28	plate "Plat de Luxe", china	158
4520.32	plate "Plat de Luxe", china	158, 200
4520.32D1	plate "Plat de Luxe", china	158, 200
4520.32D2	plate "Plat de Luxe", china	158, 200
4521.26	plate "Plat de Luxe", china	158
4563	china ball "oro79"	160
4564.12	platter/plate "oro79", china	160
4564.19	platter/plate "oro79", china	160
4564.26	platter/plate "oro79", china	160
4565.35	platter/plate "oro79", china	160
4566.24	plate "Rough!", china	146
4566.27	plate "Rough!", china	146
4567.24	plate "Rough!", china	147
4567.27	plate "Rough!", china	147
4568.23	platter/plate "Rough!", china	146
4569.12	platter/plate "Rough!", china	146
4569.23	platter/plate "Rough!", china	146
4569.27	platter/plate "Rough!", china	146
4570.23	platter/plate "Rough!", china	147
4571.12	platter/plate "Rough!", china	147
4571.23	platter/plate "Rough!", china	147
4571.27	platter/plate "Rough!", china	147
4572.36	platter/plate "Rough!", china	146
4573.36	platter/plate "Rough!", china	147
4581	base tray "Modul", melamine	134
4582	base tray "Modul", melamine	24, 134
4583	base tray "Modul", melamine	134
4584	bridge "Modul", melamine	122, 134
4585	spoon bridge "Modul", melamine	122, 134, 138, 274
4586	tray, melamine	124, 274
4587	1/3 GN-tray, melamine	122, 274
4588	1/2 GN-tray, melamine	122, 274
4589	1/8 GN-tray, melamine	122, 274
4590	2/8 GN-tray, melamine	124, 274
4591	cutlery/napkin box, melamine	115, 126, 138
4592	stacking frame 1/1 GN, melamine	122
4593	tray, melamine	125, 274
4594	cutlery box, melamine	115, 126
4595.30	tray "Slope", melamine	127, 259, 296
4595.45	tray "Slope", melamine	127, 259, 296







Item	Description	Page
4595.45PB	☞ tray "Slope", melamine	127, 259
4596.30	tray "Slope", melamine	127, 259, 296
4596.45	tray "Slope", melamine	127, 259, 296
4596.45PB	☞ tray "Slope", melamine	127, 259
4600.28	bowl "Pueblo", stone ware	70, 152
4600.35	bowl "Pueblo", stone ware	70, 152
4600.40	bowl "Pueblo", stone ware	70, 152
4600.45	bowl "Pueblo", stone ware	70, 152
4601.22	bowl "Pueblo", stone ware	70, 152
4601.27	bowl "Pueblo", stone ware	70, 152
4601.33	bowl "Pueblo", stone ware	70, 152
4602.12	bowl "Pueblo", stone ware	152, 234
4603.12	bowl "Pueblo", stone ware	152, 234
4604.01	miniature "Pueblo", stone ware	152, 234
4604.02	miniature "Pueblo", stone ware	152, 234
4605.18	plate "Pueblo", stone ware	152
4605.23	plate "Pueblo", stone ware	152
4605.27	plate "Pueblo", stone ware	152
4606.10	miniature plate, stone ware	233, 270
4606.17	plate, stone ware	233, 271
4607.10	miniature plate, stone ware	233, 270
4607.17	plate, stone ware	233, 271
4660.01	non-slip mat "Modul", silicone	130
4660.02	non-slip mat "Modul", silicone	130
4660.03	non-slip mat "Modul", silicone	130
4661.05S	saucer, silicone	210
4661.05W	saucer, silicone	210
4661.07S	saucer, silicone	210
4661.07W	saucer, silicone	210
4680.S	test tube holder, silicone	139, 214, 224
4680.W	test tube holder, silicone	139, 214, 224
4681.S	ring "SelectionA."	23, 169, 185, 194, 230
4681.W	ring "SelectionA."	23, 169, 185, 194, 230
4682.S	ring "SelectionA.", silicone	169, 209
4682.W	ring "SelectionA.", silicone	169, 209
4683	silicone sleeve	96
4684	silicone sleeve	9, 16
4700	saucer "Solid", walnut	193, 252
4700.01	saucer "Solid", walnut	191, 252
4700.02	saucer "Solid", walnut	192, 252
4701	tray "Solid", walnut	250
4701.G	glass insert/saucer	250
4702	tray "Solid", walnut	250, 288
4702.G	glass insert/saucer	250, 288
4703	box "Solid" f. inserts , walnut	249, 262
4704	box "Solid" f. inserts , walnut	249, 262
4705	box "Solid", walnut	249
4706	serving tray "Solid", walnut	112, 256, 284
4707.PB	☞ serving tray "Solid", walnut	108, 256, 284
4708	tray "Solid" f. inserts , walnut	250, 262
4708.G	glass insert/saucer	250
4709	tray "Solid", walnut	250
4709.G	glass insert/saucer	250
4710	serving tray "Solid", walnut	114, 250
4711.18	bowl "Solid", walnut	114, 250
4711.24	bowl "Solid", walnut	114, 250
4711.30	bowl "Solid", walnut	114, 250
4712	box "Solid" f. inserts, walnut	249, 262
4713	box/tray "Solid", walnut	112, 256, 288
4714	tealight holder "Solid", walnut	280
4715	tealight holder "Solid", walnut	280
4716	tealight holder "Solid", walnut	280
4717	tealight holder "Solid", walnut	280
4718	tray stand "Solid", walnut	106
4719	tray "Solid", walnut	249, 262
4719.01	tray "Solid", walnut	249, 262
4720	cutlery box "Solid", walnut	115, 248
4721	base tray "Modul", walnut	132
4722	base tray "Modul", walnut	24, 132
4723	base tray "Modul", walnut	132
4724	bridge "Modul", walnut	132
4725	spoon bridge "Modul", walnut	132
4730	bridge "Solid", walnut	111
4731	bridge "Solid", walnut	111
4732.PB	☞ cutting board "Solid", walnut	110
4733	bread cutting board "Solid", walnut	110
4733.R	replacement grate "Solid", walnut	110
4735	roomservice tray "Solid", walnut	113, 255, 287
4734.01	saucer "Solid", walnut	117, 189, 253
4734.02	saucer "Solid", walnut	117, 189, 253
4734.03	saucer "Solid", walnut	117, 189, 253

Item	Description	Page
4734.04	saucer "Solid", walnut	117, 189, 253
4736	walnut connector "Squareline"	16
4737	chocolate/truffle box "Solid"	246
4738	chocolate/truffle box "Solid"	246
4740	serving tray "Solid", walnut	109, 256
4742	tray insert "Solid", walnut	108
4741	grid insert "Solid", walnut	109
4743	tray insert "Solid", walnut	108
4744	cutlery insert "Solid", walnut	109
4745	tray insert "Solid", walnut	109
4746	tray stand "Solid", walnut	106
4747	connector piece "Solid", walnut	106
4748	tray stand/side table "Solid"	286
4749	ham holder "Solid", walnut	111
4760	bread basket/bowl "Solid", walnut	114, 250
4761	bread basket/bowl "Solid", walnut	114, 250
4762.18	storage/presentation box "Solid"	244, 288, 289
4762.18G	glass lid	244, 289
4762.24	storage/presentation box "Solid", walnut	288
4762.30	storage/presentation box "Solid", walnut	288
4763.01S	insert f. chocolate "Solid", black	244, 289
4763.01W	insert f. chocolate "Solid", white	244, 289
4763.02S	insert f. cigars "Solid", black	244, 289
4763.02W	insert f. cigars "Solid", white	244, 289
4763.03S	insert f. coffee capsules "Solid"	244, 289
4763.03W	insert f. coffee capsules "Solid"	244, 289
4763.04W	insert/platter "Solid", white	244, 289
4766	cutlery/napkin box "Solid"	248, 284
4767.12	buffet display "Solid", walnut	41, 115, 132
4767.24	buffet display "Solid", walnut	41, 115, 132
4768.08	buffet display/basket "Mercato", walnut	104
4768.12	buffet display-Korb "Mercato", walnut	104
4768.16	buffet display-Korb "Mercato", walnut	104
4770.24	bread basket "Solid", walnut	251
4771.24	bread basket "Solid", walnut	251
4772.33PB	☞ wooden pillow "Donna", walnut	143,
4773.PB	☞ bed tray, walnut	113, 255, 287
4774.31PB	☞ cutting board "Connect!"	112, 254
4775.44PB	☞ cutting board "Connect!"	112, 254
4810.01	bowl, transparent glass, white	75
4810.02	bowl, transparent glass, white	75
4810.03	bowl, transparent glass, white	75
4811.01	bowl, transparent glass, black	75
4811.02	bowl, transparent glass, black	75
4811.03	bowl, transparent glass, black	75
4812.08	glass platter	227
4812.10	glass platter	227
4813.28	glass bowl "Duplex"	73
4813.35	glass bowl "Duplex"	73
4813.46	glass bowl "Duplex"	73
4850	glass cloche	116,195, 253
4851	glass cloche	116,195, 253
4852	glass cloche	116,195, 253
4853	glass cloche	194
4854.01	glass stand	194
4854.02	glass stand	194
4854.03	glass stand	194
4857.10	glass bowl, white	179
4857.14	glass bowl, white	179
4857.16	glass bowl, white	179
4858.10	glass bowl, black	179
4858.14	glass bowl, black	179
4858.16	glass bowl, black	179
4859.07	mini glass bowl, white	169, 179, 180, 230
4860.07	mini glass bowl, black	169, 179, 180, 230
4880.18	glass cloche	117,189, 253
4880.22	glass cloche	117,189, 253
4880.26	glass cloche	117,189, 253
4880.30	glass cloche	117,189, 253
4881.26	wine cooler, glass	23
4882.22PB	☞ cloche w. wooden saucer	117, 189, 253
4882.30PB	☞ cloche w. wooden saucer	117, 189, 253
4883	decanter "Eddy"	209
4884.PB	☞ decanter "Eddy" w. ring	209
4901.01	glass miniature	222
4901.02	glass miniature	222
4901.03	glass miniature	98, 102, 222, 266
4903	glass miniature	124, 222, 275
4907	glass cup	125, 222, 265, 275
4908	long drink glass	222
4910	glass bowl	138, 224

Item	Description	Page
4912	glass miniature "Amuse"	98, 218
4914	glass miniature "Amuse"	218
4914.PB	☞ glass miniature "Amuse"	218
4915	glass miniature "Amuse"	218
4915.PB	☞ glass miniature "Amuse"	218
4916	cloche/bowl "Amuse", glass	191, 216
4917	cloche/bowl "Amuse", glass	193, 216
4918.PB	☞ glass tin "Amuse"	219
4919.PB	☞ glass tin "Amuse"	219
4920	glass tin "Amuse"	219
4920.PB	☞ glass tin "Amuse"	219
4921	glass tin "Amuse"	219
4921.PB	☞ glass tin "Amuse"	219
4922	creamer "Amuse", glass	220
4923	nut bowl "Amuse", glass	220
4923.PB	☞ nut bowl "Amuse", glass	220
4924.01	glass miniature "Amuse"	216
4924.01PB	☞ glass miniature "Amuse"	216
4924.02	glass miniature "Amuse"	216
4924.02PB	☞ glass miniature "Amuse"	216
4925.01	glass cone "Lacuna"	215
4926.01	glass bowl "Lacuna"	215
4930	small bowl, glass	224, 230
4940.08	glass cloche "Cuspis"	144, 188, 213
4940.10	glass cloche "Cuspis"	144, 188, 213
4940.25	glass cloche "Cuspis"	144, 188
4941.01	glass spoon "Cuspis"	212, 240
4942.01	honey spoon "Cuspis", glass	212, 237, 240
4943.08PB	☞ glass cloche w. porcelain saucer	144, 188, 213
4943.10PB	☞ glass cloche w. porcelain saucer	144, 188, 213
4943.25PB	☞ glass cloche w. porcelain saucer	144, 188
4944.PB	☞ honey spoon w. glass rest "Cuspis"	212, 237
4950	ice bucket, glass	186
4950.D	glass lid f. ice bucket	186
4952.05	decanter, glass	186
4952.09	decanter, glass	186
4954.01	small bowl "Halfmoon", glass	223, 265, 277
4954.02	small bowl "Halfmoon", glass	125, 223, 267, 275
4954.03	small bowl "Halfmoon", glass	223
4954.03PB	☞ small bowl "Halfmoon", glass	223
4955	tea set, glass	186
4956.01	bowl, glass	223
4956.02	bowl, glass	119, 223
4956.02PB	☞ bowl, glass	223
4956.03	bowl, glass	223
4956.03PB	☞ bowl, glass	223
4956.04	bowl, glass	223
4956.04PB	☞ bowl, glass	223
4957	bowl "SelectionA.", glass	168, 222
4958	fondue insert, glass	163, 169, 222
4962	cocktail glass	222
4963.01	small bowl, glass	223
4963.02	small bowl, glass	223
4963.03	small bowl, glass	223
4964	small bowl, "Halfmoon", glass	223
4980.08	glass straw	222
4980.12	glass straw	222
4980.16	glass straw	214, 222
4982	glass cloche	102, 193, 252
4982.05	glass cloche	102, 190
4982.06	glass cloche	190
4982.07	glass cloche	190
4982.09	glass cloche	191, 252
4982.11	glass cloche	192, 252
4983	vinegar/oil bottle, glass	279
4984	vinegar/oil bottle, glass	279
4985	vinegar/oil bottle, glass	279
4986	vinegar/oil bottle, glass	279
4987.01	wind light, glass	191, 281
4987.02	wind light, glass	191, 281
4988.01	wind light, glass	192, 281
4988.02	wind light, glass	192, 281
4989	glass tube "Soup Flow"	171, 224
4990.01	glass tube "Sauce Flow"	171, 224
4990.02	glass tube "Sauce Flow"	171, 224
4991.02	wind light, glass	281
4992.02	wind light, glass	281
4993	vinegar/oil bottle, glass	279
4994.02	wind light, glass	281
4995	creamer, glass	220
4999	dinner plate, transparent glass	57, 114, 199, 250

Item	Description	Page
5000	buffet platter, transparent glass	57
5000.B	buffet platter, grey glass	60
5013.46	buffet bowl "Milky", satined glass	76
5014.38	buffet bowl "Milky", satined glass	76
5016.24	glass bowl	182, 192
5020	glass platter "Wave", 1/1 GN	184
5024.45	buffet bowl, glass	76
5025.46	buffet bowl, glass	76
5026.01	glass steps	63
5026.02	glass steps	63
5026.03	glass steps	62
5026.04	glass steps	62
5034	small bowl, glass	237
5034.01	miniature plate, glass	190, 237
5039	small bowl "Drop", glass	237
5039.01	small bowl "Drop", glass	190, 237
5040	small bowl "Drop", glass	237
5049.35	glass bowl	76
5062	glass platter	184
5063	glass platter	76, 184
5063.50	glass platter	76, 184
5064	glass platter	184
5070.01	glass stand	63
5074.01	glass plate "Modul"	137, 172, 236
5074.02	glass plate "Modul"	137, 172, 236
5074.03	glass plate "Modul"	137, 172, 236
5075.40	buffet platter, glass	184
5076.01	glass steps	63
5076.02	glass steps	63
5084	glass platter	184
5088	glass plate "Vario"	184
5099	small bowl, glass	237
5113.01	small bowl, glass	237
5127.32	glass bowl	184
5135.PB	 glass tray w. bowl	166, 178, 277
5137.34	glass plate/bowl	182
5141.26	glass tray	62, 178, 276
5141.34	glass tray	62, 178, 276
5141.50	glass tray	62, 178, 276
5142.34	glass tray	62, 178, 276
5143	glass tray	178, 276
5145	glass tray	178, 190, 276
5147	glass plate	178
5149.32	glass plate "Ribbon", flat	182, 198
5154	glass platter	180, 190
5160.31	glass platter	25, 76
5160.62	glass platter	25, 76
5161.31	glass platter	25, 76
5161.62	glass platter	25, 76
5164	glass bowl	76
5165	glass bowl	76
5166	small glass bowl	66, 237, 294
5167	small bowl/glass rest	212, 237
5168.06	spoon rest/glass miniature	100, 183
5168.14	glass platter/plate	183
5168.25	glass platter/plate	183
5168.30	glass platter/plate	183
5169.31	glass platter/plate	183
5169.38	glass platter/plate	183
5169.41	glass platter/plate	183
5170.PB	 sushi set, glass	181, 183
5210	ashtray f.cigars, glas	100, 230, 283
5239.M	buffet platter, satined glass	56
5240.M	buffet platter, satined glass	49, 56, 89
5241	buffet platter "Curve 90°", transparent	57
5241.B	buffet platter "Curve 90°", grey glass	60
5242	buffet platter "Curve 45°", transparent	57
5242.B	buffet platter "Curve 45°", grey glass	60
5243	buffet platter, transparent glass	24, 57, 97
5243.B	buffet platter, grey glass	24, 60, 97
5243.M	buffet platter, satined glass	24, 56, 97
5244	glass insert "Solid"	68, 193, 252, 257
5244.09	glass insert "Solid"	68, 191, 252, 257
5244.11	glass insert "Solid"	68, 192, 252, 257
5244.17	glass insert "Solid"	68, 117, 189, 253, 257
5244.21	glass insert "Solid"	68, 117, 189, 253, 257
5244.24	glass insert "Solid"	68, 117, 189, 253, 257
5244.28	glass insert "Solid"	68, 117, 189, 253, 257
5254	small bowl, glass	139, 154, 227, 263
5254.01	glass miniature	154, 227, 263
5255	creamer, glass	154, 227, 263

Item	Description	Page
5257	dessert glass	139, 231
5258	small bowl, glass	154, 227, 264
5261.01	buffet stand "U-Turn", glass	40
5261.02	buffet stand "U-Turn", glass	40
5261.03	buffet stand "U-Turn", glass	40
5270	miniature glass	228
5276	glass w. catch	228
5290.01	glass bottle	228
5290.02	glass bottle	11, 124, 228, 275
5295.01	glass bottle	228, 263
5295.02	glass bottle	228, 264
5296.01	glass bottle	228, 263
5296.02	glass bottle	228, 263
5297.01	cork, PE	228, 263
5297.02	cork, PE	228, 263
5308	glass bowl	185
5308.08	glass bowl	185, 231
5308.11	glass bowl	185, 231
5308.11D	glass bowl	185, 231
5308.20	glass bowl	185
5308.26	glass bowl	185
5317	vinegar/oil bottle, glass	278
5329.14	glass bowl	119, 185
5329.21	glass bowl	118, 185
5329.25	glass bowl	118, 185
5330.08	glass bowl	185, 231
5330.20	glass bowl	185
5330.24	glass bowl	185
5330.29	glass platter	185
5331.30	glass platter	185, 231
5338	glass box	154, 227, 264
5338.01	glass miniature	154, 227, 264
5346	bowl	185
5347	caviar cooler, glass	94, 185
5348	vinegar/oil bottle, glass	267, 278
5349.21	pastry/cake stand, glass	116, 195
5349.28	pastry/cake stand, glass	116, 195
5349.33	pastry/cake stand, glass	116, 195
5350.16	glass cloche	116, 195
5350.23	glass cloche	116, 195
5350.27	glass cloche	116, 195
5351	vinegar/oil bottle, glass	267, 278
5352	decanter, glass	11, 186
5360	bowl, glass	74
5360.01	bowl, glass	74
5361	bowl, glass	74
5362	bowl, glass	74
5363	bowl, glass	74, 118
5364	bowl, glass	74, 118
5365	bowl, glass	74
5366	bowl, glass	74
5380	glass	124, 156, 230, 275, 277
5381	glass	124, 156, 230, 275, 277
5405	glass	139, 214, 230, 266
5408.01	glass miniature	230, 272
5408.02	glass miniature	214, 230, 272
5413	glass	139, 230
5415	glass cone	102, 231, 268
5416	creamer, glass	229
5418	small bowl, glass	156, 169, 194, 230
5419.01	small bowl, glass	119, 185
5419.02	small bowl, glass	111, 119, 185
5420	glass miniature	125, 225, 265, 267, 275
5420.01	glass miniature "Milky"	125, 225, 265, 267, 275
5422	small glass bowl	225
5423.01	glass miniature, base	139, 225
5423.02	glass miniature, top	139, 225
5424	butter lard, glass	229
5425	jam/sugar bowl, glass	119, 229
5428.04	jam tray, glass	227, 272
5440	miniature bowl "Spobo", glass	165, 232, 277
5441	bowl "Duo", glass	166, 232, 277
5442	glass miniature	232, 277
5443	glass miniature	232, 270
5444	bowl, glass	125, 232, 275, 277
5445	glass miniature	225
5446.01PB	 glass pillow "Donna"	143, 234, 291
5480.01	 FRESH	206
5480.02	 STRAIGHT	206
5480.03	 INTENSE	206
5480.04	 BALANCED	207

Item	Description	Page
5480.05	 RICH	207
5480.06	 NOSTALGIC	207
5481	 champagne flute "Vaganza", transparent	202
5481.GPB	 champagne flute "Vaganza" golden	202
5481.PPB	 champagne flute "Vaganza" platinum	202
5660	hook and loop strap	103
5700	glass plate/platter	77, 182
5701	glass bowl	77, 182
5702	glass plate/platter	77, 182
5703	buffet bowl, glass	77
5730.18	glass plate, flat	176, 191, 271
5730.23	glass plate, flat	176
5730.26	glass plate, flat	176
5731.19	glass plate, deep	176, 191
5731.23	glass plate, deep	176
5731.28	glass plate, deep	176
5740	glass bottle	228, 263
5741	glass bottle miniature	176, 229
5760.35	dinner plate "Ice", glass	177, 198
5761.33	dinner plate "Ice", glass	177, 198
5762.16	glass platter "Ice"	177
5762.33	glass platter "Ice"	177
5762.40	glass platter "Ice"	177
7000.08	buffet display "Neo", resin	33
7000.16	buffet display "Neo", resin	33
7000.24	buffet display "Neo", resin	33
7001.12	buffet display "Neo", resin	33
7001.24	buffet display "Neo", resin	33
7001.36	buffet display "Neo", resin	33
7005.08	buffet display/ice bucket "Neo", resin	32
7005.16	buffet display/ice bucket "Neo", resin	32
7010.26	wine cooler/cloche, resin	23
7100.16	bread plate "Capiz", shell	175
7100.31	dinner plate "Capiz", shell	175, 201
7100.36	dinner plate "Capiz", shell	175, 201
7103.20	tray "Capiz", shell	174, 257, 292
7103.26	tray "Capiz", shell	174, 257, 292
7106.46	bowl "Capiz", shell	71, 174, 292
7109.46	bowl "Capiz", shell	71
7109.46PB	 bowl "Capiz", shell	71
7112.36	bowl "Capiz", shell	71
7115.36	dinner plate "Capiz", shell	175, 201
7116.36	dinner plate "Capiz", shell	174, 201
7700	coat rack "Kibu", solid wood	296
8002.01	buffet platter "Shabby Chic", laminated plastic	55
8002.02	buffet platter "Shabby Chic", laminated plastic	55
8002.04	buffet platter "Shabby Chic", laminated plastic	55
8002.06	buffet platter "Shabby Chic", laminated plastic	55
8002.08	buffet platter "Shabby Chic", laminated plastic	55
8002.11	buffet platter "Shabby Chic", laminated plastic	55
8002.13	buffet platter "Shabby Chic", laminated plastic	55
8003.01	buffet platter "Industry", laminated plastic	55
8003.02	buffet platter "Industry", laminated plastic	55
8003.04	buffet platter "Industry", laminated plastic	55
8003.06	buffet platter "Industry", laminated plastic	55
8003.08	buffet platter "Industry", laminated plastic	55
8003.11	buffet platter "Industry", laminated plastic	55
8003.13	buffet platter "Industry", laminated plastic	55
8004.01	buffet platter, transparent	57
8004.01B	buffet platter, grey glass	60
8004.01M	buffet platter, satined glass	56
8004.02	buffet platter, transparent	57
8004.02B	buffet platter, grey glass	60
8004.03	buffet platter, transparent	57
8004.03B	buffet platter, grey glass	60
8004.04	buffet platter, transparent	57
8004.04B	buffet platter, grey glass	60
8004.04M	buffet platter, satined glass	56
8004.05	buffet platter, transparent	57
8004.05B	buffet platter, grey glass	60
8004.06	buffet platter, transparent	57
8004.06B	buffet platter, grey glass	60
8004.07	buffet platter, transparent	57, 286
8004.07B	buffet platter, grey glass	60, 286
8005.01	buffet platter, slate	53
8005.02	buffet platter, slate	53
8005.03	buffet platter, slate	53
8005.04	buffet platter, slate	53
8005.05	buffet platter, slate	53
8005.06	buffet platter, slate	53
8005.07	buffet platter, slate	53

Item	Description	Page	Item	Description	Page	Item	Description	Page
8005.08	buffet platter, slate	53	8048	skewer plate, slate	243	8202	wine cooler, fibreglass	10
8005.09	buffet platter, slate	53	8049	skewer plate, slate	243	8203.01	insert, acrylic	11
8005.21	buffet platter, slate	53	8050	skewer plate, slate	243	8203.02	insert, acrylic	11
8006.01	buffet platter, laminated plastic	54	8051	skewer plate, slate	243	8204.01	insert, acrylic	11
8006.02	buffet platter, laminated plastic	54	8052	marble platter	98	8204.02	insert, acrylic	11
8006.04	buffet platter, laminated plastic	54	8053	slate saucer	280	8205.12	buffet display "V12", carbon	44
8006.06	buffet platter, laminated plastic	54	8070.01PB	wine cooler w. stand "Stablo"	22	8205.24	buffet display "V12", carbon	44
8006.11	buffet platter, laminated plastic	54	8080.04	buffet stand "Basic", 18/10	50	8205.36	buffet display "V12", carbon	44
8006.13	buffet platter, laminated plastic	54	8080.08	buffet stand "Basic", 18/10	50	8206.08	buffet display "V12", carbon	44
8008.01	buffet platter, glass	61	8080.16	buffet stand "Basic", 18/10	50	8206.16	buffet display "V12", carbon	44
8008.02	buffet platter, glass	61	8080.24	buffet stand "Basic", 18/10	50	8206.24	buffet display "V12", carbon	44
8008.03	buffet platter, glass	61	8081.13	buffet stand "Squareline", 18/10	16	8207.24	buffet display "Carbon 4.0"	44
8008.04	buffet platter, glass	61	8081.13C	buffet stand "Squareline", 18/10, copper	16	8207.36	buffet display "Carbon 4.0"	44
8008.05	buffet platter, glass	61	8081.13G	buffet stand "Squareline", 18/10, golden	16	8210.04D	buffet display "Konkret!", fibreglass	48
8008.06	buffet platter, glass	61, 199	8081.25	buffet stand "Squareline", 18/10	16	8210.08D	buffet display "Konkret!", fibreglass	48
8008.07	buffet platter, glass	61	8081.25C	buffet stand "Squareline", 18/10, copper	16	8210.12D	buffet display "Konkret!", fibreglass	48
8008.08	buffet platter, glass	24, 61, 97	8081.25G	buffet stand "Squareline", 18/10, golden	16	8210.16D	buffet display "Konkret!", fibreglass	48
8008.13	buffet platter, glass	61	8082.13	buffet stand "Squareline", 18/10, black	16	8210.20D	buffet display "Konkret!", fibreglass	48
8011.12	buffet stand "Antique", poly resin	35	8082.25	buffet stand "Squareline", 18/10, black	16	8210.04L	buffet display "Konkret!", fibreglass	48
8011.24	buffet stand "Antique", poly resin	35	8083.01	acrylic adapter "Squareline"	16	8210.08L	buffet display "Konkret!", fibreglass	48
8011.36	buffet stand "Antique", poly resin	35	8083.02	acrylic adapter "Squareline"	16	8210.12L	buffet display "Konkret!", fibreglass	48
8013	buffet etagere "Stablo", 18/10	25	8084.13	buffet stand "Squareline", 18/10, white	16	8210.16L	buffet display "Konkret!", fibreglass	48
8014.13	buffet stand "Stablo", 18/10	22	8084.25	buffet stand "Squareline", 18/10, white	16	8210.20L	buffet display "Konkret!", fibreglass	48
8014.20	buffet stand "Stablo", 18/10	22	8104	LED-light	38	8212.D	XXL-bowl "Konkret!", fibreglass	49
8015.20	buffet stand "Stablo", S, 18/10	22	8104.UK	LED-light	38	8213	stand f. XXL-bowl "Konkret!", steel	49
8015.30	buffet stand "Stablo", M, 18/10	22	8104.USA	LED-light	38	8220.08	buffet display "Pearl", shell imitation	34
8015.40	buffet stand "Stablo", L, 18/10	22	8105.01	color cover, blue	38	8220.16	buffet display "Pearl", shell imitation	34
8016	buffet stand "Stablo", XL, 18/10	22	8105.02	color cover, yellow	38	8220.24	buffet display "Pearl", shell imitation	34
8016.01	buffet stand "Stablo" XL-ring, 18/10	23	8105.03	color cover, green	38	8230.08	buffet display "Classy", resin	31
8017.40	extension "Stablo", 18/10	22	8105.04	color cover, red	38	8230.16	buffet display "Classy", resin	31
8017.60	extension "Stablo", 18/10	22	8120.01	acrylic glass tube	38	8230.24	buffet display "Classy", resin	31
8017.80	extension "Stablo", 18/10	22	8120.02	acrylic glass tube	38	8231	buffet display "Classy", resin	30
8018.01	fingerfood tree, 18/10	103	8120.03	acrylic glass tube	38	8300.10	buffet stand "Skyline", 18/10	8
8018.02	fingerfood tree, 18/10	103	8122.10	acrylic glass tube	8, 38	8300.22	buffet stand "Skyline", 18/10	8
8018.T	transport bag	103	8122.22	acrylic glass tube	8, 38	8300.34	buffet stand "Skyline", 18/10	8
8019.01	spring clip support, 18/10	102	8122.34	acrylic glass tube	8, 38	8300.58	buffet stand "Skyline", 18/10	8
8019.02	ring support, 18/10	102	8122.58	acrylic glass tube	8, 38	8305.10	buffet stand "Skyline", 18/10	8
8019.03	ring support, 18/10	102	8130	LED tealight set	283	8305.22	buffet stand "Skyline", 18/10	8
8019.04	ring support, 18/10	102	8131	LED tealight	283	8305.34	buffet stand "Skyline", 18/10	8
8019.05	spiral support, 18/10	102	8132.EU	power supply	283	8305.58	buffet stand "Skyline", 18/10	8
8020	buffet platter 1/1 GN, slate	53	8132.UK	power supply	283	8310.22	buffet stand "Curve", steel	19
8022.01	marble platter	98, 242	8132.US	power supply	283	8310.46	buffet stand "Curve", steel	19
8022.02	marble platter	98, 242	8150	rechargeable LED-light	39	8311.22	buffet stand "Curve", steel	18
8028	sushi platter, granite	181	8151	remote control	39	8311.46	buffet stand "Curve", steel	18
8034	bowl, granite	118, 241	8152.EU	charging devise	39	8730	buffet bridge "Podia"	27, 295
8035	sushi platter, granite	180	8152.UK	charging devise	39	8731	buffet bridge "Podia"	26, 295
8037	mortar, marble	241, 278	8152.US	charging devise	39	8732.01	2/8 GN-tray, genuine wood verneer	27, 295
8038	mortar, marble	241, 278	8200.12D	buffet display "Konkret!", fibreglass	48	8732.02	1/2 GN-tray, genuine wood verneer	27, 295
8042	skewer plate, slate	242	8200.24D	buffet display "Konkret!", fibreglass	48	8732.03	1/2 GN-tray, genuine wood verneer	27, 295
8043.01	slate saucer	280	8200.36D	buffet display "Konkret!", fibreglass	48	9639.03	liquid chalk marker	304
8043.02	slate saucer	280	8200.12L	buffet display "Konkret!", fibreglass	48	9640.F5	liquid chalk marker	304
8045	slate saucer	242	8200.24L	buffet display "Konkret!", fibreglass	48	9640.05	liquid chalk marker	304
8046	slate platter	242	8200.36L	buffet display "Konkret!", fibreglass	48	9641.01	liquid chalk marker	304
8047	slate platter	242	8201	wine cooler, fibreglass	10			

Zieher "Selection" consists of an exclusive choice of innovative products, which are now made accessible to the high class retail market and thus becoming available for every design favouring end user with a sense for the extraordinary. These items are delivered in gift boxes.

2103.03PB	etagere, 18/10	93, 271
2106.04PB	etagere, 18/10	92, 270
2109.PB	bowl "Loop", 18/10	83
2159.16PB	bowl, 18/10	85, 239
2159.20PB	bowl, 18/10	85, 239
2180.22PB	bowl, 18/10	84
2180.30PB	bowl, 18/10	84
2189.PB	etagere/pastry stand, 18/10	273
2198.PB	etagere, 18/10	87
2200.PB	XXL bowl, incl. illumination, 18/10	89
2261.16PB	bowl "Shine", ivory, 18/10	72
2261.20PB	bowl "Shine", ivory, 18/10	72
2261.24PB	bowl "Shine", ivory, 18/10	72
2336.PB	bowl/basket "Reef", pewter	67
2381.38PB	bowl "Roots", brass	68, 293
4230.14PB	fruit/dessert bowl "Spobo", china	164
4230.18PB	soup bowl "Spobo", china	164
4375.01PB	bowl "Cave", china	173, 235
4386.PB	plateau plate "DressCoat", china	151
4387.PB	plateau plate "DressCoat", china	151
4388.PB	plateau plate "DressCoat", china	151
4389.25PB	plateau plate "Cuspis", china	144, 188
4399.PB	wind light w. saucer, biscuit	282
4461.01PB	porcelain pillow "Donna"	142

4461.02PB	porcelain pillow "Donna"	142
4501.PB	platter "Collina", china	157
4504.PB	platter "Collina", china	157
4595.45PB	tray "Slope", melamine	127, 259
4596.45PB	tray "Slope", melamine	127, 259
4707.PB	serving tray "Solid", walnut	108, 256, 284
4732.PB	cutting board "Solid", walnut	110
4772.33PB	wooden pillow "Donna", walnut	143,
4773.PB	bed tray, walnut	113, 255, 287
4774.31PB	cutting board "Connect!"	112, 254
4775.44PB	cutting board "Connect!"	112, 254
4882.22PB	cloche w. wooden saucer	117, 189, 253
4882.30PB	cloche w. wooden saucer	117, 189, 253
4884.PB	decanter "Eddy" w. ring	209
4914.PB	glass miniature "Amuse"	218
4915.PB	glass miniature "Amuse"	218
4918.PB	glass tin "Amuse"	219
4919.PB	glass tin "Amuse"	219
4920.PB	glass tin "Amuse"	219
4921.PB	glass tin "Amuse"	219
4923.PB	nut bowl "Amuse", glass	220
4924.01PB	glass miniature "Amuse"	216
4924.02PB	glass miniature "Amuse"	216
4943.08PB	glass cloche w. porcelain saucer	144, 188, 213



ZIEHER
selection

4943.10PB	glass cloche w. porcelain saucer	144, 188, 213
4943.25PB	glass cloche w. porcelain saucer	144, 188
4944.PB	honey spoon w. glass rest "Cuspis"	212, 237
4954.03PB	small bowl "Halfmoon", glass	223
4956.02PB	bowl, glass	223
4956.03PB	bowl, glass	223
4956.04PB	bowl, glass	223
5135.PB	glass tray w. bowls	166, 178, 277
5170.PB	sushi set, glass	181, 183
5446.01PB	glass pillow "Donna"	143, 234, 291
5480.01	FRESH	206
5480.02	STRAIGHT	206
5480.03	INTENSE	206
5480.04	BALANCED	207
5480.05	RICH	207
5480.06	NOSTALGIC	207
5481	champagne flute "Vaganza", transparent	202
5481.GPB	champagne flute "Vaganza" golden	202
5481.PPB	champagne flute "Vaganza" platinum	202
7109.46PB	bowl "Capiz", shell	71
8070.01PB	wine cooler w. stand "Stablo"	22

A	
acrylic adapter "Squareline"	16
acrylic insert for wine cooler	11
acrylic tubes	8, 38
ahstray for cigars	100, 230, 283
"Amuse"	216-220
amuse gueule/tapas spoon, china	
	137, 172, 235, 240
"Antique"	35
anti-slip mats "Modul"	130
anti-slip pads	210
"Art de Buffet"	81-99
"Artisan"	78, 79, 198, 238
ash tray, glass	100, 230, 283

B	
BALANCED	207
banquet stand	100
base station for rechargeable LED-light	39
base trays "Modul"	24, 132, 134
"Basic"	50, 51
basket "Marcato"	104, 105
baskets/bowls "Reef"	66, 67
bed tray "Solid", walnut	113, 255, 287
bill folder	304
black glass	58, 176, 178-180, 276
borosilicate glass	186, 188-193, 212-224, 281
bottles with catch, glass	228
bottles, glass	11, 228, 229, 263, 264, 278, 279
bowl "Capiz"	71, 174, 292
bowl "Cuspis"	144, 188
bowl, granite	241
bowl "Loop"	83
bowl "Matrix"	68, 293
bowl "Roots"	68, 293
bowl "Shine", stainless steel	72
bowl XXL	49, 89
bowl/basket „Reef“	66, 67, 294
bowl/display „Fakir“	68, 257
bowls "Pueblo", stoneware	70, 152, 234
bowls "Shine", stainless steel	72
bowls "Solid", walnut	114, 250
bowls, china	
	111, 119, 136, 137, 162-166, 172, 236, 275
bowls, glass	73-77, 118, 179, 180,
	182-185, 192, 222, 223, 224, 230, 275
bowls, stainless steel	
	72, 78-95, 111, 169, 238, 239

boxes "Amuse", glass	219
boxes "Solid", walnut	
	112, 246, 249, 262, 284, 288
boxes, glass	154, 227, 263-264
bread basket/box "Solid", walnut	114, 249, 251
bread basket/pastry bowl, stainless steel	
	78, 80, 90, 238
bread cutting board "Solid", walnut	
	110, 112, 254
bread/fruit basket "Skyline"	10
bread/fruit basket, stainless steel	90, 94
bridge, melamine	122, 134
bridge, wood	26, 27, 111, 132
buffet bowl "Capiz"	71
buffet bowl "Duplex"	73
buffet bowl "Loop"	83
buffet bowl "Matrix"	68, 69
buffet bowl "Roots"	68, 69
buffet bowl "Shine"	72
buffet bowls "Fakir"	68, 69
buffet bowls "Pueblo"	70, 152, 234
buffet bowls "Reef", pewter	66, 67, 294
buffet bowls, brass	68, 69
buffet bowls, china	162, 163
buffet bowls, glass	73-77, 185
buffet bowls, shell	71
buffet bowls, stainless steel	72, 82-90, 94, 95
buffet bridges „Podia“	26, 27, 295
buffet columns	35, 38
buffet columns "Antique"	35
buffet display "Carbon 4.0"	44
buffet display "Classy"	30, 31
buffet display "Konkret!"	48
buffet display "Mercato"	104
buffet display "Neo"	32, 33
buffet display "Pearl"	34
buffet display "Solid"	41, 115, 132
buffet display "V12"	44
buffet etageres	
	25, 84-87, 91-93, 96, 97, 118, 269, 270, 271, 273
buffet platters, overview	52
buffet platters, black glass	58

buffet platters, china	157
buffet platters, glass	
	24, 49, 56-61, 62, 76, 77, 96, 97, 184
buffet platters, grey glass	60
buffet platters, laminated plastic	54, 55
buffet platters, marble	98
buffet platters, satined	56
buffet platters, slate	53
buffet platters, structured glass	61
buffet platters, transparent	57
buffet platters, white glass	59
buffet sign	100
buffet stands "Basic"	50
buffet stands "Curve"	18, 19
buffet stands "Skyline"	8, 9
buffet stands "Squareline"	16
buffet stands "Stablo"	22, 23
buffet stands "U-Turn"	40
buffet stands, stainless steel	
	8, 9, 16, 22, 23, 25, 50, 94, 95

buffet steps	62, 63
buffet system "Antique"	35
buffet system "Basic"	50, 51
buffet system "Carbon 4.0"	42-44
buffet system "Cater-Log"	122
buffet system "Classy"	30, 31
buffet system "Curve"	18, 19
buffet system "Konkret!"	46-48
buffet system "Lightning Buffet"	36-39
buffet system "Neo"	32, 33
buffet system "Mercato"	104, 105
buffet system "Pearl"	34
buffet system "Skyline"	6-12
buffet system "Solid"	41
buffet system "Squareline"	13-17
buffet system "Stablo"	20-25
buffet system "U-Turn"	40
buffet system "V12"	42-44
buffet systems overview	28, 29
buffet trays, stainless steel	
	79, 82, 90, 91, 93, 96, 97
butane gas cartridge	303
butter/lard pot	229

C	
cake/pastry stand	116, 195, 273
candle holder/tealight	227, 272, 280-283
"Capiz"	71, 174, 175, 201, 257, 292
"Carbon 4.0"	44
card holders	100
"Catering"	162
"Catering de Luxe"	163
"Cater-Log"	122
"Cave"	173, 235
caviar cooler	94, 185, 225
CD fuel	303
champagne bowl	49, 71, 80, 88, 89
champagne flute "Vaganza"	202
champagne/wine cooler	10, 23, 49, 71
china ball "oro79"	160
china bowls	136, 137, 162-166
china creamer	226, 233
china cups	162
china mini bowls	139, 226, 232-236, 263-265
china miniatures	
	124, 125, 213, 214, 226, 232-235, 263-267, 275, 277
china plates	
	150-154, 158, 160, 162, 163, 168, 173, 235, 302
china platter "Collina"	157
china platter "Dots"	154
china platters	120, 146-148, 160, 162
china series "Catering de Luxe"	163
china series "Catering"	162
china series "Duo"	166
china series "Flora"	302
china series "Modul"	136, 137, 172-173
china series "oro79"	160
china series "Plat de Luxe"	158, 159
china series "Rough!"	146, 147
china series "Saturn"	302
china series "SelectionA."	168-170
china series "Spobo"	164, 165
china spoon	240
china trays	260
chocolate/ice cube tongs	80, 99, 246
chocolate insert "Solid"	244, 289
chocolate/pastry platter, stainless steel	91
chocolate/ truffle box "Solid"	246
"Choice"	118
cigars insert "Solid"	244, 289

"Classy"	30, 31
cloches, glass	
	23, 102, 116, 117, 144, 156, 188-195, 216, 230
coat rack "Kibu"	296
cocktail glass	207, 222
coffee cups, china	162, 302
"Collina"	156, 157
colour covers for LED-light	38
"Connect!"	112, 254
connector piece "Solid"	106
cork	139, 224, 228, 263, 278
Coup plate, china	162
creamer	154, 226-229, 233, 235
creamer „Amuse“, glass	220
creamer china	124, 162, 226, 233, 235, 266
creamer, glass	220, 227-229
cruet stands, stainless steel	261, 265, 266, 267
cups, china	162
"Curve"	18, 19
"Cuspis"	144, 145, 188, 212, 213
cutlery insert "Solid", walnut	109
cutlery/napkin box, melamine	115, 126, 138
cutlery/napkin box, wood	115, 248, 284
cutlery series "Goa"	300
cutlery series "Mao"	298, 299
cutting board "Connect!"	112, 254
cutting board, walnut	110, 112, 254

D	
decanter "Eddy"	209
decanter, glass	11, 186
dessert/fruit bowl "Spobo"	164
dinner plates	162, 168, 195, 197-201
dinner plates, china	162, 168, 200
dinner plates, glass	
	57, 58, 59, 71, 114, 177, 195, 198, 199, 250
dinner plates, laminated plastic	199
dinner plates, shell	174, 175, 201
dinner plates, slate	53, 198
dinner plates, stainless steel	78, 90, 195, 198
dip bowls	139, 234
display "Move"	120
display for small bowls "TriBo"	119
display/bowl "Fakir"	68, 257
dividing plate "Milky"	49, 89
"Donna"	142, 143, 290, 291
"Dots"	154
double-walled bowls	119, 218, 222, 223
double-walled glasses	222, 223, 265
"DressCoat"	150, 151, 234, 282
dressing ladle	100, 298
dressing/jam jar	86, 99, 100
"Duo"	166
"Duplex"	73
E	
"Eddy"	209
egg cup	162, 233, 266
etageres	
	25, 79, 84-87, 91-93, 96, 97, 118, 239, 269-273
extension "Stablo"	22

F	
"Fakir"	68, 69, 257
fingerfood tree	101-103
fingerfood tree, equipment	102, 103
"Flow"	171, 224
fondue insert	163, 169, 222
fondue set, 2 parts	163
food display, stainless steel	268
FRESH	206
fruit/bread basket "Reef"	66, 67
fruit/bread basket "Skyline"	10
fruit/bread basket "Solid"	114, 251
fruit/bread basket, stainless steel	90, 94
fruit/dessert bowl "Spobo"	164

G	
gas blowlamp	303
glass bottles	
	11, 176, 228, 229, 263, 264, 278, 279
glass bowls	73-77, 118, 179, 180,
	182-185, 192, 222, 223, 224, 230, 275
glass boxes	154, 227, 263, 264
glass boxes "Amuse"	219
glass cloche with china saucer	144, 188, 213
glass cloche with wooden saucer	117, 189, 253
glass cloches	102, 116, 117, 144, 156,
	169, 188-195, 213, 216, 252, 253
glass coaster	212, 237

glass cone "Lacuna"	215
glass cones	102, 215, 231, 268
glass decanter	11, 186, 209
glass inserts	114, 189-193, 250, 252, 253
glass miniatures	98, 124, 125, 139, 212-225,
	227, 230, 232, 237, 263-267, 275-277
glass pillow „Donna“	143, 234, 290
glass plates	77, 137, 172, 176, 177, 182,
	184, 191, 198, 199, 236, 271
glass platters	56-61, 62, 96, 97, 108, 177,
	178, 180-185, 227, 231, 256, 257, 284, 286, 288
glass saucer	252, 253
glass series "Amuse"	216-220
glass series "VISION"	203-209
glass spoon "Cuspis"	212, 240
glass stand for buffet steps	63
glass stand for glass cloche	194
glass steps	62, 63
glass straw	214, 222
glass trays	25, 62, 76, 77, 178, 184, 190, 276
glass tubes "Sauce Flow"/"Soup Flow"	171, 224
glass wind lamp	281
glass with catch	228
glass, double-walled	222, 223, 266, 267, 275
GN trays	27, 122, 124, 274, 286
GN trays, genuine wood veneer	295
GN trays, melamine	122, 124, 274
"Goa"	300
granite bowls	241
granite sand	303
grate "Solid", walnut	109, 110
gray glass	60, 73, 76, 77, 182, 183

H	
"Halfmoon"	223
ham holder „Solid“	111
hanging spoon	240
holder for table numbers	100
holder for test tubes	139, 214, 224
holster for waiter's wallet	304
honey spoon "Cuspis"	212, 237, 240
honey spoon with glass plate "Cuspis"	212, 237
hook and loop strap for fingerfood tree	103
I	
"Ice"	177
ice bucket "Neo"	32
ice bucket, glass	186
ice cube/chocolate tong	80, 99, 246
insert for chocolates "Solid"	244, 289
insert for cigars "Solid"	244, 289
insert for coffee capsules "Solid"	244, 289
insert for saucer "Solid", glass	252, 253
insert for serving tray "Solid", walnut	108, 109
insert for tray "Solid", glass	108, 250, 288
insert for wine cooler "Skyline"	11
insert/platter "Solid"	108, 109, 244, 289
INTENSE	206

J	
jam-trays	227, 238, 261, 272
jam/dressing jar	86, 99, 100
jam/suger jar, glass	119, 229
juice glass	230
juice jug	186

K	
"Kibu" coat rack	296
"Konkret!"	46-49

L	
"Lacuna"	215
laminated plastic platters	54, 55
lard pot	229
latte macchiato glass	222
LED- tealight/set/equipment	283
LED-light, cabled	38
LED-light, equipment	38, 39
LED-light, rechargeable	39
"Lightning Buffet"	36-39
liquid chalk markers	304
longdrink glass	222
"Loop"	83

M	
"Mao"	298, 299
marble platter	98, 242
"Matrix"	68, 69
melamine bridge	134

melamine cutlery/napkin box	115, 126, 138
melamine spoon rest	134, 138
melamine stacking frame "Cater-Log"	122
melamine trays	122-127, 134, 274, 296
"Ménage-à-trois"	265
"Mercato"	104, 105
mini bowl "Cuspis"	144, 188, 213
mini bowl "Lacuna"	215
mini bowls, china	139, 154, 162, 173, 190, 214, 226, 232-235, 236, 263-265, 277
mini bowls, glass	111, 119, 138, 139, 154, 165, 168, 169, 179, 184, 185, 190-194, 216, 227, 230, 232, 237, 263, 264, 277
mini fork/spoon	240
mini pick spoon	240
miniature plates	233, 235, 270
miniature clothes	190-194, 216
miniatures	212-243
miniatures, stainless steel	238-239
minitures, china	98, 124, 125, 139, 162, 190, 214, 226, 232-235, 263-267, 270, 275, 277
minitures, glass	98, 102, 124, 125, 139, 154, 165, 190, 212-232, 237, 263-267, 270, 275-277
"Modul"	131-139, 172-173, 236
"Modul", melamine	122, 134, 138
"Modul", walnut	132, 133
mortar, marble	241, 278
"Move"	120, 236
N	
napkin/cutlery box, melamine	115, 126, 138
napkin/cutlery box, wood	115, 248, 284
"Neo"	32, 33
NOSTALGIC	207
nut bowl "Amuse"	220
O	
oil/dip bowl	234
"oro79"	160
P	
party spoon, china	240
party spoon, stainless steel	138, 24
pasta plate, china	163, 302
pasta plate, stainless steel	90
pastry/bread bowl, stainless steel	78, 80, 90, 238
pastry/cake ladle	100, 298
pastry/cake stand	116, 195, 273
pastry/chocolate platter, stainless steel	91, 269
"Pearl"	34
pepper mill	263, 303
pie/pastry server	100, 298
pillow "Donna", china	142, 234
pillow "Donna", glass	143, 234, 290
pillow "Donna", wood	143, 291
"Plat de Luxe"	158, 159, 200
plate "Pueblo", stoneware	152
plate, china	146, 147, 150-154, 158, 160, 162, 163, 168, 173, 190, 200, 236, 302
plate, glass	77, 137, 172, 176, 177, 182, 183, 184, 191, 198, 199
plate, stainless steel	90, 195, 198
plate/saucer, wood	117, 189, 191-193, 252, 253
plateau plate "Cuspis", china	144, 188, 213

plateau plate "DressCoat", china	150, 151, 234, 282
platter "Collina"	157
platter "Dots"	154
platter "Ice"	177
platter "Rough!"	146, 147
platter "Velo"	148
platter, china	120, 146-148, 160, 162
platter, glass	56-61, 62, 96, 97, 108, 177, 178, 180-185, 227, 231, 256, 257, 284, 286, 288
platter, laminated plastic	54, 55, 199
platter, marble	98, 242
platter, slate	53, 242, 243
platter/insert "Solid"	244, 289
"Podia"	26, 27, 295
porcelain pillow "Donna"	142, 234
presentation box "Solid"	244, 288, 289
"Pueblo"	70, 152, 234
R	
rack for XXL bowl "Konkret!"	49
rechargeable LED-light	39
"Reef"	66, 67, 294
remote control for rechargeable LED-light	39
replacement grate "Solid", walnut	110
RICH	207
ring support for fingerfood tree	102
rings "SelectionA.", silicone	23, 169, 185, 194, 209, 230
roomservice tray "Solid", walnut	113, 255, 287
"Roots"	68, 69
"Rough!"	146, 147
S	
salad bowls, china	302
salad servers/tongs	99, 100,
salt/pepper mills	263, 303
sauce bowl	233, 235
"Sauce Flow"	171
sauce/soup ladle	298
saucer "Solid"	68, 117, 189, 191, 252, 253, 257
saucer, slate	242, 280
saucer, china	162, 191, 194, 233, 282, 302
saucer, glass	68, 252, 253, 257
saucer, natural stone	242, 280
saucer, silicone	210
saucer, wood	117, 189, 191-193, 252, 253
saucers	235
"SelectionA."	167-170
servers "Goa"	100, 300
servers "Mao"	100, 298
serving etageres	269, 270, 271, 273
serving fork/spoon	100, 298
serving tongs	80, 99
serving trays	108, 109, 122, 132, 134, 250
serving trays, melamine	122, 127, 134
serving trays, wood	108, 109, 112, 132, 250, 256, 284
shell displays "Pearl"	34
shell series "Capiz"	71, 174, 175
"Shine"	72
side order dishes	162, 212-239
side order/tapas bowls	162, 233, 235
side table/tray stand "Solid"	286

silicone coasters	210
silicone holder for test tubes	224
silicone pads	210
silicone rings "SelectionA."	23, 169, 230
silicone sleeve	9, 16, 96, 130, 210
"Sixth Sense"	82
skewer platter, slate	242, 243
skewers, stainless steel	98, 138, 163, 240, 242, 243
"Skyline"	6-12
slate platters	53, 242, 243
slate saucers	242, 280
"Slope"	127, 258, 259, 296
small creamer, china	124, 226, 233, 235
small creamer, glass	227-229
small glass bowl "Lacuna"	215
small glass bowls	111, 119, 138, 139, 154, 165, 168, 169, 179, 184, 185, 190-194, 216, 227, 230, 232, 263, 264, 277
"Solid"	41, 106-117, 189, 191-193, 244-257, 284-289
soup cup/bowl	162, 164, 166, 302
"Soup Flow"	171
soup/sauce ladle	100, 298
spiral support for fingerfood tree	102
spiral support for miniatures	98
"Spobo"	164, 165
spoon rest, melamine	122, 134, 138, 274
spoon rest, wood	132
spoon rests	99, 100, 183
spoon, china	240
spoon, glass	212
spring clip support for fingerfood tree	102
"Squareline"	13-17
stacking frame, melamine "Cater-Log"	122
"Stablo"	20-25
stainless steel bowls	72, 78-95, 111, 238, 239
stainless steel cruet stands	261, 266, 267, 278
stainless steel etageres	25, 79, 84-87, 91-93, 96, 97, 118, 239, 269-273
stainless steel plates	90, 195, 198
stainless steel skewers	138, 242
stainless steel tongs	80, 99
stainless steel trays	25, 79, 82, 90, 91, 93, 96, 97, 261, 269, 273
stainless steel, hammered	8-11, 81-99
stand for buffet steps	63
stand for trays "Solid"	106, 286
steps, glass	62, 63
stoneware series "Pueblo"	70, 152
storage box "Solid"	244, 288, 289
STRAIGHT	206
strap for fingerfood tree	103
straw, glass	214, 222
sugar bowl, glass	119, 229
sushi platter	180, 181
sushi platter, glass	180, 181
sushi platter, granite	180
sushi platter, stainless steel	91
sushi set	181, 183
T	
tapas spoon	137, 235, 240
tapas bowls	162, 212-239

tea-set, double walled glass	186
tealight holder/candle holder	272, 280-283
test tube	139, 224
three-part platter/trays	124, 125, 276
toast stand, stainless steel	91, 269
tongs holder, stainless steel	99
tongs, stainless steel	80, 99
transport bag for fingerfood tree	103
tray inserts "Solid"	108, 109
tray stand/side table "Solid"	286
tray stands "Solid"	106, 286
trays for jam	272
trays, glass	25, 62, 184, 178, 276
trays, wood	24, 108, 109, 112-114, 132, 249, 250, 256, 262, 287, 288
trays, china	260
trays, melamine	24, 122-127, 134, 259, 274, 296
trays, stainless steel	25, 79, 82, 90, 91, 93, 96, 97, 261, 269, 273
"TriBo"	119
tubes "Sauce Flow"/"Soup Flow", glass	171, 224
tubes, acrylic glass	8, 38
U	
"U-Turn"	40
V	
"Vaganza"	202
"Vario"	184
"Velo"	148
vinegar/oil bottle, glass	267, 278, 279
"VISION"	203-208
"V12"	44
W	
waiter's wallet	304
walnut adapter "Squareline"	16
walnut bowls "Solid"	114
water glass	207, 222, 230, 275
white glass	59
wine glasses "VISION"	203-208
wine/champagne cooler	10, 23, 49, 71, 80, 88, 89
wine decanter/carafe "Eddy"	209
wind lights	191, 192, 280-283
"Wings" bowl	83
wooden bowls	250, 251
wooden boxes "Solid"	246-249, 262, 288, 289
wooden bridges	26, 27, 111, 132
wooden pillow "Donna"	143, 291
wooden plates/saucer	252, 253
wooden trays/platters	108, 109, 112-114, 132, 249, 250, 252, 253, 256, 262
X	
XXL bowl, concrete semblance	49
XXL bowl, stainless steel	89

GENERAL CONDITIONS

This catalogue is valid as of March 1st, 2017. Any catalogues and price lists issued previously become invalid as of that date. This catalogue is valid until February 28th, 2018. Misprints and errors excepted. Colour deviations from photographs reserved. All indications of sizes or measurements are approximate ones and subject to alterations. The respective general terms of sale and delivery of our foreign partners apply. For a list of our foreign partners, please consult: www.zieher.com. Changes on technical specifications and terms of delivery of the products are reserved and need explicit, written confirmation by Zieher or the respective Zieher business partner. Photographs are protected by copyright law. Duplication, even in parts, as well as reproduction by photomechanical devices, transfer into systems of electronical data storage and data processing, and adoption of the catalogue layout as well as the use of its parts for advertisement purposes are prohibited and will be legally prosecuted as violations of the German copyright law or the law of competition respectively.

Individuality in glass ...



Logos, letterings etc. can be put on the double walled glasses to give them an individual touch. Those are applied onto the outer side of the inner glass which ensures the protection from dirt and abrasion.



... china ...



... and stainless steel!



Please ask us, we will gladly prepare an individual offer for you!

Stainless steel refinement through PVD-technology

Highly polished and matt stainless steel can be refined by using PVD-technology to obtain golden, copper and black colouring.

PVD stands for **Physical Vapour Deposition** and describes a method to coat products with different materials by way of sputtering in a vacuum. Contrary to the galvanic refinement for example with copper, items refined by using PVD-technology will neither oxidise nor tarnish at the surface. Thus any copper refinement can be done without applying specific anti-tarnish protection.

The technical feasibility of the PVD-refinement depends on size and shape of the items and has to be checked individually mostly. Permanently available stainless steel items refined with gold and copper can be found on pages 9, 16 and 80.

Advantages of the PVD-coating

- Food-safe
- Dishwasher-safe
- Better strength and adherence compared to galvanic refinement
- Brilliant colouring, colourfast and resistant against UV radiation



stainless steel, polished

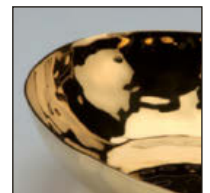

golden

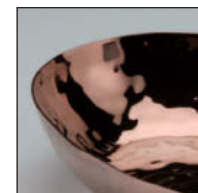

copper

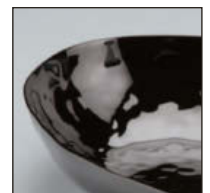

black



All information on refining china, glass and stainless steel can be found on pages 80 and 196.



The founders of the company Christa and Manfred Zieher with their sons Dominik and Oliver (on the right side). Dominik is responsible for the sale worldwide and Oliver for product development and design. Daughter Jennifer (not pictured) is responsible for the controlling.

ZIEHER

WWW.ZIEHER.COM



Our partners at work:
Thomas Dötzer (www.doetzers.de) and
photographer Gerd Preiß (www.die-lichtzeichner.de)

W W W . Z I E H E R . C O M



ZIEHER KG

Kulmbacher Str. 15
95502 Himmelkron
G E R M A N Y

Tel.: +49 9273 / 92 73 40
Fax: +49 9273 / 92 73 74
E-Mail: info@zieher.com

Valid until **February 28th, 2018**